



# HAKKO FR-810B

SMD REWORK STATION

## SMD Rework Station

# Instruction Manual

Thank you for purchasing the HAKKO FR-810B SMD Rework Station.  
 This unit features digital control and display of hot air temperature.  
 Please read this manual before operating the HAKKO FR-810B.  
 Keep this manual readily accessible for reference.

## 1. PACKING LIST AND PART NAMES

Please check to make sure that all items listed below are included in the package.

HAKKO FR-810B station.....	1	Power cord .....	1
Handpiece holder .....	1	Vacuum pipe control knob (L) (with tapping screw) .....	1
Pads (ø3 mm (0.12 in.), ø5 mm (0.20 in.), ø7.6 mm (0.3 in.))..	2 each	Instruction manual .....	1
Heat resistant pad .....	1	Temperature distribution chart .....	1

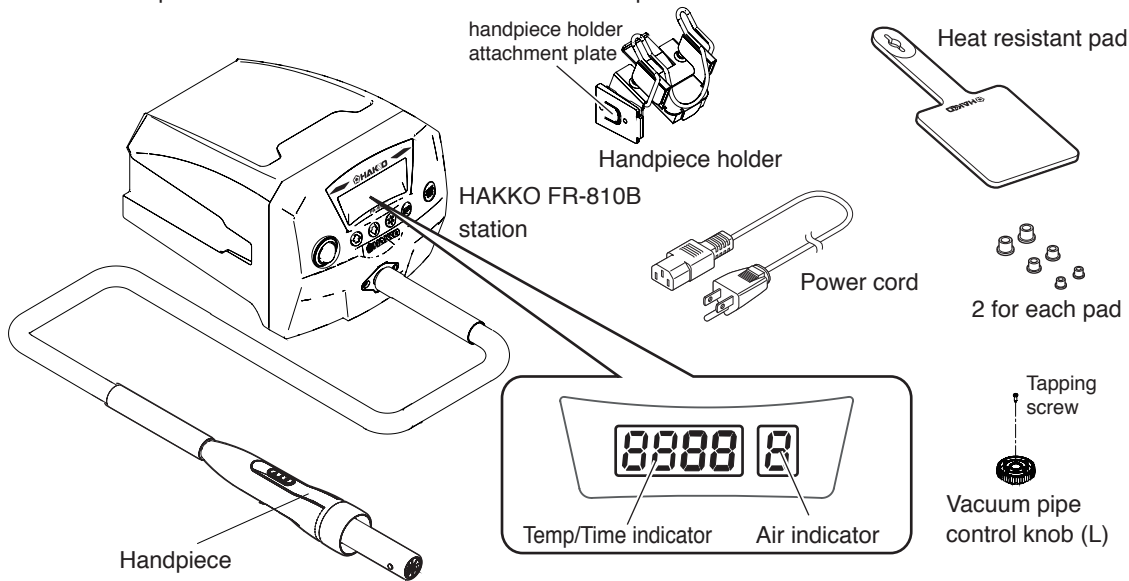

### ● Handpiece

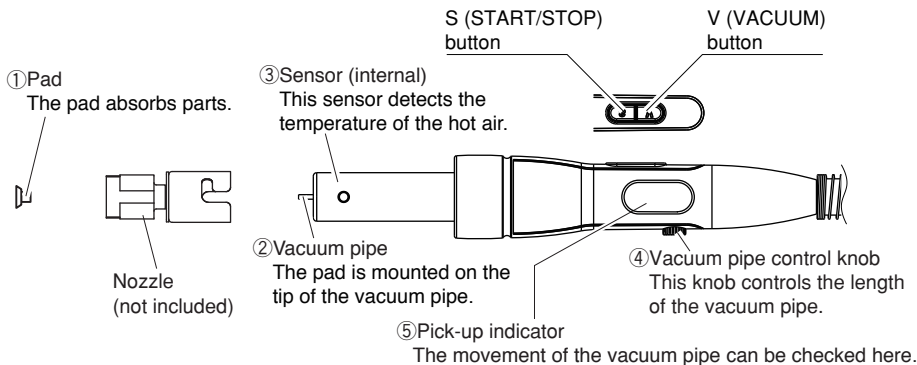

## 2. SPECIFICATIONS

	100V-700W 110V-840W 120V-820W 220V-1100W 230V-1200W 240V-1300W
--	---

### ● Handpiece

Power consumption	100V-670W 110V-810W 120V-790W 220V-1070W 230V-1170W 240V-1270W
Total length (w/o cord)	9.8 in. (250 mm)
Weight (w/o cord)	0.40 lb. (180 g)

\* This product is protected against electrostatic discharge.

\* Specifications and design are subject to change without notice.

※ 各言語（日本語、英語、中国語、フランス語、ドイツ語、韓国語）の取扱説明書は以下のURL、HAKKO Document Portalからダウンロードしてご覧いただけます。  
（商品によっては設定の無い言語がありますが、ご了承ください）

\* 各國語言(日語,英語,中文,法語,德語,韓語)的使用說明書可以通過以下網站的HAKKO Document Portal 下載參閱。  
（有一部分的產品沒有設定外語對應,請見諒）

\* Instruction manual for the language, Japanese, English, Chinese, French, German and Korean can be downloaded from the following URL, HAKKO Document Portal.  
(Please note that some language may not be available depending on the product.)



<https://doc.hakko.com>

### ⚠ CAUTION

This product includes such features as electrically conductive plastic parts and grounding of the handpiece and station as measures to protect the device to be soldered from the effects of static electricity. Be sure to observe the following instructions:

1. The handle and other plastic parts are not insulators, they are conductors. When replacing parts or repairing, take sufficient care not to expose live electrical parts or damage insulation materials.
2. Be sure to ground the unit during use.

### ● Station

Power consumption	30 W
Capacity (Airflow)	1 - 9 (5 - 115L/min*)
Control temperature	120 - 1120°F (50 - 600°C)
Outer dimensions	6.3 × 5.7 × 8.7 in. {160(W) × 145(H) × 220(D) mm}
Weight	3.3 lb. (1.5 kg)

\* Airflow capacity is rated as free flowing. Restrictions created by various nozzles may reduce the maximum airflow capacity.

### 中國RoHS: 產品中有毒有害物質或元素的名稱及含量

部件名稱	有毒有害物質或元素					
	鉛(Pb)	汞(Hg)	鎘(Cd)	六價鉻(Cr(VI))	多溴聯苯(PBB)	多溴二苯醚(PBDE)
電路板	×	○	○	○	○	○
動力單元	×	○	○	○	○	○
真空泵	×	○	○	○	○	○
插座	×	○	○	○	○	○

○ : 表示該有毒有害物質在該部件所有均質材料中的含量均在SJ/T 11363-2006標準規定的限量要求以下。  
 × : 表示該有毒有害物質至少在該部件的某一均質材料中的含量超出SJ/T 11363-2006標準規定的限量要求。

### 3. WARNINGS, CAUTIONS AND NOTES

---

Warnings, cautions and notes are placed at critical points in this manual to direct the operator's attention to significant items. They are defined as follows:

 **WARNING:** Failure to comply with a WARNING may result in serious injury or death.

 **CAUTION :** Failure to comply with a CAUTION may result in injury to the operator, or damage to the items involved.

**NOTE :** A NOTE indicates a procedure or point that is important to the process being described.

#### **WARNING**

To avoid damage to the unit, do not turn the power switch OFF until the pump stops automatically by cooling down after use and  appears on the display.

When powered, the temperature of the hot air and the nozzle will become extremely hot, reaching a maximum temperature of 1120°F (600°C). Be sure of the following to avoid possible **burns / fires** :

- Do not direct the hot air toward personnel or touch the metal parts near the nozzle.
- Do not allow the nozzle to come close to, or touch, flammable materials.
- Inform others in the area that the unit is hot and should not be touched.
- Turn the power off and allow the unit to cool when changing parts or storing the HAKKO FR-810B.
- The unit is for a counter or workbench use only.
- This appliance can be used by children aged from 8 years and above and persons with reduced physical, sensory or mental capabilities or lack of experience and knowledge if they have been given supervision or instruction concerning use of the appliance in safe way and understand the hazards involved.
- Children shall not play with the appliance.
- Cleaning and user maintenance shall not be made by children without supervision.

**To prevent accidents or damage to the HAKKO FR-810B, be sure to observe the following:**

#### **CAUTION**





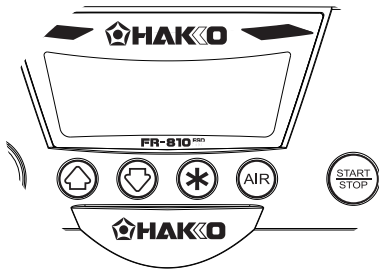

- Turn the power off when not in use, or left unattended.
- Do not strike the handpiece against hard surfaces or otherwise subject it to physical shock.
- Be sure the unit is grounded. Always connect power to a grounded receptacle.
- Do not modify the unit.
- Use only genuine HAKKO replacement parts.
- Do not allow the HAKKO FR-810B to become wet, or use it when hands are wet.
- Remove the power cord by holding the plug - not the cord.
- Be sure the work area is well ventilated.

# 4. INITIAL SETUP

## ● Controls and displays



The front panel of HAKKO FR-810B includes five operation buttons.

-  - Used to start or stop the station.
  - Pressing this button when the forced cool down bypass is enabled will turn the airflow off and stop the cooling process.
-  - Used for changing values.
  - Pressing this button when using Preset Mode will cause the preset selection screen to appear.
-  - Used for changing values.
  - Hold this button for at least two seconds to enter the Offset Mode.
-  - Used for finalizing entered values and checking settings.
  - Hold this button for at least two seconds to display the temp/timer screen.
-  - Used to set air flow.
  - When setting the airflow, you may press  or  to finalize your airflow setting value.

## A. Station assembly

### ● Attach the handpiece holder.

1. Turn and loosen the knob that locks the handpiece holder.
2. Slide the handpiece holder along the groove on the station in the direction of the arrow. Turn the knob to lock the handpiece holder in place.

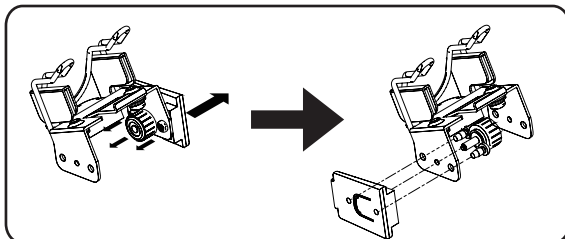
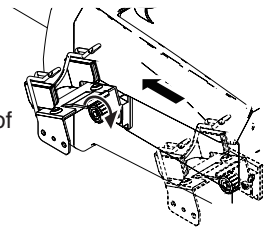

\* The handpiece holder can be attached to either side of the station by removing the handpiece holder attachment plate and attaching it to the opposite side of the handpiece holder.

## B. Handpiece

### ⚠ CAUTION

The nozzle and pad will be heated at high temperature. Cool them before replacement.

#### NOTE:

The handpiece can be used with the provided vacuum pipe control knob (L).

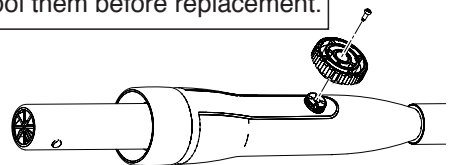

### ● Using vacuum function operative nozzle

#### 1. Attach the nozzle.

- a. Extend the vacuum pipe using the vacuum pipe control knob.
- b. Pass the vacuum pipe through the nozzle hole and attach the nozzle.

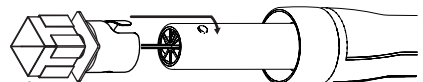

### ⚠ CAUTION

#### ● Vacuum pipe

Do not use excessive force. When not using a nozzle, retract the vacuum pipe to the shortest length.

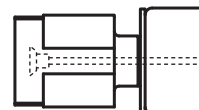

**2. Attach the pad.**

- a. Attach the pad.
- b. Adjust the pad to an appropriate position.  
Adjust the vacuum pipe so that the pipe and pad protrude as little as possible.

**⚠ CAUTION**

- Pad  
The pad does not last indefinitely. When it becomes deteriorated, replace it. Since exposure to high temperatures causes it to deteriorate faster, Hakko recommends it be cooled after use.

**● Using vacuum function inoperative nozzle {N51-01(G), N51-05(G), N51-06(G)}**

- 1. Retract the vacuum pipe to the shortest length using the vacuum pipe control knob.

**⚠ CAUTION**

The new N51-01/05/06 nozzle has a pipe guard inside. These nozzles could not be attached to HAKKO FR-810B when the vacuum pipe is extended. Do not use excessive force.

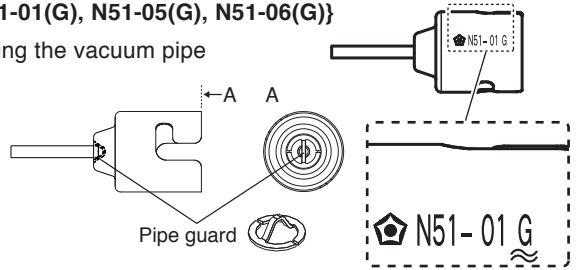

- 2. Tighten the nozzle mounting screw.

**⚠ CAUTION**

When "G" is not marked on the nozzle, these nozzles do not have space to blow hot air. using them with the HAKKO FR-810B may result in danger.

**NOTE :**  
Letter "G" is marked on the nozzle with the pipe guard.

**● How to Use a old nozzle**

Align the projection part, attach the old nozzle to the heater pipe.

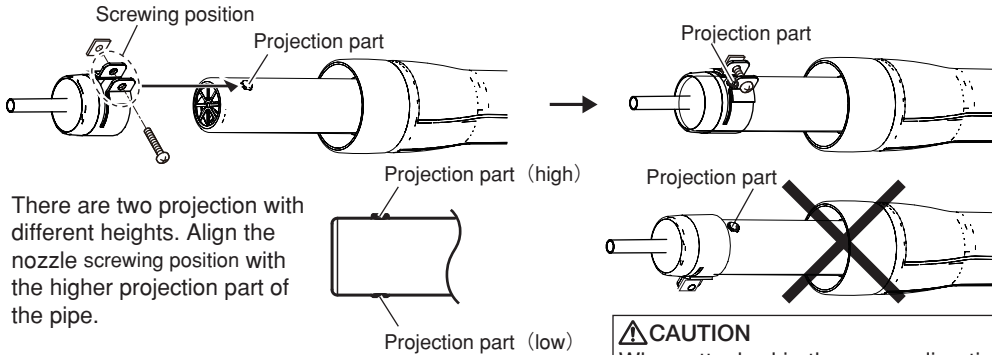

There are two projection with different heights. Align the nozzle screwing position with the higher projection part of the pipe.

※When using the QFP nozzle, remove the inside screw (M3 × 5) of the nozzle.



**⚠ CAUTION**

When attached in the wrong direction, the nozzle could not be fully inserted and can cause air leakage. Make sure to attach the nozzle in the correct direction.

**⚠ CAUTION**

**● Vacuum function inoperative nozzles. (Old nozzle)**  
A1124B, A1130, A1131, A1132, A1133, A1134, A1142B, A1183, A1190, A1191, A1192, A1325  
These nozzles could not be attached to HAKKO FR-810B when the vacuum pipe is extended. Do not use excessive force.  
A1124, A1142  
Do not use these nozzles with HAKKO FR-810B. These nozzles do not have space to blow hot air, using them with the HAKKO FR-810B may result in danger.

### C. Electrical connection and power ON

1. Insert the power cord into the receptacle on the rear panel of the station.
2. Place the handpiece on the holder.
3. Plug the other end of the power cord into a grounded wall socket.
4. Turn the power switch ON.

The rim of the handpiece must rest on the area circled in the illustration.

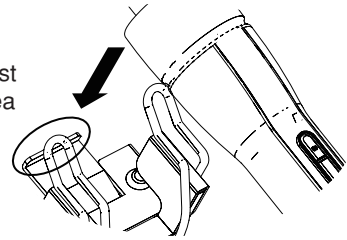

**CAUTION**  
When not in use, place the handpiece on the holder.

**CAUTION**  
This product is protected against electrostatic discharge. Be sure the unit is grounded.

## 5. OPERATION



### ● Air Blow

#### 1. Start

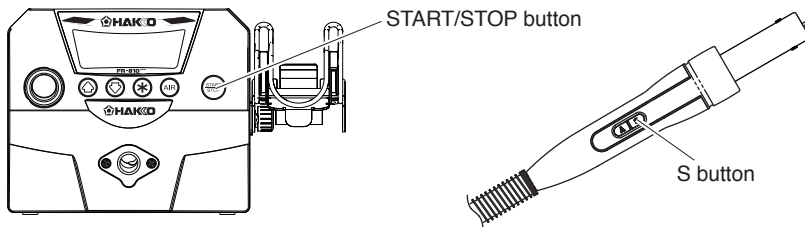
Press the “S” button on the handpiece or  (START/STOP) button on the station to start blowing air. Hot air blows out of the tip of the nozzle. Hot air temperature is controlled according to the temperature setting.



#### 2. Stop

Press the “S” or  button again. Power to the heater is shut off and cooling begins. When the temperature falls to 200°F (100°C), or after 1.5 minutes of cooling, air blow is automatically stopped. The display will show  indicating that the station is ready to start again.

### **WARNING**

Do not stop the hot air by turning the power switch OFF. If power is turned off after use, there will be no cool-down. To avoid damage to the equipment, do not turn the power switch OFF until  appears on the display.

### ● Setting of the air flow

Pressing the AIR button in the station causes the LED for AIR display to blink and allows you to change air flow. The air flow setting range is 1 to 9.

Actual airflow may be affected by the size and shape of the nozzle(s) used.

Example: Changing the air flow setting from 5 to 7

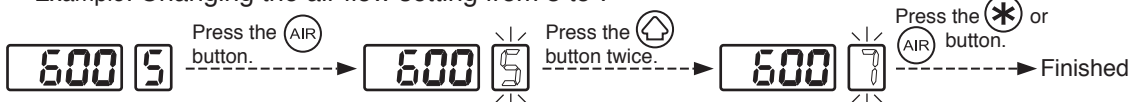

## ● Setting/Changing the Temperature and Timer

### NOTE:

After accepting the value for the ones digit for temperature, you will have the option to set the timer starting over with the hundreds digit.

The factory default : "Temperature 600°F" "Timer --- (No setting)"

Example : When the set temperature is 300°C and the timer setting is ---.

### 1. Setting the Temperature (from 600°F to 750°F)

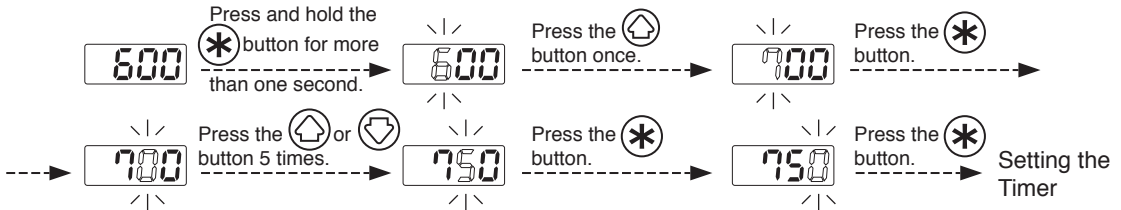

### 2. Setting the Timer (from --- to 130sec)

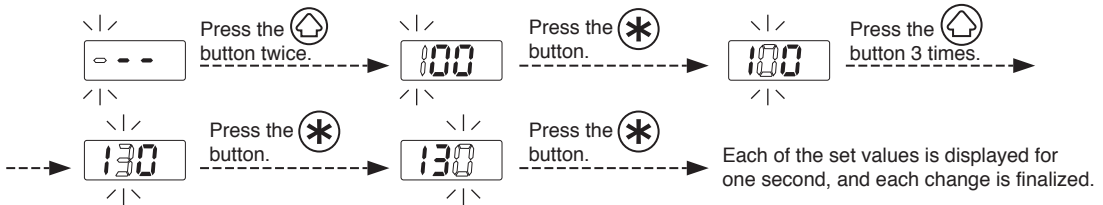

\* When you want to leave the timer "---".

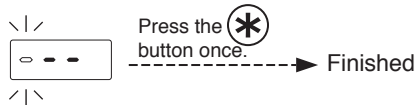

### ※Vacuum Function

Press the V (Vacuum) button on the handpiece. The vacuum pump turns ON and the part is held by suction.

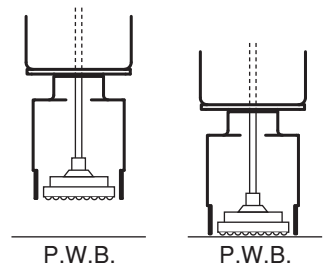
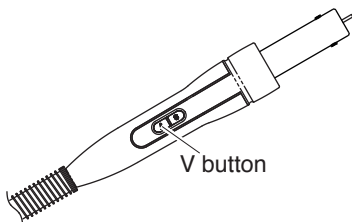

### \* Timer function

In this product, setting the timer allows you to control the time during which hot air is blown.

Either of the following two modes is selectable by parameter setting: Open Timing in which count is started from the time when temperature reaches the set temperature and Closed Timing in which count is started upon start. The timer setting range is 001 to 999 seconds.

(When not using the timer function, select "---". When set in the timer setting "000", don't work.)

## ● Preset mode

In addition to the procedure described remove above, HAKKO FR-810B includes a preset mode allowing the selection of temperature, time, and airflow from the options you define (up to 5 temperature/time/airflow settings can be programmed). Enter the parameter setting to change the mode.

(Please refer to [6. PARAMETER SETTING].)

Initial preset settings:

**P1** Temp. : 200°F Timer : "----" Air flow : 5

**P2** Temp. : 400°F Timer : "----" Air flow : 5

**P3** Temp. : 600°F Timer : "----" Air flow : 5

**P4** Temp. : 800°F Timer : "----" Air flow : 5

**P5** Temp. : 950°F Timer : "----" Air flow : 5

The initial number of active presets is set to 5 at the factory.

The default selected preset is set to **P3** at the factory.

Example : Changing preset selection from preset No. 3 to No. 1.

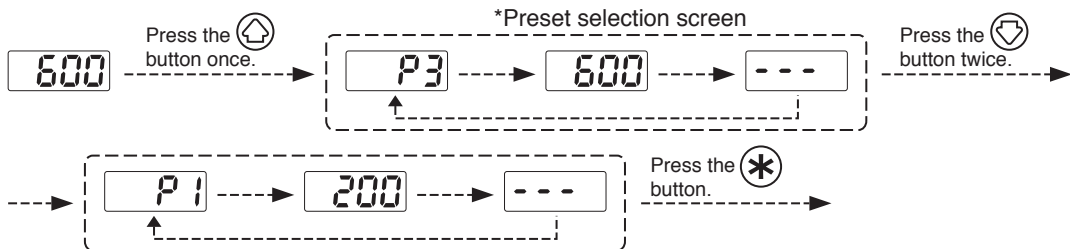

Control will begin with new preset setting.

The procedure for making changes to the preset temperatures, timer and air flow is the same as the "Setting/Changing the Temperature and Timer" and "Setting of the air flow".

## ● Restriction on setting changes (Password function)

It is possible to restrict certain setting changes to the unit.

There are three choices for the password setting.

Enter the parameter settings to change the mode. (Please refer to [6. PARAMETER SETTING].)

	0 : Open	1 : Partial	2 : Restricted
Switch to the parameter setting mode	○	×	×
Switch to the temperature setting mode	○	△	×
Switch to the preset selection mode	○	△	×
Switch to the offset setting mode	○	△	×
Make airflow adjustments	○	△	×

○ : You can make changes without entering a password.

△ : You can choose whether or not a password is needed to make changes.

×



Select and input three letters for password from six letters on the right.



The letters for password

Example: The procedure for changing the set temperature when the unit is restricted by a password. (Password is "AbC")

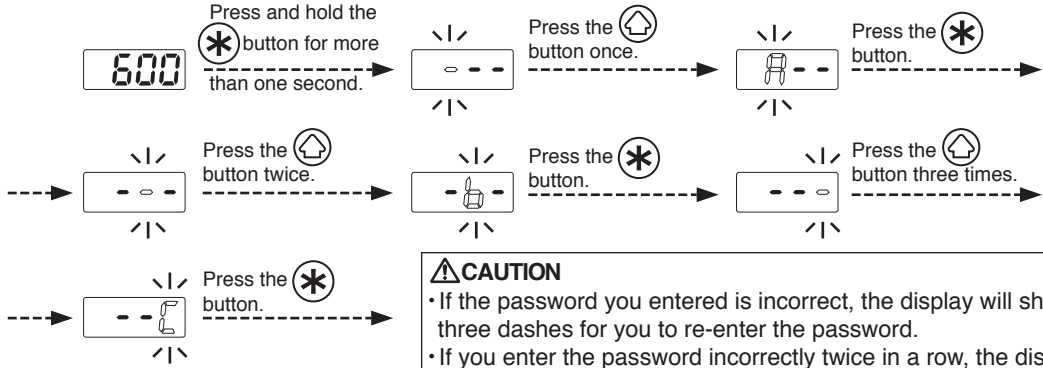

**CAUTION**

- If the password you entered is incorrect, the display will show three dashes for you to re-enter the password.
- If you enter the password incorrectly twice in a row, the display will return to the previous screen.

The unit will move to the change setting screen for each mode after entering the password. Please change the setting for each mode according to the procedure covered in this manual.

● **Offset mode {Setting is available within the range of ±90°F (50°C)}**

**CAUTION**  
If the total of a set value and an offset value exceeds 1120°F, the exceeding portion in the offset value is not effective.

Example: Changing the offset setting from 0°F to -30°F

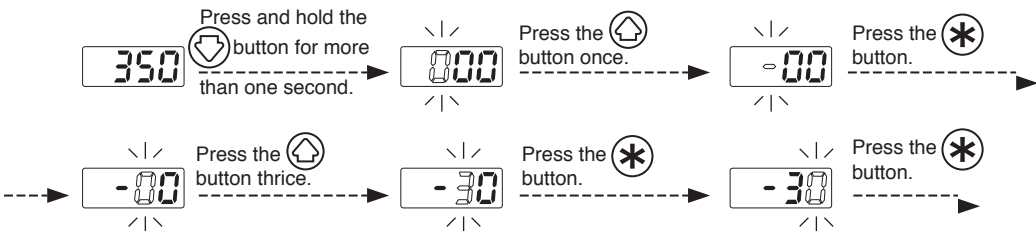

Each of the set values is displayed for two seconds, and each change is finalized.

**Other main functions**

● **Chain Presets function**

In this station, when you turn on "Preset mode" and "Chain Presets function" in the parameter settings and set the timer for each preset, available presets are called in from "P-1" to "P-5" allowing you to simulate up to a 5 step rework profile.

A preset in which "000" is set in the timer setting is skipped and the next preset is automatically started.

● **Auto sleep function**

When the handpiece is placed in the holder, the automatic sleep function starts working (by default). Pressing the START/STOP (HOT AIR) button in this state will not turn on the station. If the handpiece is placed in the holder while it is blowing hot air, start of automatic cooling is forced before the stop of operation.

**CAUTION**  
When installing this station, do not place flammable substances behind the outlet of the handpiece. If the handpiece is placed in the iron holder while blowing hot air, serious accidents such as fire may be caused by hot air.

### ● Auto shutoff function

The auto shutoff function works by default after the station is idle for 30 minutes and it automatically enters a power save state.

### ● Forced cooling bypass function



With this function enabled, if you press the "S" button (  button) again during cooling, cooling is stopped. This function is used when working temperature is low and you do not have to wait until automatic stop is made. When the set temperature is 716°F or more, the function is unavailable.

#### CAUTION

Please do not use this function at high temperatures.















### ● Check of settings

Example : When the set temperature is 650°F and the timer setting is 150 seconds.

Pressing the  button once allows you to check the settings of the set temperature  and set time  in this order.

## 6. PARAMETER SETTING

The HAKKO FR-810B has the following parameters:

Parameter name	Parameter No.	Value	Initial value
°C / °F selection	01	C/F	°F
Auto sleep ON/OFF setting	07	0: OFF / 1: ON	1
Auto shutoff ON/OFF setting	08	0: OFF / 1: ON	1
Setting mode selection	11	0: Normal / 1: Preset	0
The number of preset *		 (2 pcs) ~  (5 pcs)	
Password setting	14	0: Open / 1: Partial / 2: Restricted	0
Temperature setting mode **		 :○ /  :×	
Preset selection mode **		 :○ /  :×	
Offset setting mode **		 :○ /  :×	
Air flow mode **		 :○ /  :×	
Password***		<i>A B C D E F</i> Select three letters	-
Auto shutoff time setting	18	30~60min (Set in units of minutes)	30
Timer mode	20	o: Open Timing / c: Closed Timing	o
Forced cooling bypass	21	0: OFF / 1: ON	0
Preset connection ON/OFF setting	22	0: OFF / 1: ON	0

\* It is displayed only when "1:Preset mode" is selected in the setting mode.

\*\* It is displayed only when "1:Partial" is selected in the password setting.

\*\*\*It is displayed only when either "1:Partial" or "2:Restricted" is selected in the password setting.

---

● **01 : °C or °F temperature display selection**

The displayed temperature can be switched between Celsius and Fahrenheit.

● **07 : Auto sleep ON/OFF setting**



Select whether you will activate the auto sleep function.

● **08 : Auto shutoff ON/OFF setting**

Select whether you will activate the auto shut off function.

● **11 : Setting mode selection**

Temperature setting can be switched between the normal mode and the preset mode.

If selecting the preset mode, you will be asked for the number of preset to have available for programming. Press the  or  button to set the number.

● **14 : Password setting**

Select "Open", "Partial" or "Restricted" for password setting. If selecting the Restricted, perform the setting for password. If selecting partial, choose whether or not the password function is needed when moving to the temperature setting, preset, offset, and air flow modes and set the password.

● **18 : Auto shutoff time setting**

Set auto shutoff time. The setting is available within 30 to 60 minutes in increments of one minute.

● **20 : Timer mode selection**

Timer mode setting can be switched between the Opened timing and the Closed timing modes.





● **21 : Forced cooling bypass**

Specify whether or not to enable the function that allows you to force the termination of cooling after completion of work. Forced termination in high temperature may cause premature failure of the heating element. Do not use the function except for work in low temperature.











● **22 : Chain Preset setting**

Select whether you will activate the Chain Preset function. If you turn on "Preset mode" and "Chain Preset function", available presets are called in sequence from "P-1" to "P-5" allowing you to simulate up to a 5 step rework profile.











## ● Parameter entering mode

1. Turn off the power switch.
2. Turn on the power switch while pressing the  button.
3. When the display shows , the station is in parameter entering mode.
4. You can switch the parameter No. by pressing the  or .











### A. °C or °F temperature display selection

1. Either  or  will be displayed if you press the  button when  is displayed.
2.  and  will be switched alternately If you press the  () button.
3. The display will return to  if you press the  button after selecting.











### B. Auto sleep ON/OFF setting

1. Either  or  will be displayed if you press the  button when  is displayed.
2.  and  will be switched alternately If you press the  () button.
3. The display will return to  if you press the  button after selecting.





### C. Auto shutoff ON/OFF setting

1. Either  or  will be displayed if you press the  button when  is displayed.
2.  and  will be switched alternately If you press the  () button.
3. The display will return to  if you press the  button after selecting.



### D. Setting mode selection

1. Either  or  will be displayed if you press the  button when  is displayed.
2.  (The normal mode) and  (The preset mode) will be switched alternately, if you press the  () button.
3. The display will return to  if you press the  button after selecting.\*





\* If you select the preset mode, the display will move to the preset selection screen.

4. The number of active preset will be displayed If you press the  button at 3.  
(Example : If the number is three,  is displayed.)
5. Press the  () button to change the value and select the number of active preset you required.













**The unit will accept values from 2 through 5.**

6. The display will return to  if you press the  button after selecting.

## E. Password setting





1. Either  ,  or  will be displayed if you press the  button when  is displayed.
2. If you press the  (  ) button,  (Open),  (Partial) and  (Restricted) will be switched alternately.
3. If you press the  button after selecting, the display will return to  . \*1、 2

**\*1 The display will move to the following selection screen if you select  (Partial).**







4. If you press the  button at 3, you will be asked whether or not the password function is needed when moving to the temperature setting mode.
5. Either  (without password) or  (with password) will be displayed if you press the  (  ) button.
6. If you press the  button after selecting, you will be asked whether or not the password function is needed when moving to the preset selection mode.
7. Either  (without password) or  (with password) will be displayed if you press the  (  ) button.
8. If you press the  button after selecting, you will be asked whether or not the password function is needed when moving to the offset mode.
9. Either  (without password) or  (with password) will be displayed if you press the  (  ) button.
10. If you press the  button after selecting, you will be asked whether or not the password function is needed when moving to the Air flow mode.
11. Either  (without password) or  (with password) will be displayed if you press the  (  ) button.
12. If you press the  button after selecting, the display will move to password setting screen.

**\*2 If you select  (Restricted), the display will move to the following password setting screen.**











**If you select  (Partial), the display will move to the following the password setting screen after selecting \*1.**

11. The hundreds digits in the display will begin to flash. It indicates that you can enter the value.  
Press the  (  ) button to enter the letter you required.
12. The tens digits in the display will begin to flash if you press the  button after entering.  
Use the same procedure to enter the letters for tens and units digit.
13. The display will return to  if you press the  button after entering the units digit.











### F. Auto shutoff time setting

1. Auto shutoff time (30 minutes early) will be displayed if you press the  button when  is displayed.
2. Press the  () button, you can change to the desired value. The values you can enter is 30 to 60 (minutes).
3. The display will return to  if you press the  button after selecting.











### G. Timer mode selection









1. Either  or  will be displayed if you press the  button when  is displayed.
2.  (Open Timing) and  (Closed Timing) will be switched alternately If you press the  () button.
3. The display will return to  if you press the  button after selecting.



### H. Forced cooling bypass

1. Either  or  will be displayed if you press the  button when  is displayed.
2.  and  will be switched alternately If you press the  () button.
3. The display will return to  if you press the  button after selecting.

### I. Chain Preset setting

1. Either  or  will be displayed if you press the  button when  is displayed.
2.  and  will be switched alternately If you press the  () button.
3. The display will return to  if you press the  button after selecting.

After changing parameters, press and hold the  button down for at least two seconds until  is displayed. At this time, you can switch between  and  by pressing the  () button. Select  if you are finished making changes or  if you need to go back and make more changes. Press the  button to confirm your selection.

**Changes will not be completed until  is displayed and you press the  button.**  
**Please note that no changes will be made if you turn off the power while making changes.**

# 7. TEMPERATURE DISTRIBUTION CHART

## ⚠ CAUTION

- These charts do not define the temperature characteristics, and are for reference only.
- The temperature distribution charts for HAKKO 850 or 850B should not be used for HAKKO FR-810B. HAKKO FR-810B uses a different pump and control system. When you use the HAKKO FR-810B, make sure to refer to the temperature distribution charts shown to the under.
- The hot air temperature may not reach the set temperature depending upon the combination of the nozzle and the set air flow. In this case, reduce the set temperature or the air flow.

- Test condition: Measured at a point 1mm (0.04 in.) from the nozzle by recorder.

**HAKKO FR-810B Airflow**

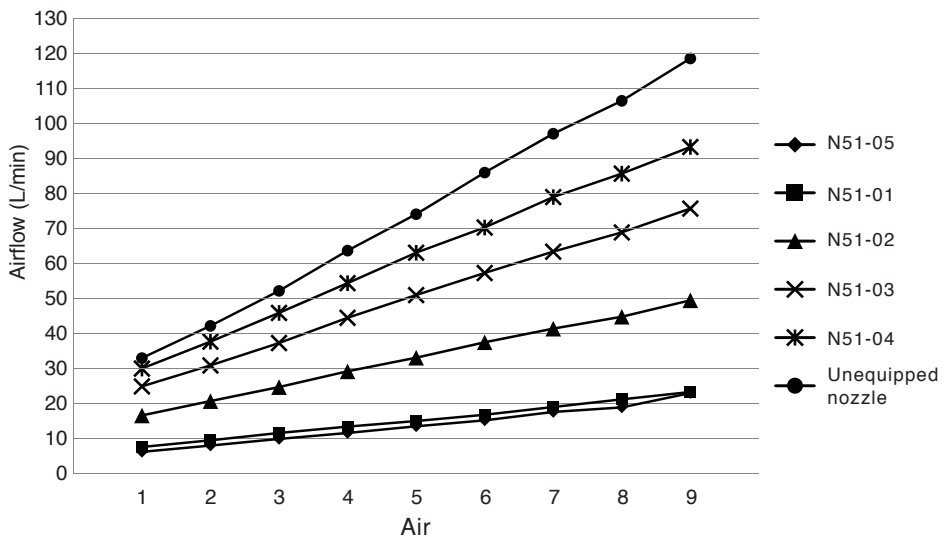

**N51-01 Single  $\phi$ 2.5 (0.10)**

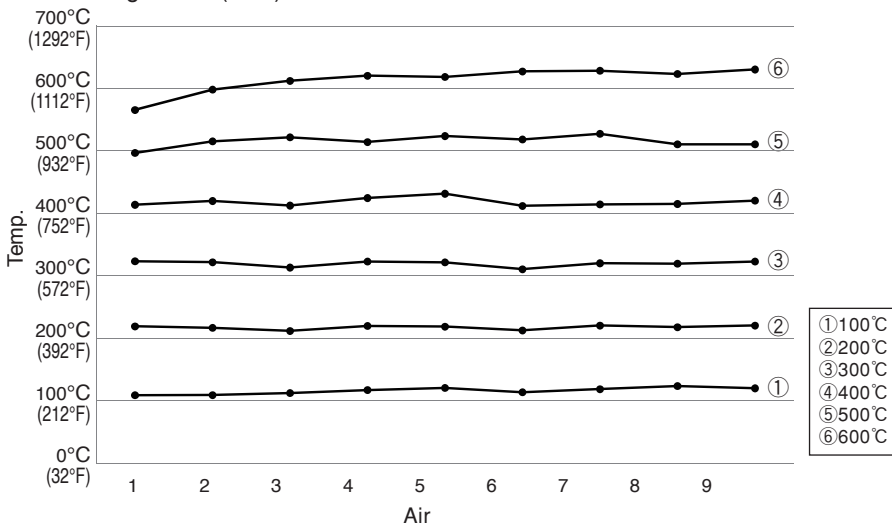

**N51-02 Single ø4.0 (0.16)**

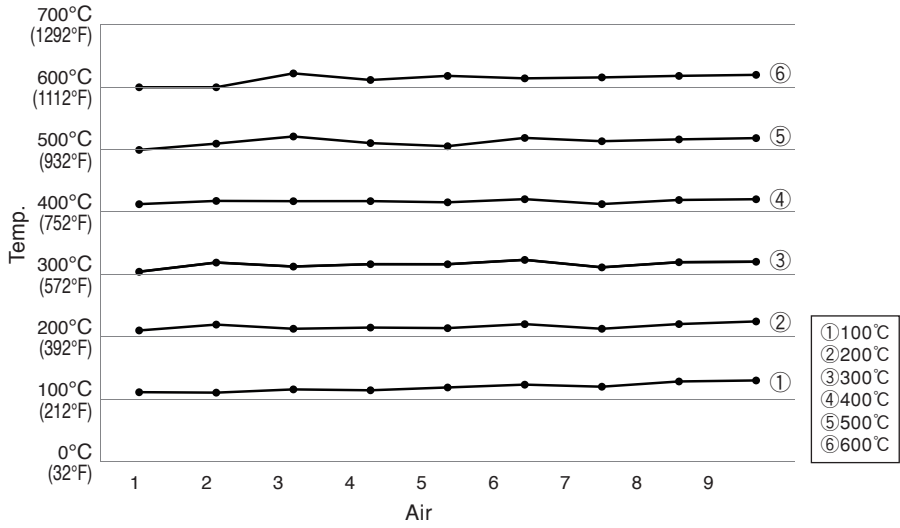

**N51-03 Single ø5.5 (0.22)**

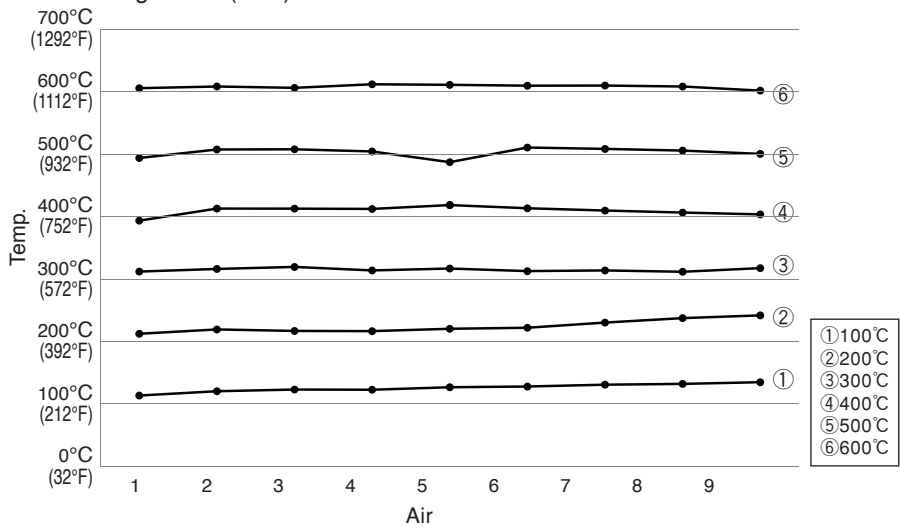



**N51-04 Single  $\phi$ 7.0 (0.28)**

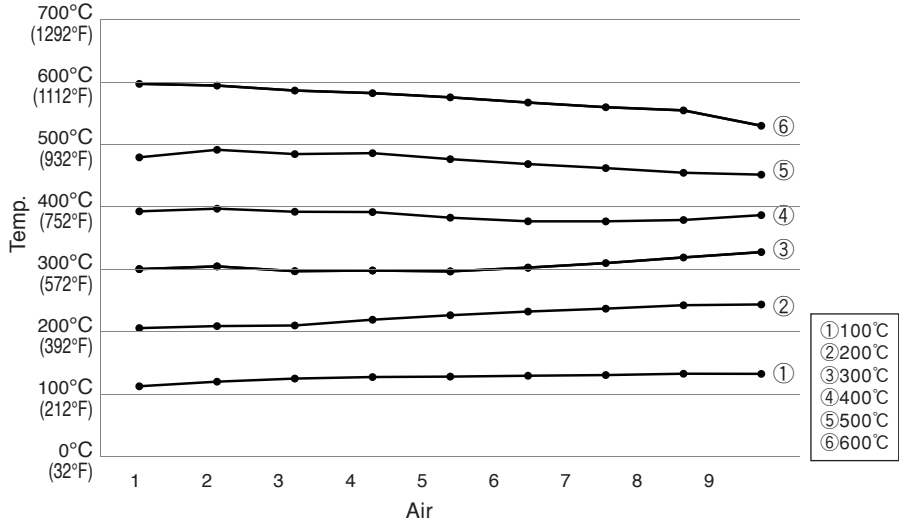

**N51-05 Bent Single 1.5 x 3 (0.06 x 0.12)**

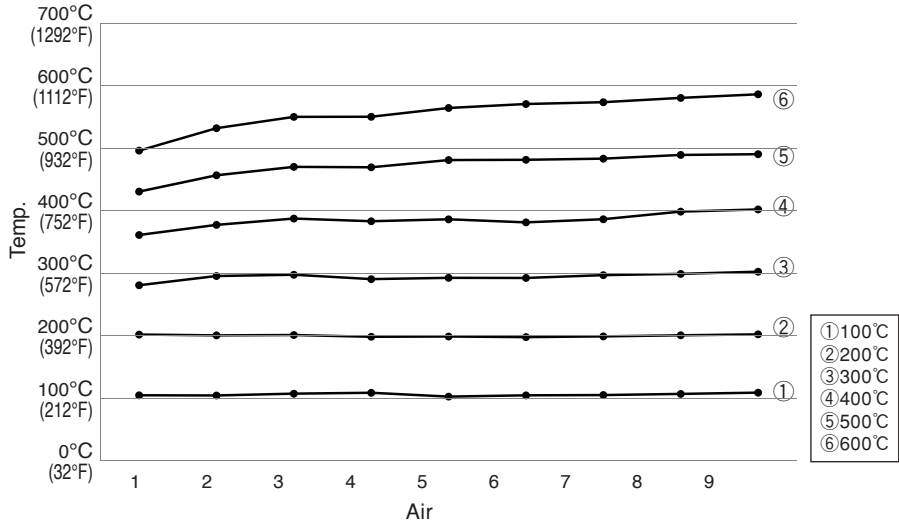

## 8. MAINTENANCE / INSPECTION

### ⚠ CAUTION

Replacing the heating element is very dangerous. Be sure to turn the power switch OFF and be careful of the following procedure when replacing the heating element.

#### A. Remove the heating element

### ⚠ CAUTION

When replacing the heater, please be careful not to apply force, such as vacuum pipe is bent.

1. Remove the 4 screws that attach the heater pipe to the handpiece. Remove the heater pipe.

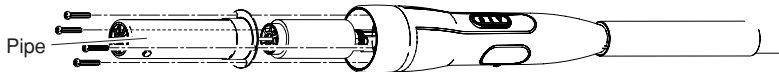

2. Remove the mica from inside the heater pipe.

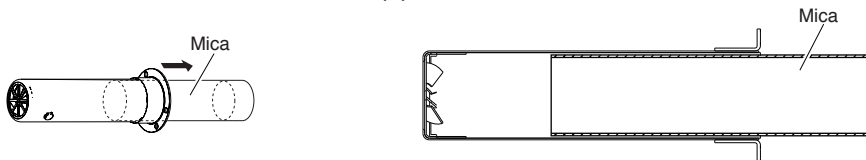

3. Disconnect and remove the heating element assembly.

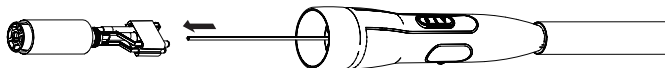

#### B. Measure the resistance value

##### ● Normal heater resistance value

Connect an ohmmeter across the connector terminals (a).

The correct values are approximately:  $14\Omega$  ( $\pm 10\%$  100-110V),  $17\Omega$  ( $\pm 10\%$  120V),  $41\Omega$  ( $\pm 10\%$  220-240V).

If the resistance value is incorrect, replace the part.

##### ● Normal sensor resistance value

Connect an ohmmeter across the connector terminals (b). If the resistance value is  $\infty$ , replace the part.

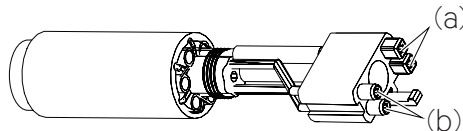

Refer to the instructions included with the replacement part.

### ⚠ CAUTION

Handle the heating element with care. Never touch the heating element wire!

## 9. ERROR MESSAGE

When the error detection software in the HAKKO FR-810B detects an error, a message is displayed to alert the operator. See “Troubleshooting” for procedures to correct the error.

### ● Sensor Error

S-E

This error occurs when there is the possibility of a sensor failure (or a failure in the sensor circuit). The **S-E** flashes and the power is shut down.

### ● Heater Error

H-E

This error occurs when the temperature of the hot air is falling even though the heater is on. The **H-E** flashes to indicate the possibility of a heater failure.

### ● Fan Error

F-E

This error occurs when there is the possibility of a fan failure. The **F-E** flashes and the power is shut down.

## 10. TROUBLE SHOOTING GUIDE

### ⚠ WARNING

Before checking the inside of the HAKKO FR-810B or replacing parts, be sure to disconnect the power plug. Failure to do so may result in electric shock.

- The unit does not operate when the power switch is turned on.

**CHECK** : Is the fuse blown?

**ACTION** : Investigate why the fuse blew and then replace the fuse. If the cause can not be determined, replace the fuse. If the fuse blows again, send the unit in for repair.

- **S-E** is displayed

**CHECK** : Is the sensor broken?

**ACTION** : Measure the resistance value of the sensor. When the resistance value is  $\infty$ , replace the heater.

- **H-E** is displayed

**CHECK** : Is the heater broken?

**ACTION** : Measure the resistance value of the heater. The correct values are approximately: 14 $\Omega$  ( $\pm 10\%$  100-110V), 17 $\Omega$  ( $\pm 10\%$  120V), 41 $\Omega$  ( $\pm 10\%$  220-240V). When the resistance value is not within the normal range, replace the heater.

- **F-E** is displayed

**ACTION** : The fan may be broken. Replace the fan with a new one.

# 11. PARTS LIST

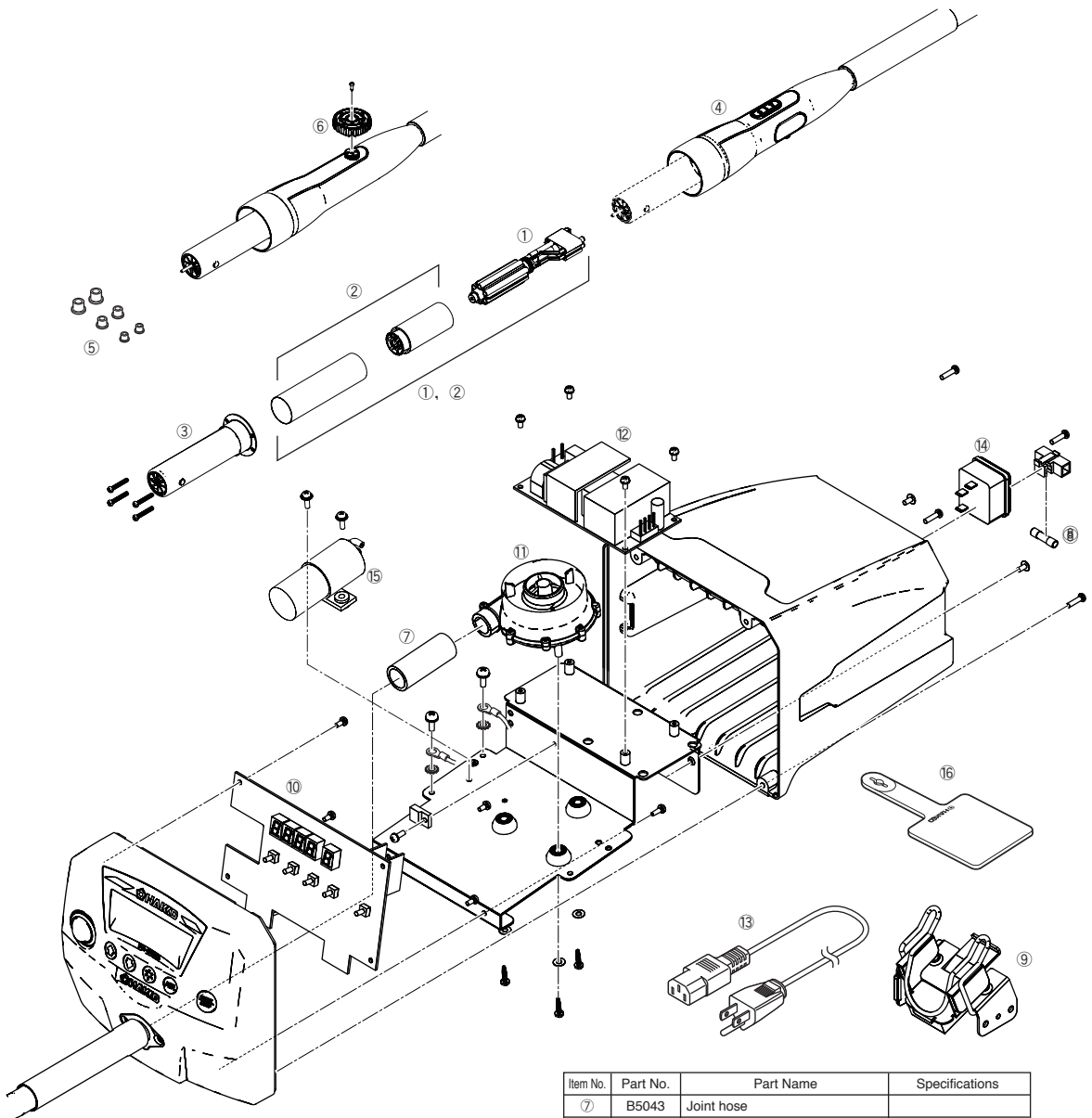

● HAKKO FR-810B

Item No.	Part No.	Part Name	Specifications
①, ②	A5005	Heating element assembly	100-110V
	A5006	Heating element assembly	120,127V
	A5007	Heating element assembly	220-240V
①	A5022	Heating element	100-110V
	A5023	Heating element	120,127V
	A5024	Heating element	220-240V
②	B5049	Mica	with heater protection sleeve
③	B5045	Pipe	
④	B5107	Handle with cord assembly	with pipe
⑤	A1520	Pad ø3 mm (0.12 in.)	Set of 5
	A1439	Pad ø5 mm (0.20 in.)	Set of 5
	A1438	Pad ø7.6 mm (0.30 in.)	Set of 5
⑥	B3023	Vacuum pipe adjustment knob (L)	With screw

Item No.	Part No.	Part Name	Specifications	
⑦	B5043	Joint hose		
⑧	B5044	Fuse/250V-10A	100-127V	
	B5060	Fuse/250V-6.3A	220-240V	
⑨	B5048	Handpiece holder		
⑩	B5108	P.W.B. / 100-127V		
	B5109	P.W.B. / 220-240V		
⑪	B5052	Fan		
⑫	B5053	Power unit		
⑬	B5054	Power cord, 3 wired cord & American plug	U.S.A.	
	B2421	Power cord, 3 wired cord but no plug		
	B2422	Power cord, 3 wired cord & BS plug	India	
	B2424	Power cord, 3 wired cord & European plug	220V KTL, 230V CE	
	B2425	Power cord, 3 wired cord & BS plug	230V CE, U.K.	
	B2426	Power cord, 3 wired cord & Australian plug		
	B2436	Power cord, 3 wired cord & Chinese plug	China	
	B3508	Power cord, 3 wired cord & American plug (B)		
	B3550	Power cord, 3 wired cord & SI plug		
	B3616	Power cord, 3 wired cord & BR plug		
	⑭	B2384	Inlet	
	⑮	B5092	Pump	
	⑯	B2300	Heat resistant pad	

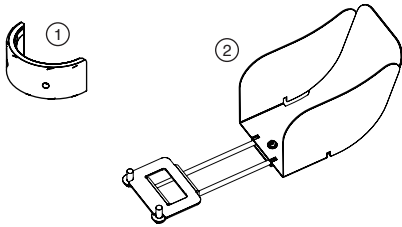

● Optimal Parts

Item No.	Part No.	Part Name	Specifications
①	B5059	Adapter/ for fixture (C1392B)	×2
②	B5126	Air guard assembly	With fixing bracket

● Assembly of the air guard

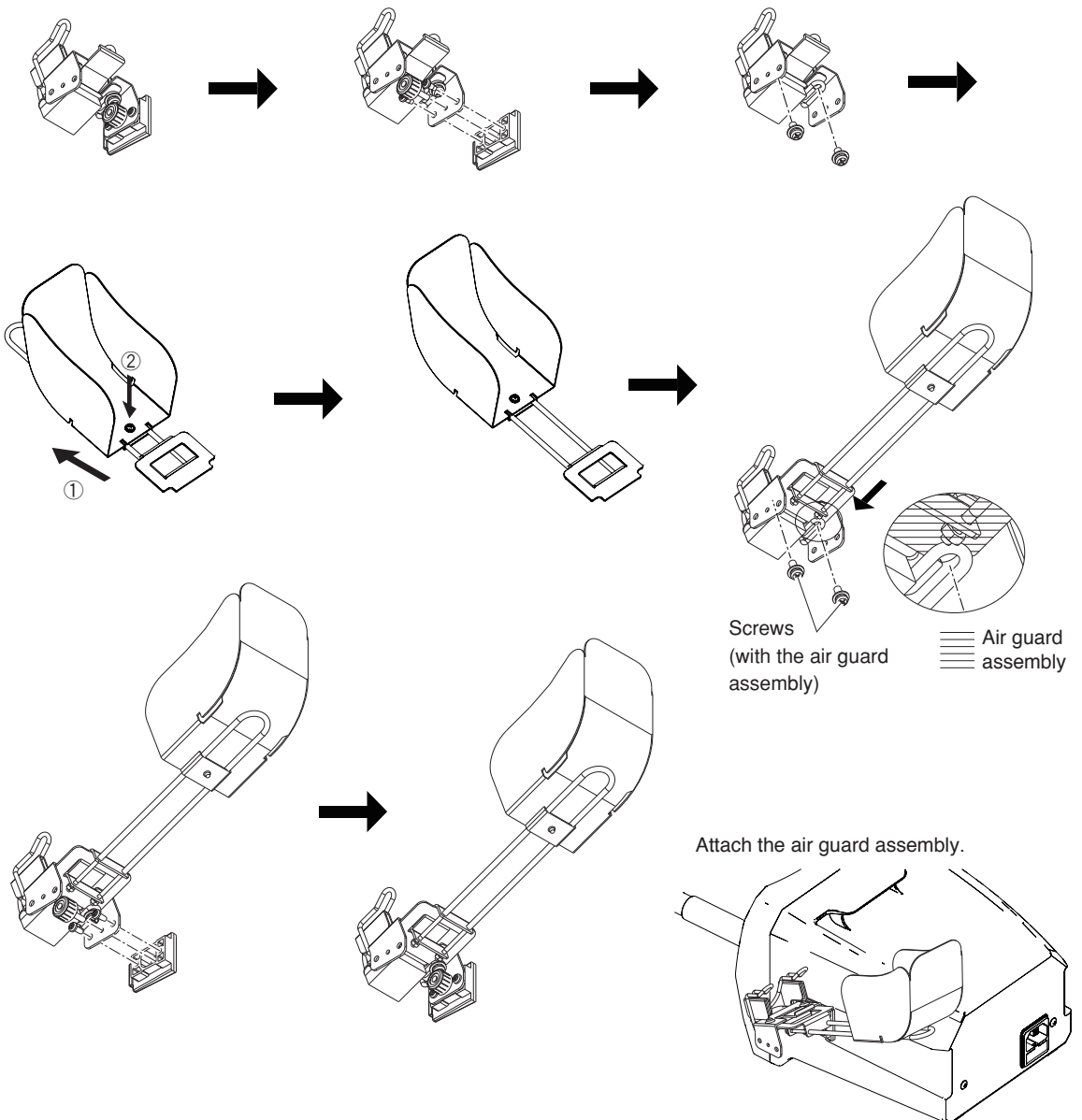

# 12. OPTIONAL PARTS (Nozzle)

## ● Straight nozzle

N51-01 Single  $\phi 2.5$  (0.1)

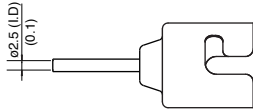

N51-02 Single  $\phi 4$  (0.16)

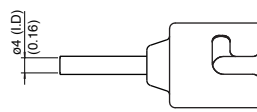

N51-03 Single  $\phi 5.5$  (0.22)

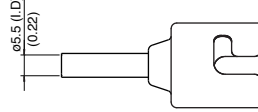

N51-04 Single  $\phi 7$  (0.28)

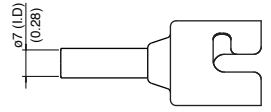

N51-05 Bent single 1.5x3 (0.06x0.12)

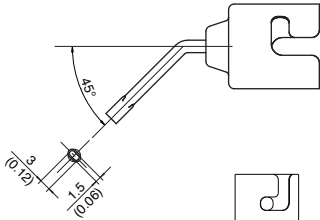

N51-06 Bent single  $\phi 5.5$  (0.22)

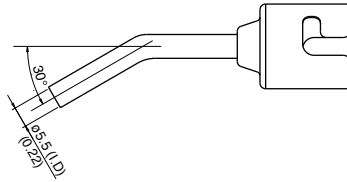

## ● BGA nozzle

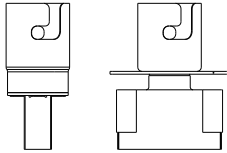

N51-10 BGA 4 x 4

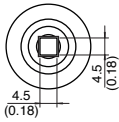

N51-11 BGA 6 x 6

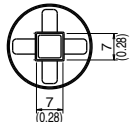

N51-12 BGA 8 x 8

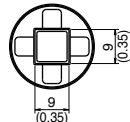

N51-13 BGA 10 x 10

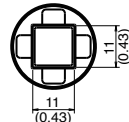

N51-14 BGA 12 x 12

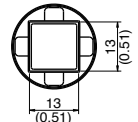

N51-15 BGA 14 x 14

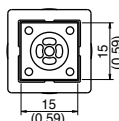

N51-16 BGA 15 x 15

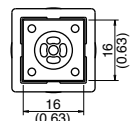

N51-17 BGA 17 x 17

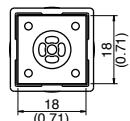

N51-18 BGA 18 x 18

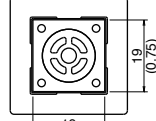

N51-19 BGA 20 x 20

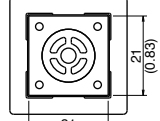

N51-20 BGA 22 x 22

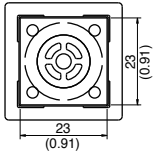

N51-21 BGA 24 x 24

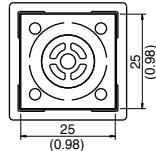

N51-22 BGA 27 x 27

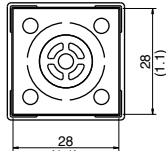

N51-23 BGA 29 x 29

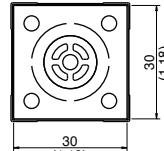

N51-24 BGA 35 x 35

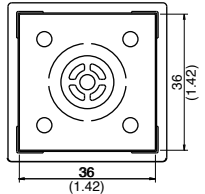

N51-25 BGA 38 x 38

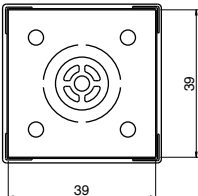

N51-26 BGA 40 x 40

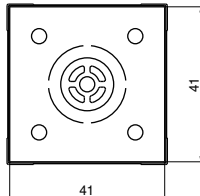

# Accessories

## ● Combining with other products

The HAKKO FR-810B can be combined with the following products for operation as a rework system. For usage details, please refer to the instruction manual for each product.

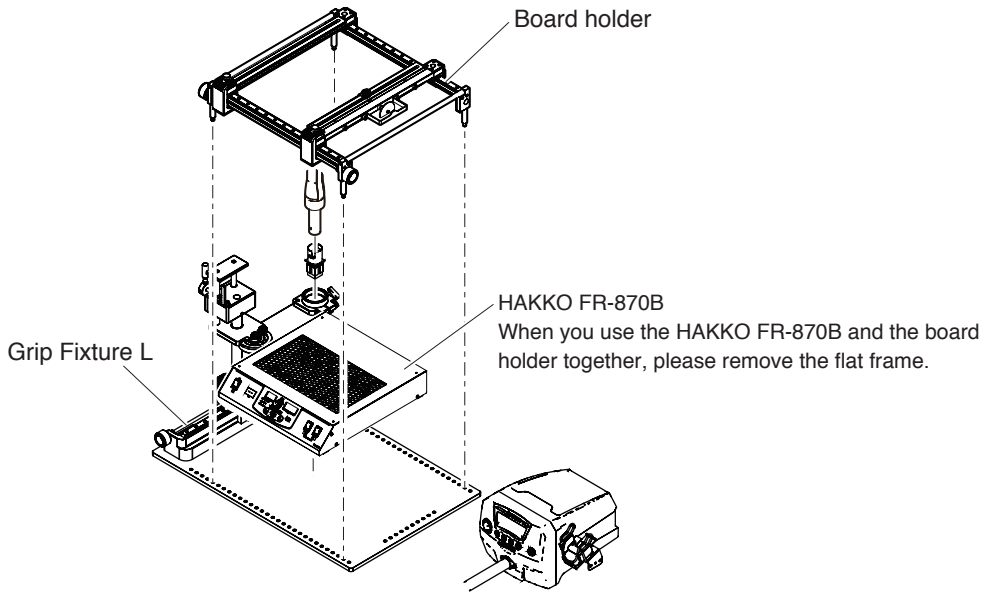

Example: Combination of HAKKO FR-810B, Grip Fixture L, Preheater (HAKKO FR-870B), and board holder.

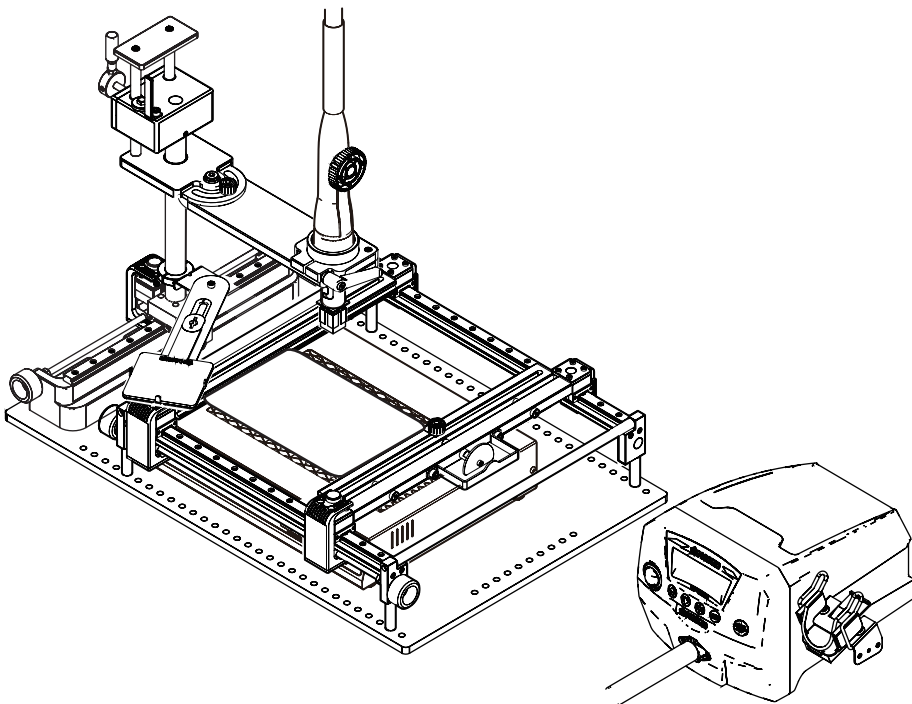

# 13. OPTIONAL PARTS (Accessories)

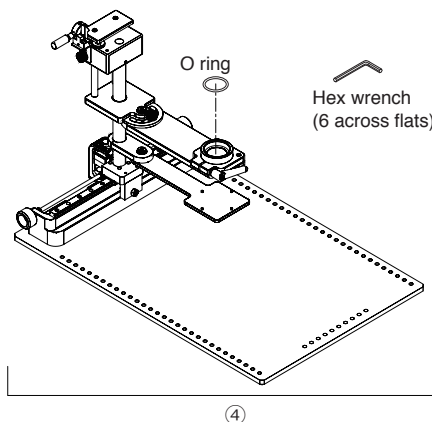
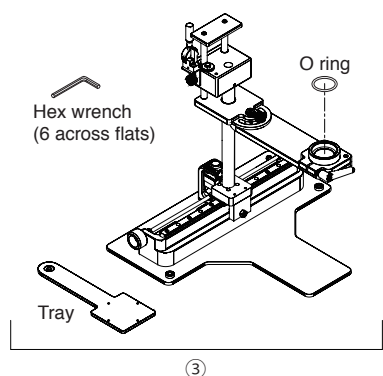
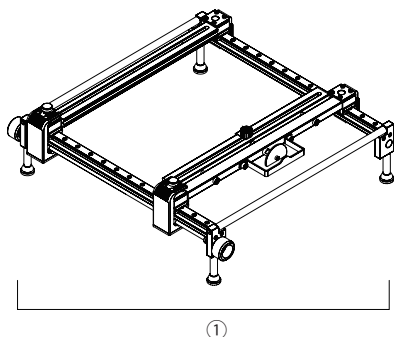

Item No.	Part No.	Part Name	Specifications
①	C5027	Board holder	
②	C5028	Grip Fixture M	
③	C5029	Grip Fixture L	



**HAKKO CORPORATION**

**HEAD OFFICE**

4-5, Shiokusa 2-chome, Naniwa-ku, Osaka 556-0024 JAPAN

TEL: +81-6-6561-3225 FAX: +81-6-6561-8466

<http://www.hakko.com> E-mail: [sales@hakko.com](mailto:sales@hakko.com)

**OVERSEAS AFFILIATES**

**U.S.A.: AMERICAN HAKKO PRODUCTS, INC.**

TEL: (661) 294-0090 FAX: (661) 294-0096

Toll Free (800)88-HAKKO

+ 2 5 5 6

<http://www.hakkousa.com>

**HONG KONG: HAKKO DEVELOPMENT CO., LTD.**

TEL: 2811-5588 FAX: 2590-0217

<http://www.hakko.com.hk>

E-mail: [info@hakko.com.hk](mailto:info@hakko.com.hk)

**SINGAPORE: HAKKO PRODUCTS PTE LTD.**

TEL: 6748-2277 FAX: 6744-0033

<http://www.hakko.com.sg>

E-mail: [sales@hakko.com.sg](mailto:sales@hakko.com.sg)

Please access to the following address for the other Sales affiliates.

<http://www.hakko.com>