

## Absolute maximum ratings

( $T_a=25^\circ\text{C}$ )

Symbol	Ratings	Unit
$V_{CB0}$	120	V
$V_{CEO}$	100	V
$V_{EBO}$	6	V
$I_c$	3	A
$I_{cP}$	5 (PW $\leq$ 1ms, Du $\leq$ 50%)	A
$I_B$	0.2	A
$P_T$	4 ( $T_a=25^\circ\text{C}$ )	W
	20 ( $T_c=25^\circ\text{C}$ )	
$T_j$	150	$^\circ\text{C}$
$T_{stg}$	-40 to +150	$^\circ\text{C}$

## Electrical characteristics

( $T_a=25^\circ\text{C}$ )

Symbol	Specification			Unit	Conditions
	min	typ	max		
$I_{cB0}$			10	$\mu\text{A}$	$V_{CB}=120\text{V}$
$I_{EBO}$			10	mA	$V_{EB}=6\text{V}$
$V_{CEO}$	100			V	$I_c=25\text{mA}$
$h_{FE}$	2000	6000	15000		$V_{CE}=4\text{V}$ , $I_c=1.5\text{A}$
$V_{CE(sat)}$		1.1	1.5	V	$I_c=1.5\text{A}$ , $I_B=3\text{mA}$
$V_{BE(sat)}$		1.7	2.0	V	
$t_{on}$		0.5		$\mu\text{s}$	$V_{CC}\approx 30\text{V}$
$t_{stg}$		2.2		$\mu\text{s}$	$I_c=1.5\text{A}$
$t_f$		0.9		$\mu\text{s}$	$I_{B1}=-I_{B2}=3\text{mA}$
$f_T$		40		MHz	$V_{CE}=12\text{V}$ , $I_E=-0.5\text{A}$
$C_{ob}$		30		pF	$V_{CB}=10\text{V}$ , $f=1\text{MHz}$

## Equivalent circuit diagram

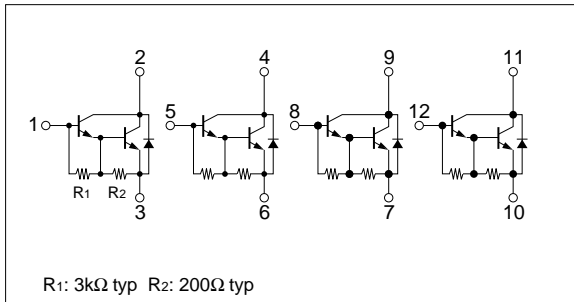

## Characteristic curves

$I_c$ - $V_{CE}$  Characteristics (Typical)

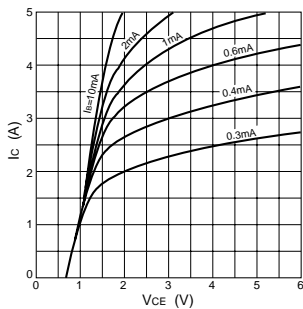

$h_{FE}$ - $I_c$  Characteristics (Typical)

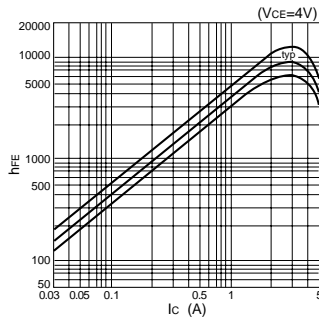

$h_{FE}$ - $I_c$  Temperature Characteristics (Typical)

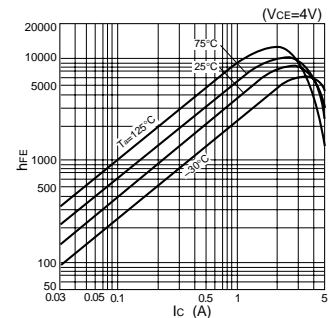

$V_{CE(sat)}$ - $I_c$  Temperature Characteristics (Typical)

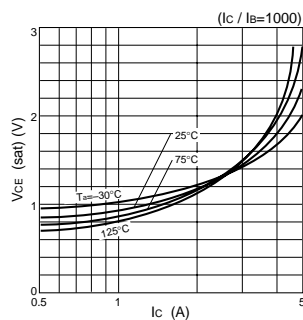

$V_{CE(sat)}$ - $I_B$  Characteristics (Typical)

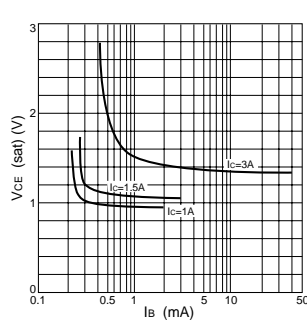

$I_c$ - $V_{BE}$  Temperature Characteristics (Typical)

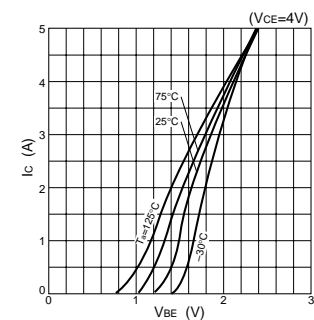

$\theta_{j-a}$ -PW Characteristics

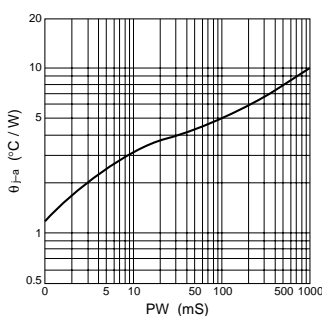

$P_T$ - $T_a$  Characteristics

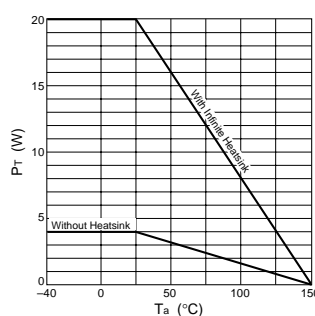

Safe Operating Area (SOA)

