

ISL9238EVAL1Z Evaluation Board User Guide

Description

The [ISL9238](#) is a buck-boost Narrow Output Voltage DC (NVDC) charger utilizing Intersil's advanced R3™ Technology to provide high light-load efficiency, fast transient response and seamless DCM/CCM transitions for a variety of mobile and industrial applications.

In Charge mode, the ISL9238 takes input power from a wide range (4V to 20V) of DC power sources (conventional AC/DC charger adapters, USB PD ports, travel adapters, etc.) and safely charges battery packs with up to 4 cells in a series configuration.

The ISL9238 supports On-the-Go (OTG) function for 2- and 4-cell battery applications. When OTG function is enabled, the ISL9238 operates in the Reverse Buck mode to provide 5V at the USB port.

The ISL9238 has serial communication via SMBus/I²C that allows programming of many critical parameters to deliver a customized solution. These programming parameters include, but are not limited to: adapter current limit, charger current limit, system voltage setting and trickle charging current limit.

The ISL9238EVAL1Z evaluation board is designed to demonstrate the performance of the ISL9238. The default value numbers of the battery in series, the switching frequency and the adapter current limit charging function can be programmed by the resistor from the PROG pin to GND. Those values also can be set by SMBus.

References

- [ISL9238](#) datasheet

Key Features

- Buck-boost NVDC charger for 1-, 2-, 3-, 4-cell Li-ion batteries
- End of Charge (EOC) option
- System power monitor PSYS output, IMVP-8 compliant
- PROCHOT# open-drain output, IMVP-8 compliant
- Allows trickle charging of depleted battery
- Optional ASGATE FET control
- Ideal diode control in Turbo mode
- Reverse buck, boost and buck-boost operation from battery
- Two-level adapter current limit available
- Battery Ship mode option
- SMBus and auto-increment I²C compatible

Specifications

- V_{IN} = 3.8V to 24V (no dead zone)
- V_{OUT} = 2.5V to 12.6V
- MAX I_{charge} up to 6A
- f_{SW} = 1MHz maximum

Ordering Information

PART NUMBER	DESCRIPTION
ISL9238EVAL1Z	ISL9238 buck-boost charger evaluation board

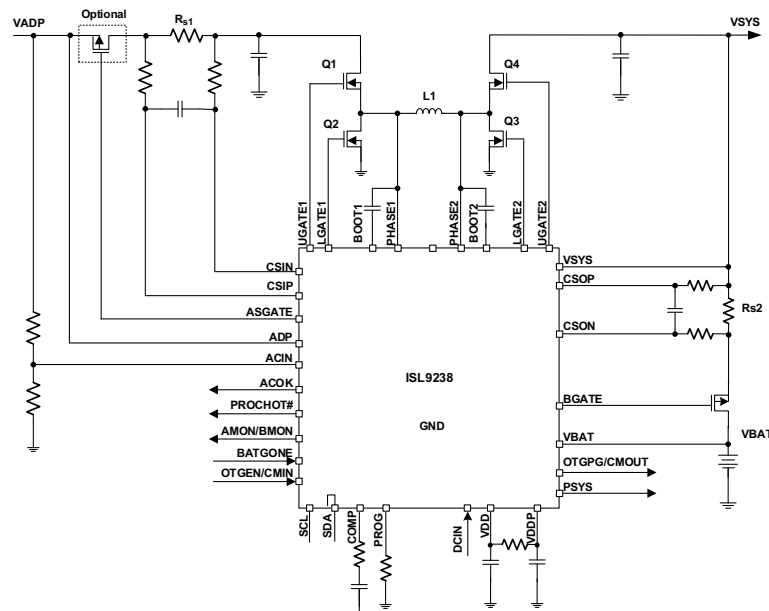

FIGURE 1. BLOCK DIAGRAM

Recommended Equipment

- 0V to 25V power supply with at least 6A source current capability
- Electronic load capable of sinking current up to 6A
- Battery emulator capable of sinking and sourcing current up to 6A
- Digital Multimeters (DMMs)
- 100MHz quad-trace oscilloscope

NOTE: Customers can use a power supply (which can source but cannot sink current) in parallel with an e-load Constant Current (CC) mode to emulate the battery. For example, for charging, set the charging current command lower than the CC mode e-load. If the e-load CC mode current is set at 3A, the charge current command is 2A, then the e-load will take 2A from the charger and take another 1A from the power supply in parallel with it. For discharging, the power supply is just like the battery to discharge current. The customer can also use the e-load Constant Voltage (CV) mode to emulate the battery to take the charging current from the charger and set the e-load CV voltage below the MaxSysV register setting, however, this e-load CV mode cannot source current like a battery.

Functional Description

The ISL9238EVAL1Z provides all circuits that are required to evaluate the features of the ISL9238. A majority of the features of the ISL9238, such as adjustable output voltage, On-the-Go (OTG) mode, Trickle Charging mode for depleted battery, and system power monitor at buck, Boost and Buck-Boost modes are available on this evaluation board.

Quick Start Guide

The number of battery cell and adapter current limit default values can be configured with a standard 1% 0603 resistor (R_{23}) from the PROG pin to GND. The "PROG PIN PROGRAMMING OPTIONS" table in the [ISL9238](#) datasheet shows the programming options. After the default number of cells in series are set, the default values for MaxSystemVoltage and MinSystemVoltage are set accordingly. These values can also be changed through the SMBus control registers, which are implemented with the Intersil GUI, shown in [Figure 2 on page 3](#).

Three LEDs are indicating ACOK, PROCHOT and OTGPG/CMOUT status, respectively. For more details about the functions of these three pins, refer to the [ISL9238](#) datasheet. Follow these steps to evaluate the ISL9238 key functions, including system voltage regulation, input current limit regulation, Charging mode, trickle Charging mode and OTG mode. [Figure 3](#), which is the top view of the evaluation board, highlights the key testing points and connection terminals. For other modes or more information about ISL9238, please refer to the [ISL9238](#) datasheet.

System Voltage Regulation

1. Set the power supply to 5V and, with the output disabled, connect the (+) to J1 and the (-) end to J2.
2. Ensure jumpers JP3, JP4 and JP6 are shorted. SW1 and SW2 should switch to the low position.
3. Turn on the power supply, measure VSYS using the DMM across (+) and (-) TP5. VSYS should read 8.38V. The current meter on the supply should read <100mA. Increase V_{IN} from 5V to 15V slowly. Monitor PH1 and PH2 to observe seamless switching from Boost mode to Buck-Boost mode and finally into Buck mode.

Input Current Limit Regulation

1. Keep V_{IN} as a constant value between 3.8V and 24V. Set the battery emulator voltage to 7.8V, connect the battery emulator output to battery leads, J5 and J6. Then, turn on the battery emulator; there is no charge and discharge current for the battery, which is consistent to the BGATE signal of a high voltage level.
2. Add an electrical load on VSYS and GND terminals, J3 and J4. Turn on the load and increase the electrical load slowly; the input current increases correspondingly and VSYS keeps stable at 8.38V. The output voltage (VSYS) will start dropping as the input current reaches the 1.5A input current limit. For the input current limit details, refer to the [ISL9238](#) datasheet. If the VSYS voltage is 150mV lower than the battery voltage, BGATE FET will turn on at a low voltage level such that the battery supplies the current to the load.

User Guide 074

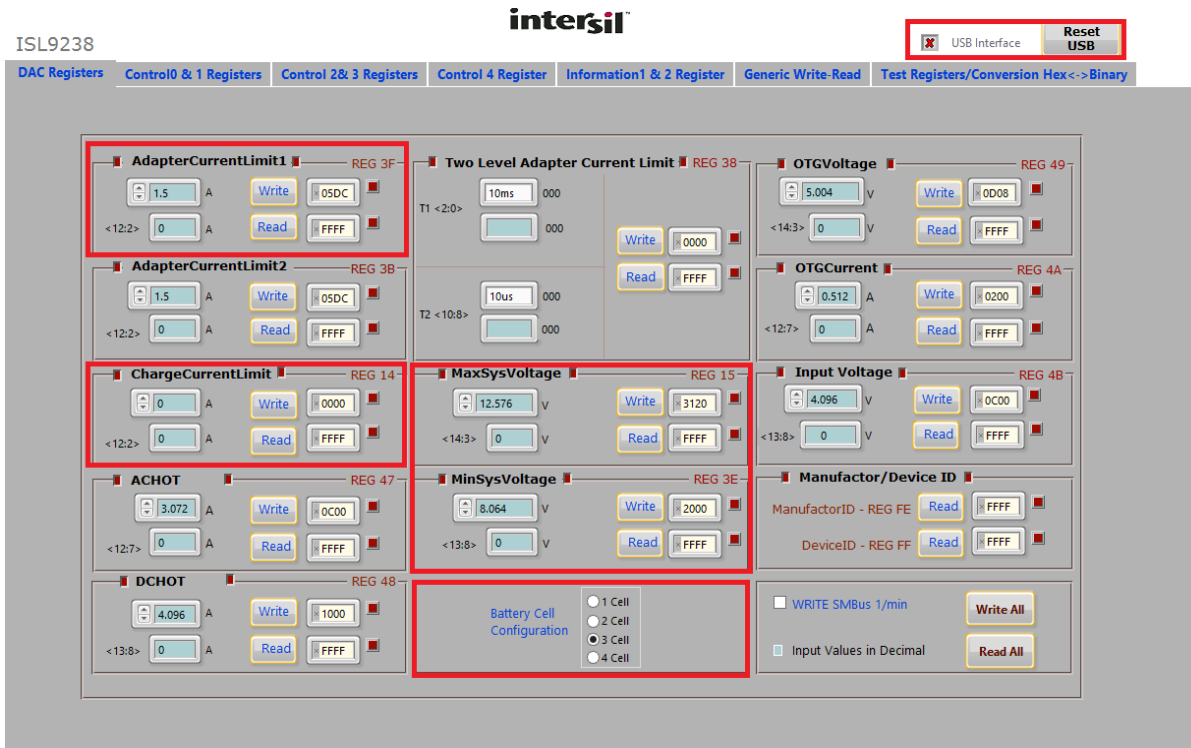

FIGURE 2. GUI SNAPSHOT

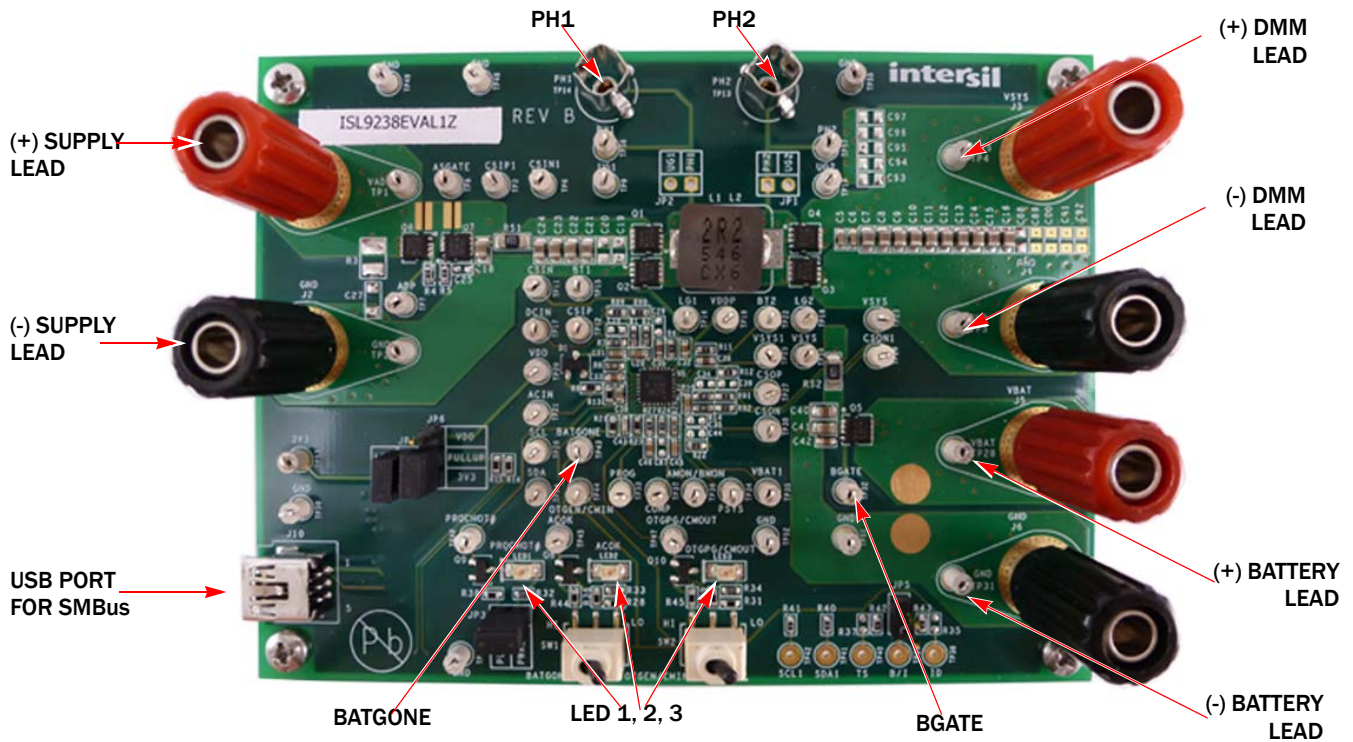

FIGURE 3. EVALUATION BOARD CONNECTION GUIDELINE

Charging Mode

1. Set the power supply to a constant value between 3.8V and 24V, then do Steps 1 and 2 in [“System Voltage Regulation” on page 2](#). Make sure the input current does not hit the limit.
2. Set the battery emulator voltage to 7.8V; connect the battery emulator output to battery leads, J5 and J6.
3. Connect the USB cable at USB port for the SMBus; LED 1, 2 and 3 are all lighting.
4. Turn on the power supply; LED 3 goes out. Then turn on the battery emulator and open Intersil ISL9238 GUI ([Figure 2 on page 3](#)). Note: The USB interface with a green tick means the GUI is ready to communicate with the evaluation board. If the USB interface shows a red cross, the GUI is not ready to communicate with the evaluation board. Click the “reset USB” button until a green tick shows in the USB interface. If not green, check the USB connection.
5. Select “2 Cell” and click the “Write All” button, all controller register values are set to the default values correspondingly. The system voltage is 8.4V, which is the value of MaxSystemVoltage in the GUI. There is no charge and discharge current for battery. Change the “ChargeCurrentLimit” from 0A to 2A then click the “Write” button. The battery is now in a 2A current charge operation. The charge current value can be monitored in the GUI by clicking the “Read” button in the ChargeCurrentLimit column. Monitor the BGATE signal status to confirm battery is in Charging mode.

Note: Make sure the input current does not reach the input current limit value, especially for a small V_{IN} input.

Trickle Charging Mode

1. Do steps 1 through 5 in [“Charging Mode”](#) without any changes.
2. Decrease the battery emulator voltage and monitor the battery charging current. As long as the battery emulator voltage is less than 5.2V (lower than SystemMinVoltage), the battery enters trickle Charging mode and the charge current decreases to 0.26A. The trickle charge current value can be changed through the SMBus control registers, refer to the [ISL9238](#) datasheet.

Note: Make sure the input current does not reach the input current limit value, especially for small V_{IN} input.

OTG Mode

1. Set the battery emulator voltage at a constant value between 5.8V and 15V; connect the battery leads, J5 and J6, with the output disabled.
2. Connect electric load on supply leads, J1 and J2, with the output disabled.
3. Connect the USB cable at the USB port for SMBus; only LED 1 light is on. Turn on the battery emulator and electrical load without adding any load.
4. Open the Intersil ISL9238 GUI. The OTGVoltage is the voltage value for load side, as shown in [Figure 4 on page 5](#), and the OTGCurrent is the OTG output current limit at load side. These values can be set as needed by the customer, within the output limit range. For their value range, please refer to the [ISL9238](#) datasheet.
5. Select the “Control0&1 registers” tab, enable the OTG function at Control1 register, then click the “Write” button, as shown in [Figure 5 on page 5](#).
6. Switch SW2 on the evaluation board to the HI position; the load voltage is regulated as an OTGVoltage value, set in [Figure 5](#), and the LED 3 light is on, which means the OTG function is enabled.
7. Increase the electrical load slowly and monitor the load voltage. As long as the load current is less than the OTGCurrent limit value, the load voltage will be regulated at the setting value.

User Guide 074

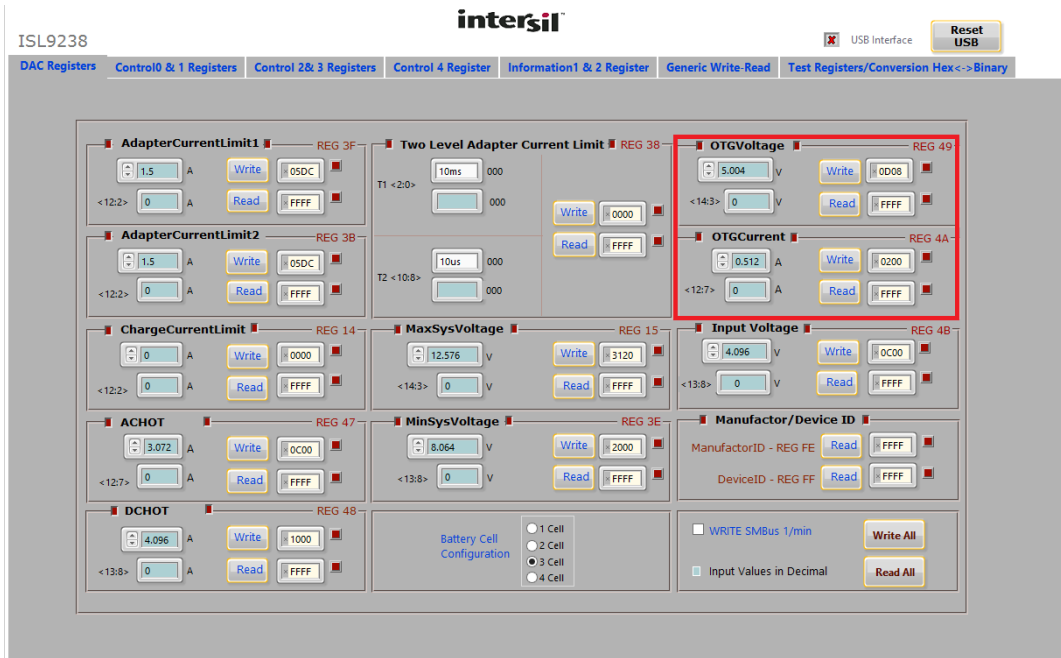

FIGURE 4. OTG VOLTAGE AND CURRENT SETTING IN GUI

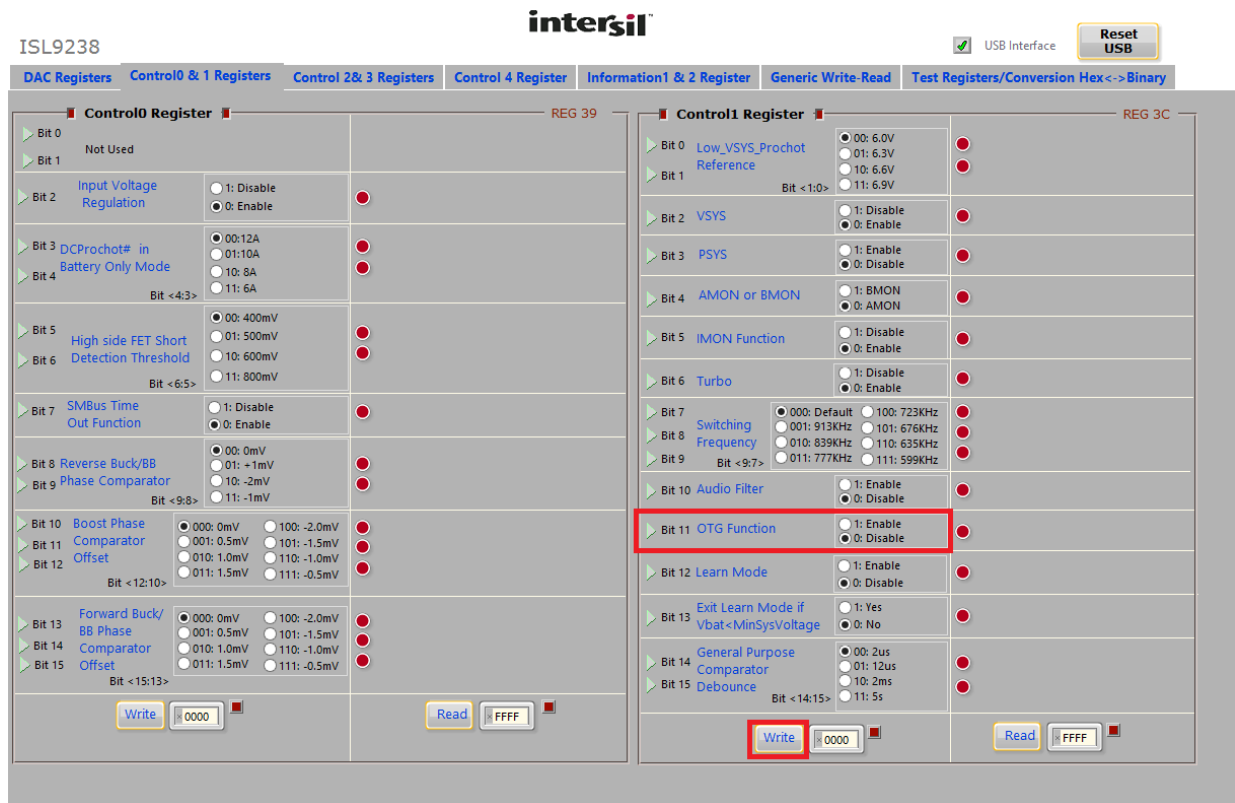
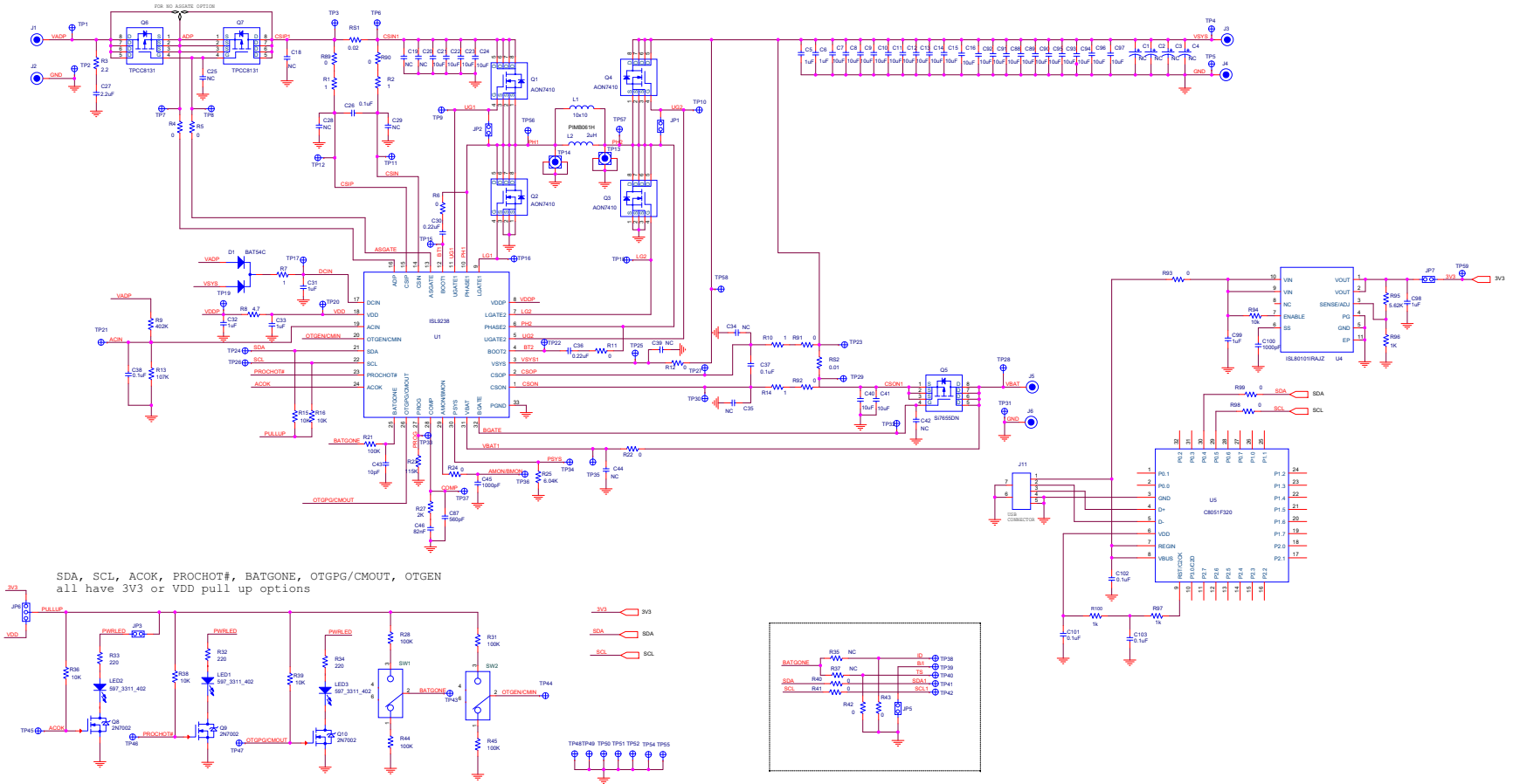

FIGURE 5. OTG FUNCTION ENABLE

ISL9238EVAL1Z Schematic

All NFETs and PFETs are 3x3 size



SDA, SCL, ACOK, PROCHOT#, BATGONE, OTGPG/CMOUT, OTGEN all have 3V3 or VDD pull up options

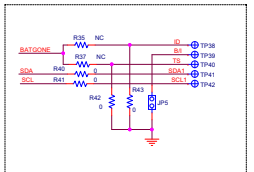

For battery connector connection

FIGURE 6. ISL9238EVAL1Z BOARD SCHEMATIC

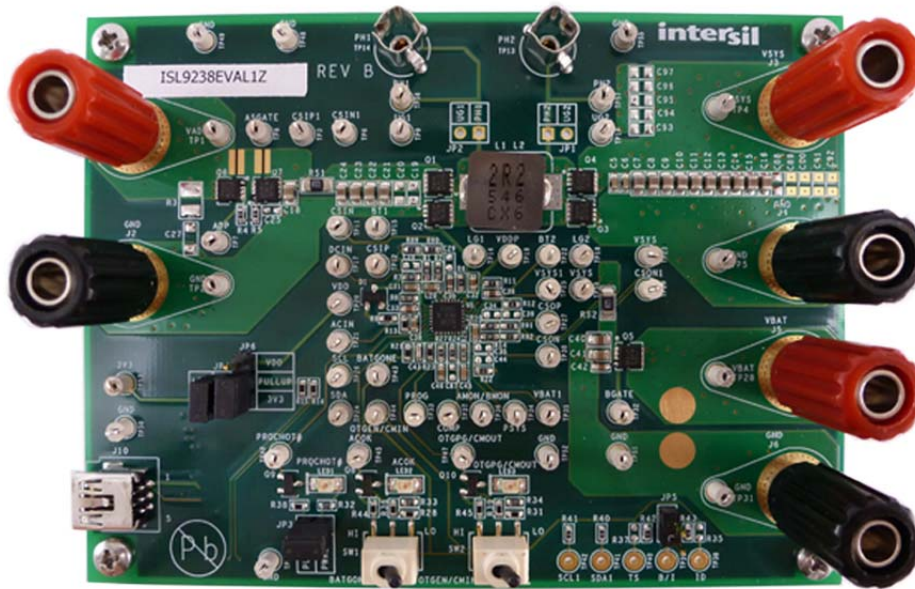

FIGURE 7. TOP OF BOARD

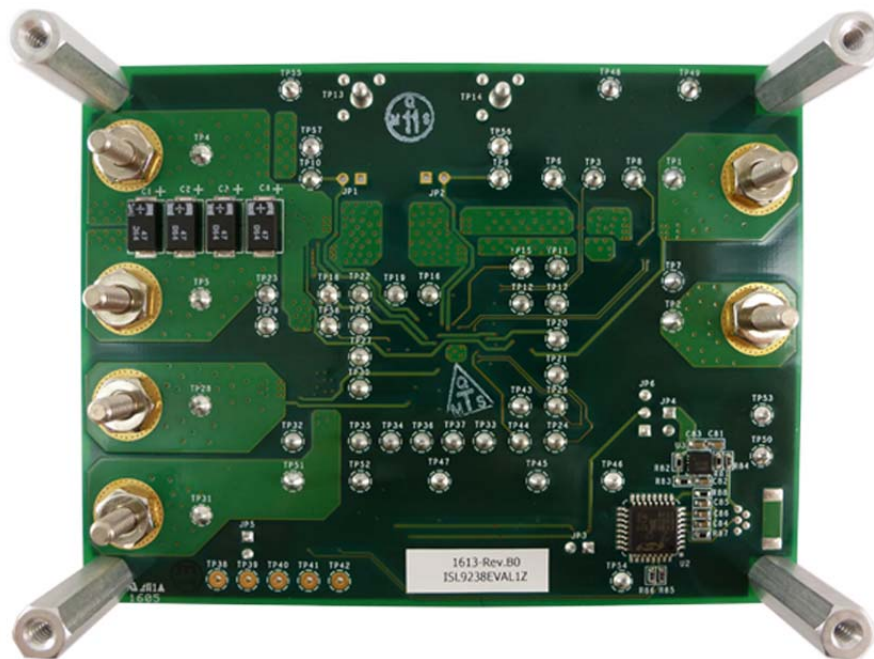

FIGURE 8. BOTTOM OF BOARD

User Guide 074

Bill of Materials

MANUFACTURER PART	QTY	UNITS	REFERENCE DESIGNATOR	DESCRIPTION	MANUFACTURER
ISL9237EVAL1ZREVBPCB	1	ea.	SEE LABEL-RENAME BOARD	PWB-PCB, ISL9237EVAL1Z, REVB, ROHS	IMAGINEERING INC
20TQC47MYF	4	ea.	C1, C2, C3, C4	CAP-POSCAP, SMD, 7.3x4.3x1.9, 47µF, 20V, 20%, 55mΩ, ROHS	SANYO
C0603COG500-100KDE	1	ea.	C43	CAP, SMD, 0603, 10pF, 50V, 10%, NPO, ROHS	VENKEL
C0603X7R160102KNE	2	ea.	C45, C82	CAP, SMD, 0603, 1000pF, 16V, 10%, X7R, ROHS	VENKEL
GRM188R71E104KA01D	4	ea.	C38, C84, C85, C86	CAP, SMD, 0603, 0.1µF, 25V, 10%, X7R, ROHS	MURATA
GRM188R61E105KA12D	9	ea.	C5, C6, C28, C29, C31, C34, C35, C81, C83	CAP, SMD, 0603, 1µF, 25V, 10%, X5R, ROHS	MURATA
GRM188R71E223KA01J	1	ea.	C46	CAP, SMD, 0603, 0.022µF, 25V, 10%, X7R, ROHS	MURATA
C1608X7R1E224K	2	ea.	C30, C36	CAP, SMD, 0603, 0.22µF, 25V, 10%, X7R, ROHS	TDK
C0603X7R160-472KNE	1	ea.	C42	CAP, SMD, 0603, 4700pF, 16V, 10%, X7R, ROHS	VENKEL
CR0603-16W-4701FT	4	ea.	C26, C32, C33, C37	CAP, SMD, 0603, 4.7µF, 10V, 10%, X5R, ROHS	VENKEL
	0	ea.	C87	CAP, SMD, 0603, DNP-PLACE HOLDER, ROHS	
C2012X5R1E106K	17	ea.	C7-C16, C18, C21, C22, C23, C24, C40, C41	CAP, SMD, 0805, 10µF, 25V, 10%, X5R, ROHS	TDK
PIMB063T-2R2MS-01	1	ea.	L1	PWR CHOKE COIL, SMD, 6.95x6.6, 2.2µH, 10A, 20%, ROHS	CYNTEC CO., LTD.
111-0702-001	3	ea.	J1, J3, J5	CONN-GEN, BIND.POST, INSUL-RED, THMBNUT-GND	JOHNSON COMPONENTS
111-0703-001	3	ea.	J2, J4, J6	CONN-GEN, BIND.POST, INSUL-BLK, THMBNUT-GND	JOHNSON COMPONENTS
131-4353-00	2	ea.	TP13, TP14	CONN-SCOPE PROBE TEST PT, COMPACT, PCB MNT, ROHS	TEKTRONIX
5002	51	ea.	TP1-TP12, TP15-TP37, TP43-TP58.	CONN-MINI TEST POINT, VERTICAL, WHITE, ROHS	KEYSTONE
54819-0519	1	ea.	J10	CONN-USB MINI-B RECEPTACLE, TH, 5 CIRCUIT, R/A, ROHS	MOLEX
68000-236HLF	1	ea.	JP6	CONN-HEADER, 1x3, BREAKAWY 1x36, 2.54mm, ROHS	BERG/FCI
69190-202HLF	3	ea.	JP3, JP4, JP5	CONN-HEADER, 1x2, RETENTIVE, 2.54mm, 0.230x0.120, ROHS	BERG/FCI
SPC02SYAN	3	ea.	JP3, JP4, JP6-Pins 1-2.	CONN-JUMPER, SHORTING, 2PIN, BLACK, GOLD, ROHS	SULLINS
BAT54C-7-F-T	1	ea.	D1	DIODE-RECTIFIER, SMD, SOT23, 30V, 200mA, DUAL DIODE, ROHS	
597-3311-407NF	3	ea.	LED1, LED2, LED3	LED, SMD, 1206, GREEN, 75mW, 3mcd, 567nm, ROHS	DIALIGHT
C8051F320-GQ	1	ea.	U2	IC-USB MICROCONTROLLER, 32P, LQFP, PROGRAMMED, ROHS	SILICON LABORATORIES
ISL80101IRAJZ	1	ea.	U3	IC-ADJ.V, 1A LDO REGULATOR, 10P, DFN, 3x3, ROHS	INTERSIL

User Guide 074

Bill of Materials

MANUFACTURER PART	QTY	UNITS	REFERENCE DESIGNATOR	DESCRIPTION	MANUFACTURER
ISL9238HRTZ	1	ea.	U1	IC-NOTEBOOK BATTERY CHARGER, 32P, QFN, 4x4, ROHS	INTERSIL
2N7002-7-F	3	ea.	Q8, Q9, Q10	TRANSISTOR, N-CHANNEL, 3LD, SOT-23, 60V, 115mA, ROHS	DIODES, INC.
SI7625DN-T1-GE3	3	ea.	Q5, Q6, Q7 (ALT: SISS27DN-T1-GE3-T)	TRANSISTOR-MOS, P-CHANNEL, -30V, -35A, 8P, PWRPAK, ROHS	VISHAY
SISA14DN-T1-GE3	4	ea.	Q1, Q2, Q3, Q4	TRANSISTOR-MOS, N-CHANNEL, 8P, PWRPAK, 30V, 20A, ROHS	VISHAY
9C06031A2R00FGHFT	5	ea.	R1, R2, R7, R10, R14	RES, SMD, 0603, 2Ω, 1/10W, 1%, TF, ROHS	YAGEO
CR0603-10W-4R70FT	1	ea.	R8	RES, SMD, 0603, 4.7Ω, 1/10W, 1%, TF, ROHS	VENKEL
CR0603-10W-000T	17	ea.	R4, R5, R6, R11, R12, R24, R40, R41, R42, R43, R84, R85, R86, R89, R90, R91, R92	RES, SMD, 0603, 0Ω, 1/10W, TF, ROHS	VENKEL
ERJ-3EKF1001V	4	ea.	R22, R83, R87, R88	RES, SMD, 0603, 1k, 1/10W, 1%, TF, ROHS	PANASONIC
CR0603-10W-1002FT	6	ea.	R15, R16, R36, R38, R39, R81	RES, SMD, 0603, 10k, 1/10W, 1%, TF, ROHS	VENKEL
CR0603-10W-1003FT	6	ea.	R13, R21, R28, R31, R44, R45	RES, SMD, 0603, 100k, 1/10W, 1%, TF, ROHS	VENKEL
CR0603-10W-1333FT	1	ea.	R23	RES, SMD, 0603, 133k, 1/10W, 1%, TF, ROHS	VENKEL
RC0603FR-07220RL	3	ea.	R32, R33, R34	RES, SMD, 0603, 220Ω, 1/10W, 1%, TF, ROHS	YAGEO
ERJ-3EKF4023V	1	ea.	R9	RES, SMD, 0603, 402k, 1/16W, 1%, TF, ROHS	PANASONIC
ERJ-3EKF5621V	1	ea.	R82	RES, SMD, 0603, 5.62k, 1/10W, 1%, TF, ROHS	PANASONIC
CR0603-10W-6041FT	1	ea.	R25	RES, SMD, 0603, 6.04k, 1/10W, 1%, TF, ROHS	VENKEL
ERJ-3EKF6980V	1	ea.	R27	RES, SMD, 0603, 698Ω, 1/10W, 1%, TF, ROHS	PANASONIC
WSLP1206R0100FEA	1	ea.	RS2	RES-CURR.SENSE, SMD, 1206, 0.01Ω, 1W, 1%, 75ppm, ROHS	VISHAY/DALE
WSLP1206R0200FEA	1	ea.	RS1	RES-CURR.SENSE, SMD, 1206, 0.02Ω, 1W, 1%, 75ppm, ROHS	VISHAY/DALE
GT11MSCBE	2	ea.	SW1, SW2	SWITCH-TOGGLE, SMD, 6PIN, SPDT, 2POS, ON-NONE-ON, ROHS	ITT INDUSTRIES/ C&K DIVISION
PMSSS 440 0025 PH	4	ea.	Four corners	SCREW, 4-40x1/4in, PHILLIPS, PANHEAD, STAINLESS, ROHS	BUILDING FASTENERS
2204	4	ea.	Four corners	STANDOFF, 4-40x3/4in, F/F, HEX, ALUMINUM, 0.25 OD, ROHS	KEYSTONE
212403-013	1	ea.	Place assembly in bag	BAG, STATIC, 5x8, ZIPLOC, ROHS	INTERSIL
	0	ea.	C19, C20, C25, C27, C39, C44, C88-C97	DO NOT POPULATE OR PURCHASE	
	0	ea.	JP1, JP2	DO NOT POPULATE OR PURCHASE	
	0	ea.	L2	DO NOT POPULATE OR PURCHASE	
	0	ea.	R3, R35, R37	DO NOT POPULATE OR PURCHASE	
	0	ea.	TP38-TP42	DO NOT POPULATE OR PURCHASE	
LABEL-DATE CODE	1	ea.	AFFIX TO BACK OF PCB	LABEL-DATE CODE_LINE 1: YRWK/REV#, LINE 2: BOM NAME	INTERSIL
LABEL-RENAME BOARD	1	ea.	RENAME PCB TO: ISL9238EVAL1Z.	LABEL, TO RENAME BOARD	INTERSIL

PCB Layout Guidelines

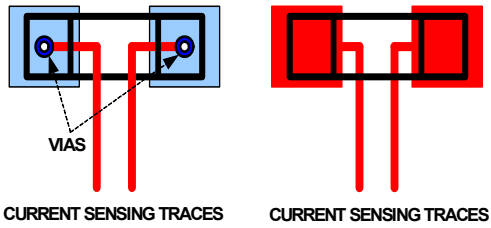
PIN NUMBER	PIN NAME	LAYOUT GUIDELINES
BOTTOM PAD 33	GND	Connect this ground pad to the ground plane through low impedance path. Recommend use of at least 5 vias to connect to ground planes in PCB to ensure there is sufficient thermal dissipation directly under the IC.
1	CSON	<p>Run two dedicated traces with decent width in parallel (close to each other to minimize the loop area) from the two terminals of the battery current sensing resistor to the IC. Place the differential mode and common-mode RC filter components in general proximity of the controller.</p> <p>Route the current sensing traces through vias to connect the center of the pads; or route the traces into the pads from the inside of the current sensing resistor. The following drawings show the two preferred ways of routing current sensing traces.</p> <div style="text-align: center;">  </div>
2	CSOP	
3	VSYS	Signal pin. Provides feedback for the system bus voltage. Place the optional RC filter in general proximity of the controller. Run a dedicated trace from system bus to the pin and do not route near the switching traces. Do not share the same trace with the signal routing to the DCIN pin OR diodes.
4	BOOT2	Switching pin. Place the bootstrap capacitor in general proximity of the controller. Use decent wide trace. Avoid any sensitive analog signal trace from crossing over or getting close.
5	UGATE2	<p>Run these two traces in parallel fashion with decent width. Avoid any sensitive analog signal trace from crossing over or getting close. Recommend routing PHASE2 trace to high-side MOSFET source pin instead of general copper.</p> <p>The IC should be placed close to the switching MOSFET's gate terminals and keep the gate drive signal traces short for a clean MOSFET drive. The IC can be placed on the opposite side of the switching MOSFETs.</p> <p>Place the output capacitors as close as possible to the switching high-side MOSFET drain and the low-side MOSFET source; and use shortest PCB trace connection. Place these capacitors on the same PCB layer with the MOSFETs instead of on different layers and using vias to make the connection.</p> <p>Place the inductor terminal to the switching high-side MOSFET drain and low-side MOSFET source terminal as close as possible. Minimize this phase node area to lower the electrical and magnetic field radiation but make this phase node area big enough to carry the current. Place the inductor and the switching MOSFETs on the same layer of the PCB.</p>
6	PHASE2	
7	LGATE2	Switching pin. Run LGATE2 trace in parallel with UGATE2 and PHASE2 traces on the same PCB layer. Use decent width. Avoid any sensitive analog signal trace from crossing over or getting close.
8	VDDP	Place the decoupling capacitor in general proximity of the controller. Run the trace connecting to VDD pin with decent width.
9	LGATE1	Switching pin. Run LGATE1 trace in parallel with UGATE1 and PHASE1 traces on the same PCB layer. Use decent width. Avoid any sensitive analog signal trace from crossing over or getting close.

PCB Layout Guidelines (Continued)

PIN NUMBER	PIN NAME	LAYOUT GUIDELINES
10	PHASE1	Run these two traces in parallel fashion with decent width. Avoid any sensitive analog signal trace from crossing over or getting close. Recommend routing PHASE1 trace to high-side MOSFET source pin instead of general copper.
11	UGATE1	<p>The IC should be placed close to the switching MOSFET's gate terminals and keep the gate drive signal traces short for a clean MOSFET drive. The IC can be placed on the opposite side of the switching MOSFETs.</p> <p>Place the input capacitors as close as possible to the switching high-side MOSFET drain and the low-side MOSFET source, and use shortest PCB trace connection. Place these capacitors on the same PCB layer with the MOSFETs instead of on different layers and using vias to make the connection.</p> <p>Place the inductor terminal to the switching high-side MOSFET drain and low-side MOSFET source terminal as close as possible. Minimize this phase node area to lower the electrical and magnetic field radiation but make this phase node area big enough to carry the current. Place the inductor and the switching MOSFETs on the same layer of the PCB.</p>
12	BOOT1	Switching pin. Place the bootstrap capacitor in general proximity of the controller. Use decent wide trace. Avoid any sensitive analog signal trace from crossing over or getting close.
13	ASGATE	Run this trace with decent width in parallel fashion with the ADP pin trace.
14	CSIN	Run two dedicated traces with decent width in parallel (close to each other to minimize the loop area) from the two terminals of the adapter current sensing resistor to the IC. Place the differential mode and common-mode RC filter components in general proximity of the controller.
15	CSIP	<p>Route the current sensing traces through vias to connect the center of the pads, or route the traces into the pads from the inside of the current sensing resistor. The following drawings show the two preferred ways of routing current sensing traces.</p> <div style="text-align: center;"> </div>
16	ADP	Run this trace with decent width in parallel fashion with the ASGATE pin trace.
17	DCIN	Place the OR diodes and the RC filter in general proximity of the controller. Run the VADP trace and VSYS trace to the OR diodes with decent width.
18	VDD	Place the RC filter connecting with VDDP pin in general proximity of the controller. Run the trace connecting to VDDP pin with decent width.
19	ACIN	Place the voltage divider resistors and the optional decoupling capacitor in general proximity of the controller.
20	OTGEN/CMIN	No special consideration.
21	SDA	Digital pins. No special consideration. Run SDA and SCL traces in parallel.
22	SCL	
23	PROCHOT#	Digital pin, open-drain output. No special consideration.
24	ACOK	
25	BATGONE	Digital pin. Place the 100kΩ resistor series in the BATGONE signal trace and the optional decoupling capacitor in general proximity of the controller.
26	OTGPG/CMOUT	Digital pin, open-drain output. No special consideration.
27	PROG	Signal pin. Place the PROG programming resistor in general proximity of the controller.
28	COMP	Place the compensation components in general proximity of the controller. Avoid any switching signal from crossing over or getting close.
29	AMON/BMON	No special consideration. Place the optional RC filter in general proximity of the controller.

PCB Layout Guidelines (Continued)

PIN NUMBER	PIN NAME	LAYOUT GUIDELINES
30	PSYS	Signal pin, current source output. No special consideration.
31	VBAT	Place the optional RC filter in general proximity of the controller. Run a dedicated trace from the battery positive connection point to the IC.
32	BGATE	Use decent width trace from the IC to the BGATE MOSFET gate. Place the capacitor from BGATE to ground close to the MOSFET.

Board Layout

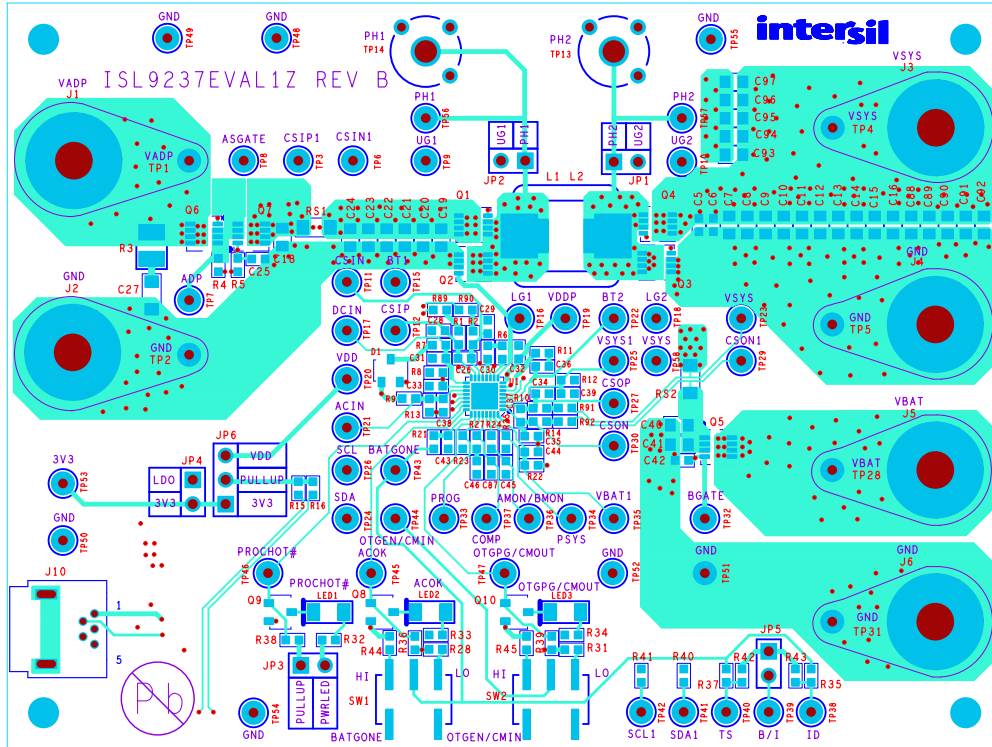

FIGURE 9. TOP LAYER

Board Layout (Continued)

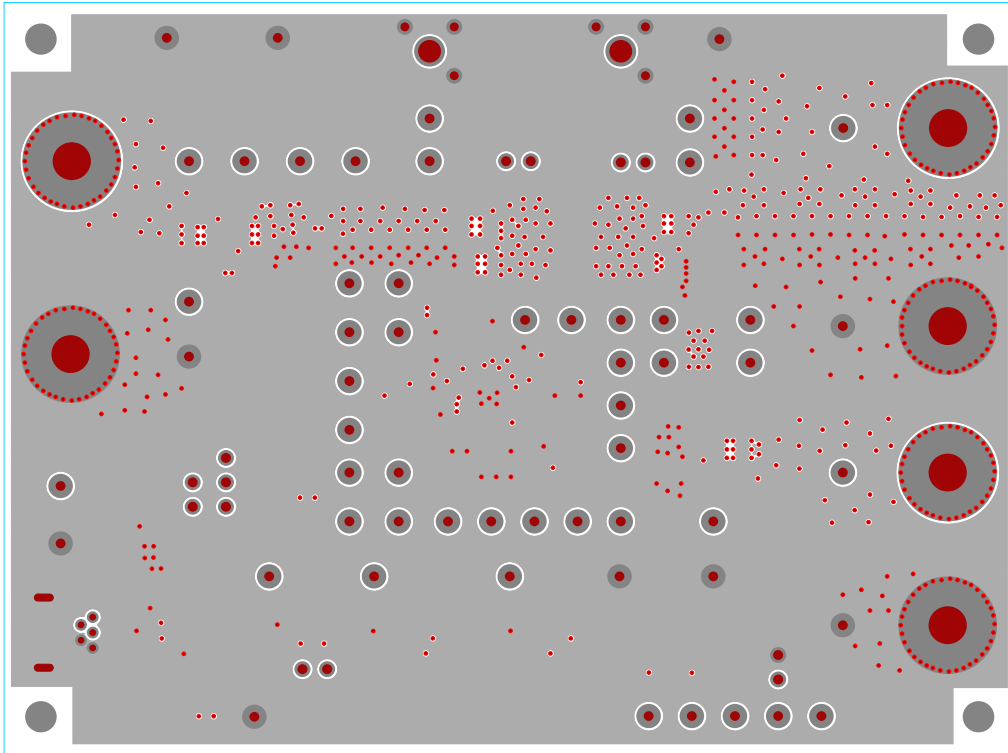

FIGURE 10. INNER LAYER 1

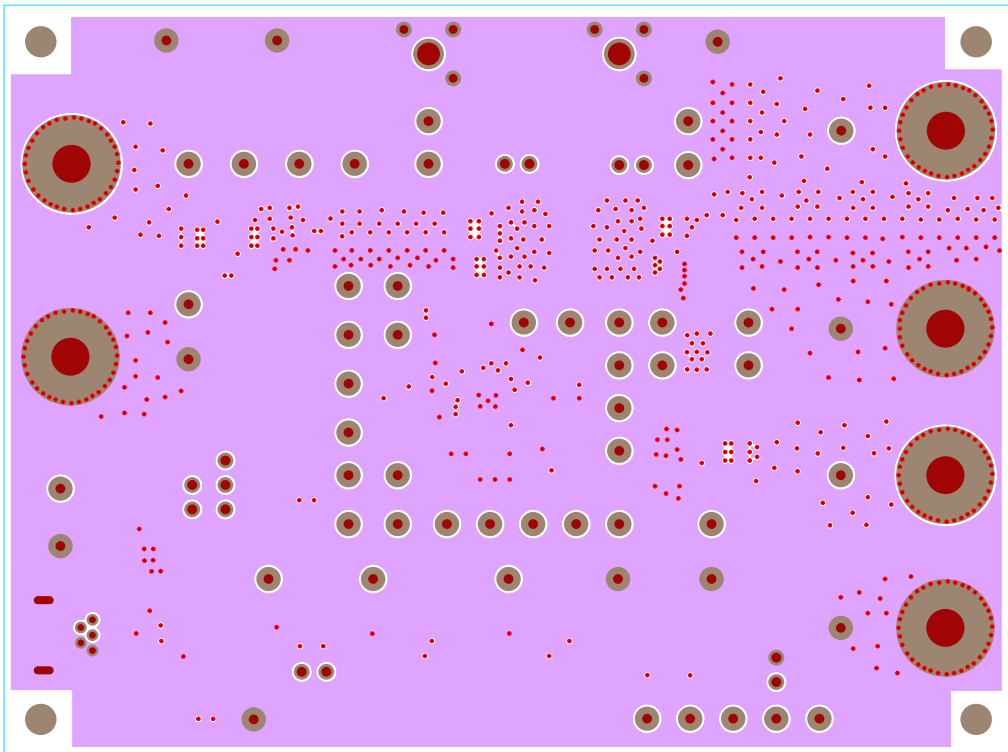

FIGURE 11. INNER LAYER 2

Board Layout (Continued)

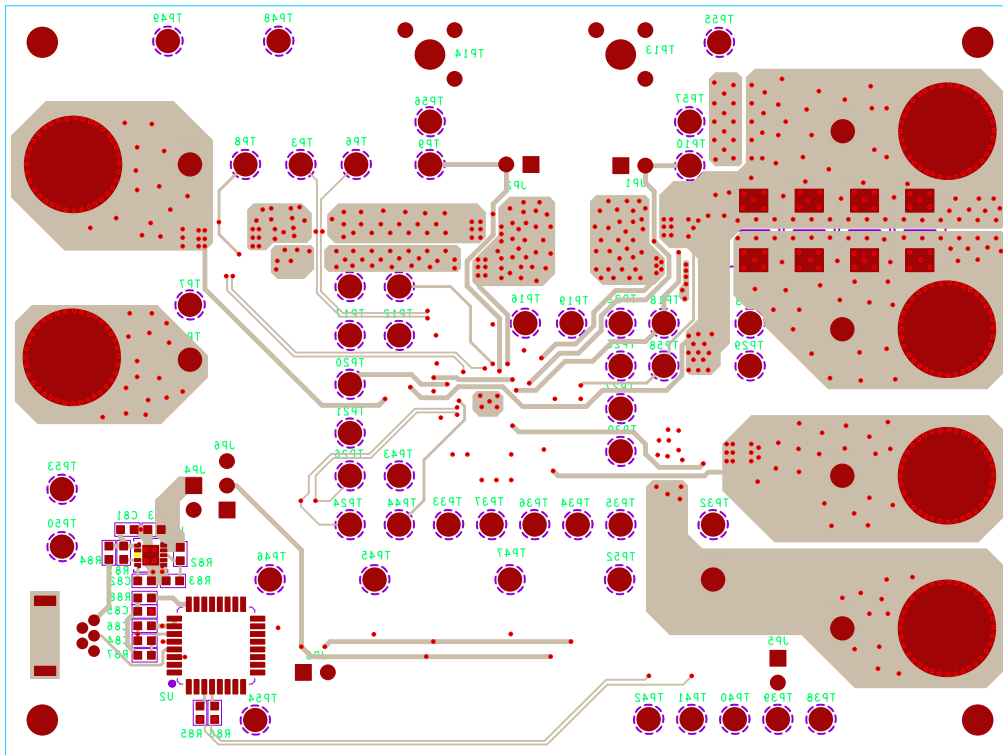

FIGURE 12. BOTTOM LAYER

Typical Performance

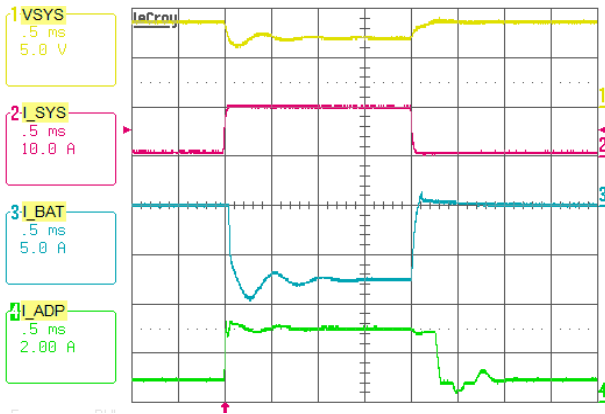

FIGURE 13. BOOST MODE, OUTPUT VOLTAGE LOOP TO ADAPTER CURRENT LOOP TRANSITION. $V_{ADP} = 5V$, $MAXSYSTEMVOLTAGE = 8.496V$, $V_{BAT} = 7V$, SYSTEM LOAD 0.5A TO 10A STEP, ADAPTERCURRENTLIMIT = 3A, CHARGECURRENT = 0A

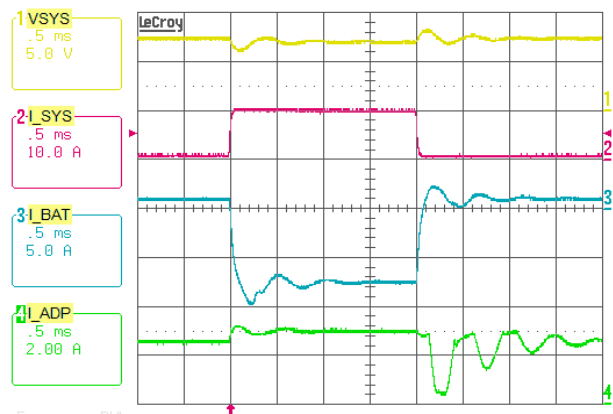

FIGURE 14. BOOST MODE, CHARGING CURRENT LOOP TO ADAPTER CURRENT LOOP TRANSITION. $V_{ADP} = 5V$, $MAXSYSTEMVOLTAGE = 8.496V$, $V_{BAT} = 7V$, SYSTEM LOAD 0.5A TO 10A STEP, ADAPTERCURRENTLIMIT = 3A, CHARGECURRENT = 1A

Typical Performance (Continued)

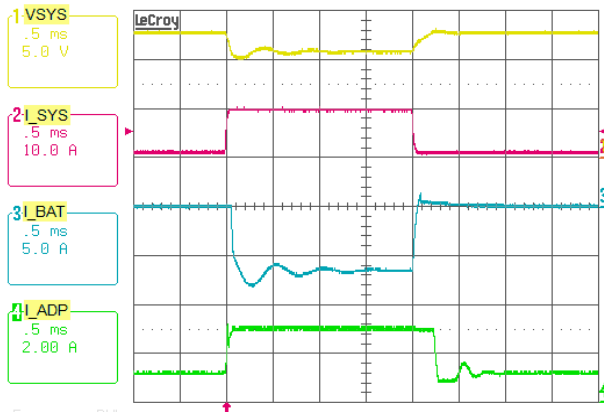

FIGURE 15. BUCK-BOOST MODE, OUTPUT VOLTAGE LOOP TO ADAPTER CURRENT LOOP TRANSITION. $V_{ADP} = 12V$, $MAXSYSTEMVOLTAGE = 12.6V$, $V_{BAT} = 11V$, SYSTEM LOAD 1A TO 10A STEP, $ADAPTERCURRENTLIMIT = 3A$, $CHARGECURRENT = 0A$

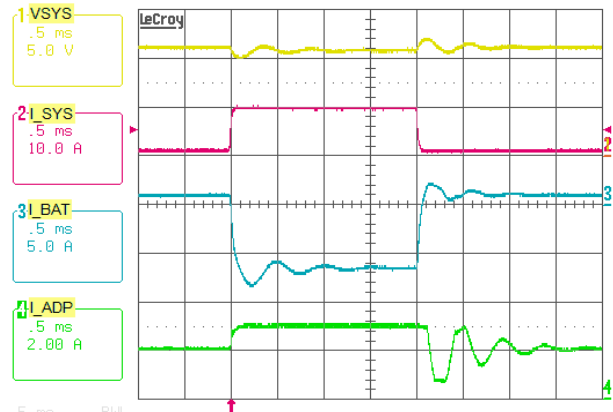

FIGURE 16. BUCK-BOOST MODE, CHARGING CURRENT LOOP TO ADAPTER CURRENT LOOP TRANSITION. $V_{ADP} = 12V$, $MAXSYSTEMVOLTAGE = 12.6V$, $V_{BAT} = 11V$, SYSTEM LOAD 1A TO 10A STEP, $ADAPTERCURRENTLIMIT = 3A$, $CHARGECURRENT = 1A$

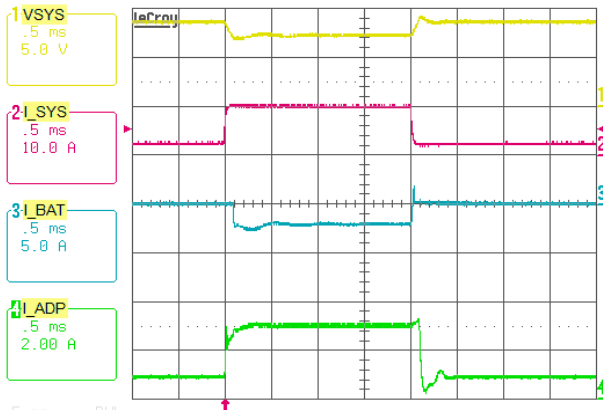

FIGURE 17. BUCK MODE, OUTPUT VOLTAGE LOOP TO ADAPTER CURRENT LOOP TRANSITION. $V_{ADP} = 20V$, $MAXSYSTEMVOLTAGE = 8.496V$, $V_{BAT} = 7V$, SYSTEM LOAD 2A TO 10A STEP, $ADAPTERCURRENTLIMIT = 3A$, $CHARGECURRENT = 0A$

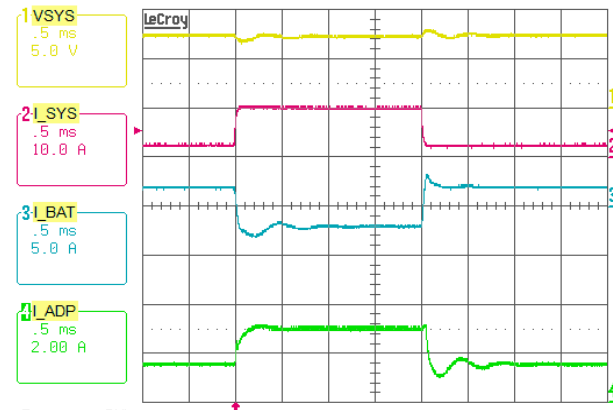

FIGURE 18. BUCK MODE, CHARGING CURRENT LOOP TO ADAPTER CURRENT LOOP TRANSITION. $V_{ADP} = 20V$, $MAXSYSTEMVOLTAGE = 8.496V$, $V_{BAT} = 7V$, SYSTEM LOAD 2A TO 10A STEP, $ADAPTERCURRENTLIMIT = 3A$, $CHARGECURRENT = 2A$

Typical Performance (Continued)

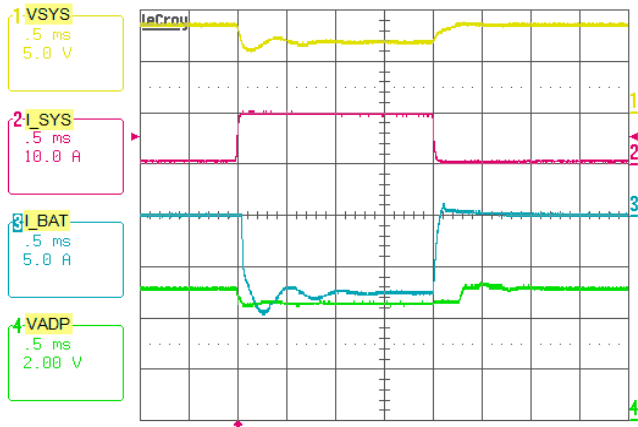

FIGURE 19. BOOST MODE, OUTPUT VOLTAGE LOOP TO INPUT VOLTAGE LOOP TRANSITION. $V_{ADP} = 5V$, $MAXSYSTEMVOLTAGE = 8.496V$, $V_{BAT} = 7V$, $VINDAC = 4.5V$, SYSTEM LOAD 0.5A TO 10A STEP, $CHARGECURRENT = 0A$

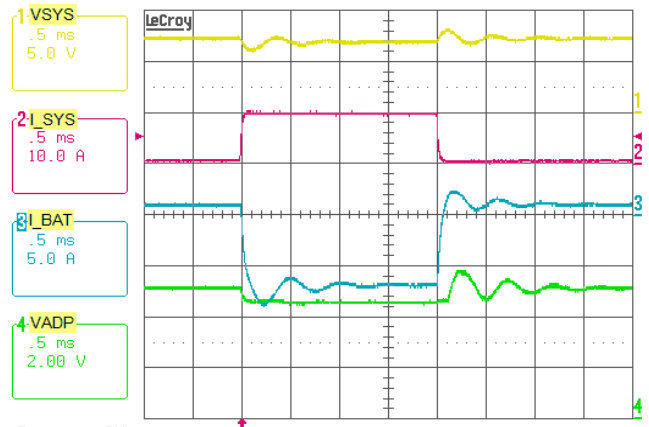

FIGURE 20. BOOST MODE, CHARGING CURRENT LOOP TO INPUT VOLTAGE LOOP TRANSITION. $V_{ADP} = 5V$, $MAXSYSTEMVOLTAGE = 8.496V$, $V_{BAT} = 7V$, $VINDAC = 4.5V$, SYSTEM LOAD 0.5A TO 10A STEP, $CHARGECURRENT = 1A$

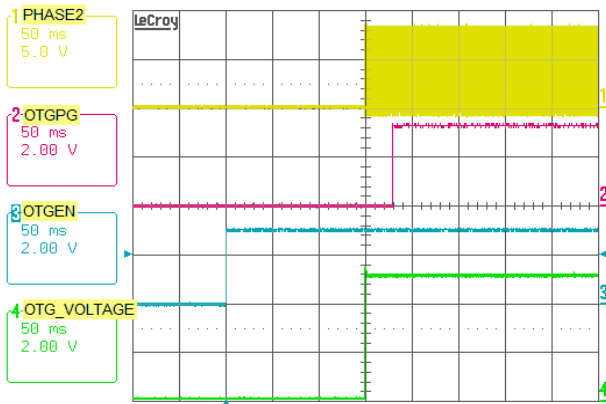

FIGURE 21. OTG MODE ENABLE, OTG ENABLE 150ms DEBOUNCE TIME

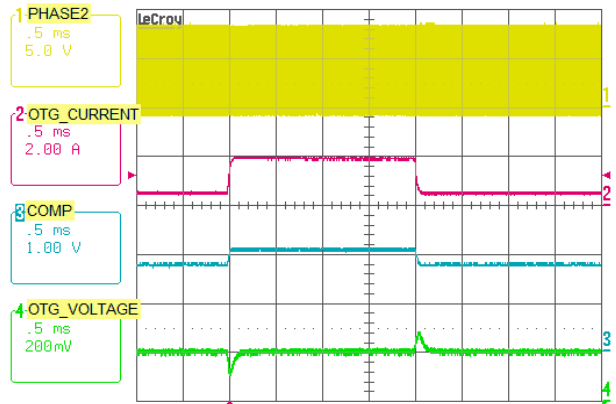

FIGURE 22. OTG MODE 0.5A TO 2A TRANSIENT LOAD, OTG VOLTAGE = 5.12V

Intersil Corporation reserves the right to make changes in circuit design, software and/or specifications at any time without notice. Accordingly, the reader is cautioned to verify that the document is current before proceeding.

For information regarding Intersil Corporation and its products, see www.intersil.com