



T3-B-LS

Mechanical and Electrical Specifications

Poles and Circuits: SPST (ON/OFF)
 Max Current: 0.25A
 Max Voltage: 30VDC Resistive
 Max Power: 0.24 W
 Mechanical Life: 1 Million operations (Typical)
 Angles of Operation:
 11 degrees above horizontal typical actuation
 6 degrees above horizontal typical return
 Return to resting state response time:
 2.5s Typical
 9s Max Typical (Gyrational Disturbance)

Dimensions

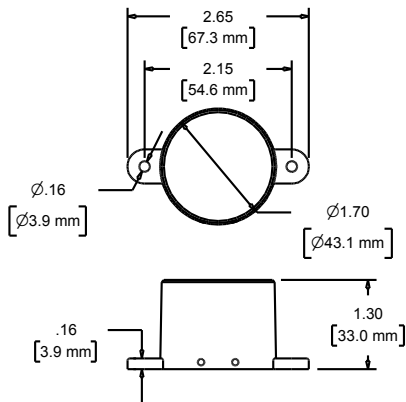

Materials

Housing:
 sealed black ABS (Flame Rated: 94HB min)
 Wire Leads:
 2x 20 AWG stranded black SXL insulated

Environmental Specifications

Operating Temperature Range:
 -40°F / -40°C to 165°F / 74°C
 Humidity: Outdoor, not to be submerged
 Magnetic Field: Performs normally in weak or absent magnetic fields. Operation is not affected by ferrous environments

Signal Debounce

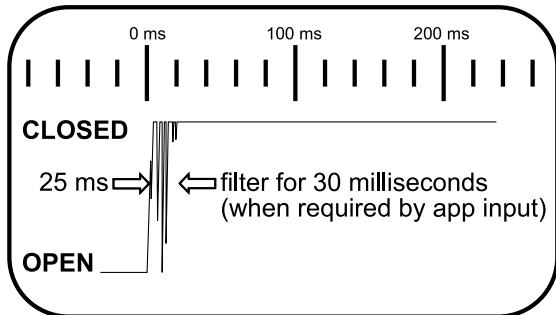

Features

- RoHS Compliant
- Non-Mercury Switch
- Industrial Grade
- No standby power consumption
- Magnetic switching improves vibratory contact stability over non-mercury alternatives

Angles of Operation

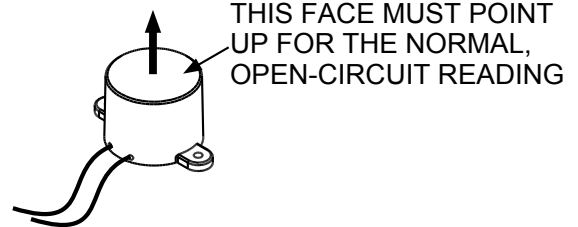
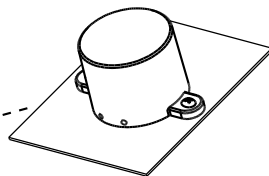
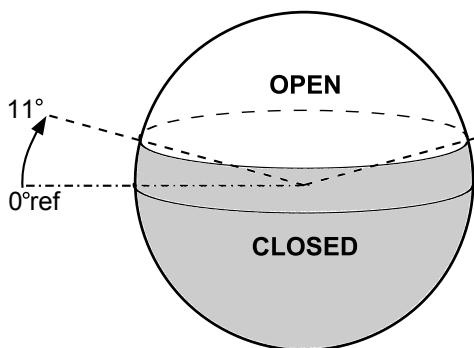

Ready to install "as-is" for industrial environments

Mounting

Mount using 2 pan-head screws, size #6 or 3.5mm. Alternatively, double-sided mounting tape may be used where conditions permit (ex: automotive trim grade). Universal mounting bracket(s) sold separately (p/n:1608)

Mounting Site

Mounting the switch near the expected tilt fulcrum will provide the most responsive reading. Mounting the switch far from the fulcrum will increase undesired centrifugal effects on the switch in quick-moving applications.

Debounce Techniques

Some applications may require contact debounce filtering, necessary for coping with the contact bounce of nearly any mechanical switch or pushbutton. For digital inputs, a debounce filter may be applied via software programming or by using a hardware low-pass filter. Please check your controller documentation; debounce filtering may already be available as a default. For analog applications, a hardware filter can be included in the circuit. Many detailed resources can be found online by searching using terms: CONTACT DEBOUNCE FILTER CIRCUIT

Application Notes

1. Magnasphere's tilt sensor is a switch, which provides great potential for power savings to wireless devices and stand-by systems.
2. This switch is constructed to be install-ready for industrial and outdoor equipment.
3. Wireless tilt sensing available for alarm panels and other applications: Contact Magnasphere details
4. The T3 will also sense disturbance, sudden movement along the mounting plane. Digital controller filters can nullify this attribute if only tilt sensing is desired.
5. Control loads above the maximum ratings by using a diode-protected or solid-state relay.
6. If the level position is meant to be normal condition for the panel input, insure the controller can (and is set to) accept open circuit as normal.

Ideal Uses Include:

- ATM tilt and disturbance
- Manhole cover and hatch disturbance
- Secure container, vitrine, and vault disturbance & tip
- Vending machine and appliance tip
- Compressors, pumps, power equipment, chemical container, and coolant compressor tip-over
- Heavy equipment stabilizer level indication and control interlock
- Showpiece disturbance & tip
- Auxiliary wireless input for alarm panels, home automation, and remote indication services
- Agricultural equipment: boom, hopper, loader, tank position

**SURFACE MOUNT:
FASTENERS OR DOUBLE-
SIDED MOUNTING TAPE**

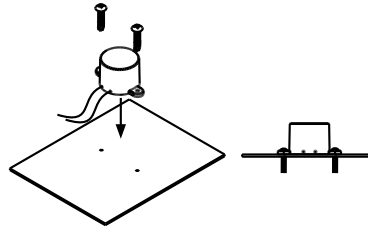

**PANEL MOUNT
THROUGH**

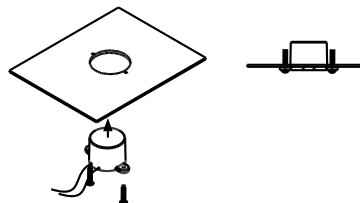

**PANEL MOUNT
UNDER**

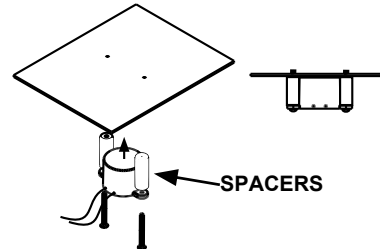

**USE AN ANGLE
BRACKET FOR
VERTICAL
SURFACES**

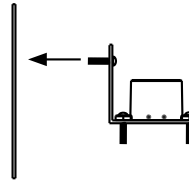

**UNIVERSAL BRACKET(S) - P/N: 1608
(sold separately)**

For complex mounting scenarios use universal brackets (p/n: 1608 sold separately). * Two brackets can be used to achieve rotation in 3 axes, to nearly any compound angle.

