

AIMB-502

**Intel® Xeon® E3/Core™ i7/i5/i3
LGA1155 MicroATX with CRT/
DVI/HDMI, 6 COM, Dual LAN,
DDR3, PCIe x 16, USB 3.0 and
SATAIII**

Copyright

The documentation and the software included with this product are copyrighted 2013 by Advantech Co., Ltd. All rights are reserved. Advantech Co., Ltd. reserves the right to make improvements in the products described in this manual at any time without notice.

No part of this manual may be reproduced, copied, translated or transmitted in any form or by any means without the prior written permission of Advantech Co., Ltd. Information provided in this manual is intended to be accurate and reliable. However, Advantech Co., Ltd. assumes no responsibility for its use, nor for any infringements of the rights of third parties, which may result from its use.

Acknowledgements

IBM and PC are trademarks of International Business Machines Corporation.

Intel® Core™ i7/i5/i3 Celeron® is trademark of Intel Corporation

All other product names or trademarks are properties of their respective owners.

A Message to the Customer

Advantech Customer Services

Each and every Advantech product is built to the most exacting specifications to ensure reliable performance in the harsh and demanding conditions typical of industrial environments. Whether your new Advantech equipment is destined for the laboratory or the factory floor, you can be assured that your product will provide the reliability and ease of operation for which the name Advantech has come to be known.

Your satisfaction is our primary concern. Here is a guide to Advantech's customer services. To ensure you get the full benefit of our services, please follow the instructions below carefully.

Technical Support

We want you to get the maximum performance from your products. So if you run into technical difficulties, we are here to help. For the most frequently asked questions, you can easily find answers in your product documentation. These answers are normally a lot more detailed than the ones we can give over the phone.

So please consult this manual first. If you still cannot find the answer, gather all the information or questions that apply to your problem, and with the product close at hand, call your dealer. Our dealers are well trained and ready to give you the support you need to get the most from your Advantech products. In fact, most problems reported are minor and are able to be easily solved over the phone.

In addition, free technical support is available from Advantech engineers every business day. We are always ready to give advice on application requirements or specific information on the installation and operation of any of our products.

Part No. 2006050200

Printed in China

Edition 1

July 2013

Declaration of Conformity

FCC Class B

This device complies with the requirements in part 15 of the FCC rules:

Operation is subject to the following two conditions:

- This device may not cause harmful interference
- This device must accept any interference received, including interference that may cause undesired operation.

This equipment has been tested and found to comply with the limits for a Class B digital device, pursuant to Part 15 of the FCC Rules. These limits are designed to provide reasonable protection against harmful interference when the equipment is operated in a commercial environment. This equipment generates, uses, and can radiate radio frequency energy and, if not installed and used in accordance with the instruction manual, may cause harmful interference to radio communications. Operation of this device in a residential area is likely to cause harmful interference in which case the user will be required to correct the interference at his/her own expense. The user is advised that any equipment changes or modifications not expressly approved by the party responsible for compliance would void the compliance to FCC regulations and therefore, the user's authority to operate the equipment.

Caution! *There is a danger of a new battery exploding if it is incorrectly installed. Do not attempt to recharge, force open, or heat the battery. Replace the battery only with the same or equivalent type recommended by the manufacturer. Discard used batteries according to the manufacturer's instructions.*



CPU Compatibility

LGA1155(3rd Generation Intel® Core™ i3,i5,i7 CPU)								
CPU Family	sSpec.	Core Stepping	Power	FSB (DMI)	Mfg. Tech	Smart cache	Package Type	Result
Intel® Core™ i7-3770 3.4G	SR0PK	E1	77W	5 GT/s	22nm	8MB	LGA1155	PASS
Intel® Core™ i3-3220 3.3G	SR0RG	L1	55W	5 GT/s	22nm	3MB	LGA1155	PASS
Intel® Core™ i5-3550 Processor 3.7G	SR0P0	E1	77W	5 GT/s	22nm	6MB	LGA1155	PASS
Intel® Pentium G2120 (3.10 GHz)	QCDB		55W	5 GT/s	22nm	3MB	LGA1155	PASS
LGA1155 (2nd Generation Intel® Sandy bridge Core i3,i5,i7)								
CPU Family	sSpec.	Core Stepping	Power	FSB (DMI)	Mfg. Tech	Smart cache	Package Type	Result
Intel® Core™ i3-2120 Processor 3.3 GHz	SR05Y	Q0	65W	5 GT/s	32nm	3MB	LGA1156	PASS
Intel® Core™ i5-2400 Processor 3.1GHz	SR00Q	D2	95W	5 GT/s	32nm	6MB	LGA1156	PASS
Intel® Core™ i7-2600 Processor 3.4 GHz	SR00B	D2	95W	5 GT/s	32nm	8MB	LGA1156	PASS
Intel® Celeron® Processor G540 2.5 GHz	SR05J		65W	5 GT/s	32nm	2MB	LGA1156	PASS
Intel® Pentium® Processor G850 2.90 GHz	SR05Q		65W	5 GT/s	32nm	8MB	LGA1156	PASS
Intel® Core™ i3-2120T Processor 2.6 GHz	Q1FR		35W	5 GT/s			LGA1156	PASS
Intel® Pentium® Processor G630T 2.3 GHz	Q1CT		35W	5 GT/s			LGA1156	PASS

Memory Compatibility

Brand	Size	Speed	Type	ECC	Vendor PN	Memory
Transcend	1GB	DDR3 1066	DDR3	N	TS128MLK64V1U	SEC K4B1G0846G-BCH9
Transcend	2GB	DDR3 1066	DDR3	N	TS256MLK64V1U	SEC K4B1G0846G-BCH9
Apacer	1GB	DDR3 1066	DDR3	N	78.01GC3.420	ELPIDAJ1108BDBG-DJ-F (128x8)
Apacer	2GB	DDR3 1066	DDR3	N	78.A1GC3.421	ELPIDAJ1108BDBG-DJ-F (128x8)
Apacer	4GB	DDR3 1066	DDR3	N	78.B1GDJ.AF1	HYNIX H5TQ2G83BFR- H9C
Transcend	1GB	DDR3 1333	DDR3	N	TS128MLK64V3U	ELPIDA EDJ1108BFBG- DJ-F
Transcend	2GB	DDR3 1333	DDR3	N	TS256MLK64V3U	SEC K4B1G0846G-BCH9
Transcend	4GB	DDR3 1333	DDR3	N	TS512MLK64V3N	HYNIX H5TQ2G83CFR H9C 256x8
Transcend	8GB	DDR3 1333	DDR3	N	TS1GLK64V3H	MICRON IWD27 D9PBC
Apacer	1GB	DDR3 1333	DDR3	N	78.01GC6.AF0	H5TQ1G83DFR-H9C H5TQ1G83TFR-H9C
Apacer	2GB	DDR3 1333	DDR3	N	78.A1GDE.4200C	ELPIDA J2108BCSE-DJ-F
Apacer	2GB	DDR3 1333	DDR3	N	78.A1GDE.AF00C	Hynix H5TQ2G838FR(256x8)
Apacer	4GB	DDR3 1333	DDR3	N	78.B1GDE.AF1	HYNIX H5TQ2G83BFR- H9C
Apacer	4GB	DDR3 1333	DDR3	N	78.B1GDE.AF1	HYNIX H5TQ2G83BFR H9C 256x8
Apacer	8GB	DDR3 1333	DDR3	N	78.C1GEP.4210C	ELPIDA J4208BASE-DJ-F 512x8
Kingston	2GB	DDR3 1333	DDR3	N	KVR1333D3S8N9/2G	ELPIDA J2108BCSE-DJ- F(128x8)
Kingston	4GB	DDR3 1333	DDR3	N	KVR1333D3N9/4G	KINGSTON D2568JENC PGD9U(512x 64)
ATP	2GB	DDR3 1600	DDR3	N	XQ16A8N2GS-9-AV	SEC K4B2G0846D (256x8)
ATP	2GB	DDR3 1600	DDR3	N	XQ16A8N2GM-9-AV	MICRON 2HM77 D9PFJ (256x8)
ATP	4GB	DDR3 1600	DDR3	N	XQ16B8N4GS-9-AV	SEC K4B2G0846D (256x8)
ATP	8GB	DDR3 1600	DDR3	N	XQ16B8N8GS-9-AV	SEC K4B4G0846B (512x8)
Apacer	8GB	DDR3 1600	DDR3	N	78.C1GET.ATF0C	Micron 2FD27 D9PCP (512x8)
DSL	2GB	DDR3 1600	DDR3	N	D3US56081XH12AA	SEC 113 HCK0 K4B2G0846C 256x8
DSL	4GB	DDR3 1600	DDR3	N	D3US56082XH12AA	SEC 113 HCK0 K4B2G0846C 256x8

DSL	8GB	DDR3 1600	DDR3	N	D3UE12082XH12AA	ELPIDA J4208BBBG-GN-F
DSL	8GB	DDR3 1600	DDR3	ECC	D3EE12082XH12AA	ELPIDA J4208BBBG-GN-F
Transcend	2GB	DDR3 1600	DDR3	N	TS256MLK64V6N	MICRON IRM72 D9PFJ
Transcend	4GB	DDR3 1600	DDR3	N	TS512MLK64V6N	MICRON IUM22 D9PFJ
Transcend	4GB	DDR3 1600	DDR3	N	TS512MLK64V6N	MICRON 2EM77 D9PFJ 256x8
Transcend	8GB	DDR3 1600	DDR3	N	TS1GLK64V6H	micron IZD27 D9PBC 512x8

Ordering Information

Model	Chipset	Memory	GbE LAN	USB 2.0/3.0	CRT	HDMI	DVI-D	SATA III / II	eSATA / mSATA	COM	PCIe	mini PCIe	TPM
AIMB-502QG2-00A1E	Q77	Non-ECC	2	2 / 4	1	1	1	2 / 6	1 / 1	6	PCIe 16 x1 PCIe 1 x 1	1	(1)
AIMB-502WG2-00A1E	C216	ECC/ Non-ECC	2	2 / 4	1	1	1	2 / 2	1 / 1	6	PCIe 8 x 2 (PCIe 16 slot) PCIe 1 x 1	1	(1)

*() means do not populated on MP version.

Product Warranty (2 years)

Advantech warrants to you, the original purchaser, that each of its products will be free from defects in materials and workmanship for two years from the date of purchase.

This warranty does not apply to any products which have been repaired or altered by persons other than repair personnel authorized by Advantech, or which have been subject to misuse, abuse, accident or improper installation. Advantech assumes no liability under the terms of this warranty as a consequence of such events.

Because of Advantech's high quality-control standards and rigorous testing, most of our customers never need to use our repair service. If an Advantech product is defective, it will be repaired or replaced at no charge during the warranty period. For out-of-warranty repairs, you will be billed according to the cost of replacement materials, service time and freight. Please consult your dealer for more details.

If you think you have a defective product, follow these steps:

1. Collect all the information about the problem encountered. (For example, CPU speed, Advantech products used, other hardware and software used, etc.) Note anything abnormal and list any onscreen messages you get when the problem occurs.
2. Call your dealer and describe the problem. Please have your manual, product, and any helpful information readily available.
3. If your product is diagnosed as defective, obtain an RMA (return merchandise authorization) number from your dealer. This allows us to process your return more quickly.
4. Carefully pack the defective product, a fully-completed Repair and Replacement Order Card and a photocopy proof of purchase date (such as your sales receipt) in a shippable container. A product returned without proof of the purchase date is not eligible for warranty service.
5. Write the RMA number visibly on the outside of the package and ship it prepaid to your dealer.

Initial Inspection

Before you begin installing your motherboard, please make sure that the following materials have been shipped:

- 1 x AIMB-502 Intel LGA 1155 Xeon E3 & Core i7/i5/i3 Micro ATX Motherboard
- 2 x SATA HDD cable
- 2 x SATA Power cable
- 1 x I/O port bracket
- 1 x Startup manual
- 1 x Driver CD
- 1 x Warranty card

If any of these items are missing or damaged, contact your distributor or sales representative immediately. We have carefully inspected the AIMB-502 mechanically and electrically before shipment. It should be free of marks and scratches and in perfect working order upon receipt. As you unpack the AIMB-502, check it for signs of shipping damage. (For example, damaged box, scratches, dents, etc.) If it is damaged or it fails to meet the specifications, notify our service department or your local sales representative immediately. Also notify the carrier. Retain the shipping carton and packing material for inspection by the carrier. After inspection, we will make arrangements to repair or replace the unit.

Contents

Chapter 1 General Information1

1.1	Introduction	2
1.2	Features	2
1.3	Specifications	2
1.3.1	System	2
1.3.2	Memory	2
1.3.3	Input/Output	2
1.3.4	Graphics.....	3
1.3.5	Ethernet LAN	3
1.3.6	Industrial features	3
1.3.7	Mechanical and environmental specifications.....	3
1.4	Jumpers and Connectors	4
	Table 1.1: Jumpers.....	4
	Table 1.2: Connectors	4
1.5	Board layout: Jumper and Connector Locations	5
	Figure 1.1 Jumper and Connector Location	5
	Figure 1.2 I/O Connectors	5
1.6	AIMB-502 Board Diagram	6
	Figure 1.3 AIMB-502 Block Diagram	6
1.7	Safety Precautions	7
1.8	Jumper Settings	7
1.8.1	How to Set Jumpers.....	7
1.8.2	CMOS Clear (CMOS1)	8
	Table 1.3: CMOS1	8
1.8.3	JOBS1+JWD1: Watchdog Timer Output and OBS Alarm Option)	8
	Table 1.4: JOB1+JWDT1	8
1.8.4	PSON1: ATX, AT Mode Selector	9
	Table 1.5: PSON1: ATX, AT Mode Selector.....	9
1.8.5	JME1:BIOS Update ME Mode Selector	9
	Table 1.6: BIOS update ME mode selector	9
1.8.6	JCASE1: Case Open Sensor.....	9
1.9	System Memory	10
1.10	Memory Installation Procedures.....	10
1.11	Cache Memory.....	10
1.12	Processor Installation.....	10
1.13	PCI Bus Routing Table.....	11

Chapter 2 Connecting Peripherals13

2.1	Introduction	14
2.2	LAN / USB Ports (LAN1_USB01/LAN2_USB23/USB89).....	14
	Table 2.1: LAN LED Indicator.....	14
2.3	Line Out, Mic In Connector (AUDIO1).....	15
2.4	VGA/DVI-D Connector (VGA1+DVI 1) Connector.....	15
2.5	Serial Ports (COM1~COM6)	16
2.6	HDMI Port	17
2.7	eSATA Port	17
2.8	CPU Fan Connector (CPU_FAN1).....	18
2.9	System FAN Connector (SYSFAN1/2/3/4).....	18
2.10	Front Panel Connectors (JFP1/JFP2/JFP3).....	19
2.10.1	ATX soft power switch ((JFP1/PWR_SW)).....	19
2.10.2	Reset (JFP1/RESET).....	19
2.10.3	HDD LED (JFP1/HDDLED).....	19
2.10.4	External speaker (JFP1/SPEAKER).....	19

2.10.5	Power LED and keyboard lock connector (JFP3/PWR_LED & KEY LOCK).....	20
	Table 2.2: ATX power supply LED status (No support for AT power)	20
2.11	Mini PCIe & mSATA Slot	20
2.12	Serial ATA Interface (SATARAID1 ~ SATARAID4)	21
2.13	Serial ATA Interface (SATA1 ~ SATA4).....	21
2.14	Digital IO connector (DIO1).....	22
2.15	PCI Express x16 Slot (QG2: 1 slot/WG2: 2 slots).....	23
2.16	Front Panel Audio Connector (FPAUD1)	24
2.17	ATX Power Connector (EATXPWR1, ATX12V1).....	25
2.18	SPI Flash connector(SPI_CN1)	26

Chapter 3 BIOS Operation 27

3.1	Introduction	28
3.2	BIOS Setup	28
3.3	Main Menu	29
3.4	Advanced BIOS Features	30
3.4.1	ACPI Settings	30
3.4.2	Trusted Computing:	31
3.4.3	S5 RTC Wake Settings.....	32
3.4.4	CPU Configuration.....	32
3.4.5	SATA Configuration.....	34
3.4.6	Intel TXT (LT) Configuration	35
3.4.7	PCH-FW Configuration.....	36
3.4.8	AMT Configuration.....	37
3.4.9	USB Configuration.....	38
3.4.10	Super IO Configuration.....	39
3.4.11	H/W Monitor.....	43
3.4.12	Serial Port Console Redirection.....	44
3.4.13	CPU PPM Configuration.....	45
3.5	Chipset Configuration Setting	46
3.5.1	PCH-IO Configuration.....	46
3.5.2	System Agent (SA) Configuration.....	50
3.6	Boot Setting	54
3.7	Security Setting.....	55
3.8	Save & Exit Configuration.....	56

Chapter 4 Software Introduction & Service 57

4.1	Introduction	58
4.2	Value-Added Software Services	58
4.2.1	Software API.....	58
4.2.2	Software Utility.....	59

Chapter 5 Chipset Software Installation Utility 61

5.1	Before You Begin.....	62
5.2	Introduction	62
5.3	Windows XP/Windows 7 Driver Setup.....	63

Chapter 6 VGA Setup 65

6.1	Introduction	66
6.2	Windows 7/XP.....	66

Chapter	7	LAN Configuration.....	69
7.1		Introduction	70
7.2		Features	70
7.3		Installation	70
7.4		Windows® 7/XP Driver Setup (Intel 82579LM/82574L)	71
Appendix A		Programming the Watchdog Timer..	73
A.1		Programming the Watchdog Timer	74
A.1.1		Watchdog Timer Overview.....	74
A.1.2		Programming the Watchdog Timer	74
		Table A.1: Watchdog Timer Registers	76
A.1.3		Example Program	77
Appendix B		Pin Assignments	81
B.1		RS-232 Interface (COM2)	82
		Table B.1: RS232 Serial Port (COM2)	82
B.2		RS-232 Interface (COM3456)	82
		Table B.2: RS-232 Serial Port (COM3456).....	82
B.3		USB 2.0 Header (USB89)	83
		Table B.3: USB 2.0 Header (COM89).....	83
B.4		Serial ATA III (SATA 1~2)	83
		Table B.4: Serial ATA III (6Gb/s)	83
B.5		Serial ATA II (SATA 3~4, SATARAID1~4)	84
		Table B.5: Serial ATA II (3Gb/s)	84
B.6		AT/ATX Mode Connector (PSON1)	84
		Table B.6: AT/ATX Mode Connector (PSON1).....	84
B.7		ATX Power Connector (EATPWR1).....	85
		Table B.7: ATX 24 pin main power connector	85
B.8		ATX 12 V Connector (ATX12V1)	85
		Table B.8: ATX 4 pin main power connector (ATX12V1).....	85
B.9		CPU Fan Connector (CPUFAN1).....	86
		Table B.9: CPU Fan Connector (CPUFAN1)	86
B.10		System Fan Power Connector (SYS_FAN1~4)	86
		Table B.10: System Fan Power Connector (SYS_FAN1~4).....	86
B.11		Audio front panel connector (FPAUD1).....	86
		Table B.11: Audio front panel connector (FPAUD1).....	86
B.12		Digital IO connect (DIO1)	87
		Table B.12: Digital IO connector (DIO1)	87
B.13		LAN LED (LANLED1).....	87
		Table B.13: GbE LAN LED (LANLED1)	87
B.14		SPI Flash update connector (SPI_CN1)	88
		Table B.14: SPI flash update connector (SPI_CN1).....	88
B.15		COM5 / 6_RI selector Jumper setting (JSETCOM5_V1/ JSETCOM6_V1)	88
		Table B.15: COM5 / 6_RI selector Jumper setting (JSETCOM5_V1/	
		JSETCOM6_V1).....	88
B.16		Power Switch/HDD LED/Speaker (JFP1+JFP2)	89
		Table B.16: Power Switch/HDD LED/Speaker (JFP1+JFP2)	89
B.17		Power LED (JFP3)	89
		Table B.17: Power LED (JFP3).....	89
B.18		IrDA connector (JIR1)	90
		Table B.18: IrDA connector (JIR1).....	90
B.19		Case Open sensor (JCASE1)	90
		Table B.19: Case Open sensor (JCASE1).....	90
B.20		Case Open Mode Connector (JCASEOP_SW1)	90

	Table B.20:Case Open Mode Connector (JCASEOP_SW1).....	90
B.21	RS-485 terminator jumper setting (J485P)	91
	Table B.21:RS-485 terminator jumper setting (J485P/N)	91

Chapter 1

General Information

1.1 Introduction

AIMB-502 is designed with the Intel Q77/C216 for industrial applications that require both performance computing and enhanced power management capabilities. The motherboard supports Intel Core i7 3770 3.4GHz/ Core i5 3550S 3.0 GHz/ Core i3 3220 3.3 GHz/Pentium G850 2.9 GHz/Celeron G540 2.5 GHz processor up to 8 MB L3 cache and DDR3 1333/1600 up to 32GB. A rich I/O connectivity of 6 serial ports, 2 USB 2.0, 4 USB 3.0, dual GbE LAN, 1 eSATA, 1 mSATA (Mini-PCIe co-lay), 6 SATA II ports and 2 SATA III ports.

1.2 Features

- **Rich I/O connectivity:** Dual GbE LAN via PCIe x1 bus, 1 x PCI 32-bit/33 MHz PCI slots, 1 x PCIe x 16 slot (QG2 sku) or 2 x PCIe x 16 slots with PCIe x 8 signal (WG2 sku), 1 x PCIe x 1 slot (Gen 2), 2 USB 2.0 ports and 4 USB 3.0 ports.
- **Standard Micro ATX form factor with industrial feature:** The AIMB-502 is a full featured Micro ATX motherboard with balanced expandability and performance.
- **Wide selection of storage devices:** 6 SATAII, 2 SATAIII, 1 eSATA and 1 mSATA, customers benefit from the flexibility of using the most suitable storage device for larger capacity.
- **Optimized integrated graphic solution:** With Intel® Flexible Display Interface, it supports versatile display options and 32-bit 3D graphics engine.

1.3 Specifications

1.3.1 System

- **CPU:** Intel Core i7 3770 3.4GHz/ Core i5 3550S 3.0GHz/ Core i3 3220 3.3GHz
- **BIOS:** AMI EFI 64 Mbit SPI BIOS
- **System chipset:** Intel® Q77/C216
- **SATA hard disk drive interface:** 1, eSATA, 1 mSATA and six on-board SATA connectors with data transmission rate up to 300 MB, and two on-board SATA connectors with data transmission rate up to 600 MB

1.3.2 Memory

- **RAM:** Up to 32 GB in 4 slots 240-pin DIMM sockets. Supports dual-channel DDR3 1333/1600MHz SDRAM.
 - AIMB-502QG2 supports non-ECC unbuffered DIMMs and do not support any memory configuration that mixes non-ECC with ECC unbuffered DIMMs.
 - AIMB-502WG2 supports ECC buffered DIMMs.

Note! A 32-bit OS may not fully detected 4GB of RAM when 4 GB is installed.



1.3.3 Input/Output

- **PCIe slot:** 1 PCIe x16 expansion slot (QG2) or 2 PCIe x16 expansion slot with PCIe x8 signal (WG2), 1 PCIe x1 expansion slot
- **PCI Bus:** 1 PCI slots, 32-bit/33 MHz PCI 2.2 compliant

- **Serial port:** Six serial ports, one is RS-485 with Phoenix connector on rear side and five are RS-232.
- **USB port:** Supports up to 8 USB 2.0 ports with transmission rates up to 480 Mbps and 4 USB 3.0 ports with transmission rates up to 5 Gbps.
- **GPIO:** AIMB-502 supports 14-bit GPIO from super I/O for general purpose control application and 6 bit non-programmable GPIO via Phoenix connector on rear side and 8 bit programmable GPIO by pin header on board.

1.3.4 Graphics

- **Controller:** Intel® HD Graphics
- **Display memory:** 1 GB maximum shared memory with 2GB and above system memory installed
- **DVI:** Supports DVI up to resolution 1920 x 1200 @ 60Hz refresh rate
- **VGA:** Supports VGA up to resolution 2048 x 1536 @ 75Hz refresh rate
- **HDMI:** Supports HDMI max resolution 1920 x 1200 (1080P)
- **Triple Display:** CRT + DVI + HDMI
- **Dual Display:** CRT + DVI, CRT + HDMI, DVI + HDMI

1.3.5 Ethernet LAN

- Supports dual 10/100/1000 Mbps Ethernet port (s) via PCI Express x1 bus which provides 500 MB/s data transmission rate and support "Jumbo Frame" function
- **Controller:** LAN1: Intel 82579LM; LAN2: Intel 82574L

1.3.6 Industrial features

- **Watchdog timer:** Can generate a system reset. The watchdog timer is programmable, with each unit equal to one second or one minute (255 levels)

1.3.7 Mechanical and environmental specifications

- **Operating temperature:** 0 ~ 60° C (32 ~ 140° F, Depending on CPU)
- **Storage temperature:** -40 ~ 85° C (-40 ~ 185° F)
- **Humidity:** 5 ~ 95% non-condensing
- **Power supply voltage:** +3.3 V, +5 V, +12 V, -12 V, 5 Vsb
- **Power consumption:**
Intel LGA1155 Core i7 3770 3.4GHz, 8MB L3 Cache, 4pcs 8GB DDR3 1600MHz memory

+5 V	3.3 V	12 V	5 Vsb	-12 V
2.69 A	0.93 A	5.3 A	0.0 A	0.52 A

 Measure the maximum current value which system under maximum load (CPU: Top speed, RAM & Graphic: Full loading)
- **Board size:** 244 mm x 244 mm (9.6" x 9.6")
- **Board weight:** 0.365 kg

1.4 Jumpers and Connectors

Connectors on the AIMB-502 motherboard link it to devices such as hard disk drives and a keyboard. In addition, the board has a number of jumpers used to configure your system for your application.

The tables below list the function of each of the board jumpers and connectors. Later sections in this chapter give instructions on setting jumpers. Chapter 2 gives instructions for connecting external devices to your motherboard.

Table 1.1: Jumpers

Label	Function
JFP1	Power Switch / Reset connector
JFP2	External speaker / SATA HDD LED connector
JFP3	Power LED
JMECLR	ME Clear (Reset portions of Intel ME)
JCMOS1	CMOS clear (default 1-2 pin)
JOBS1 + JWDT1	JOBS Jumper for Watchdog/OBS
JSETCOM5/6_V1	COM5_6 Ring selector Jumper setting
JIR1	Jumper for Irda (Option)
JCASE1	Case open connector
JME1	Jumper for update BIOS ME mode
PSON1	AT(1-2) / ATX(2-3) (Default 2-3)

Table 1.2: Connectors

Label	Function
COM2	Serial Port COM2, pin header 2x5
COM3/4/5/6	COM3/4/5/6 serial port, box header 2 x 20 p
LAN1_USB01 LAN2_USB23	USB Port 0, 1, 2, 3 (USB 3.0) LAN1, LAN2 (Dual GbE LAN Port)
USB89	USB port 8-9 (internal 2 x 5 pin header on board)
FPAUD1	Front Panel audio connector (FP_AUDIO)
LANLED1	Front Panel LAN Indicator connector
AUDIO1/2	Audio Connector (Line Out, Mic in)
VGA1 + DVI1	VGA / DVI-D Connector
HDMI1	HDMI connector
ESATA1	External Serial ATA Connector
ISODIO1	RS485/GPIO (6 bit) Phoenix connector
CPUFAN1	CPU FAN connector (4 pin)
SYSFAN1/2/3/4	System FAN Power Connector (3 pin)
ATX12V1	ATX 12V Auxiliary power connector (2 x 2 p)
EATXPWR1	ATX power connector (2 x 12 p)
SATA1~2	SATA connector (support SATAIII)
SATA3~4	SATA connector (support SATAII)
SATARAID1~4	SATA connector (support SATAII)
MINIPCIELATCH1	Mini PCIe slot (support mSATA)
SPI_CN1	SPI flash card pin header (2 x 4p)

1.5 Board layout: Jumper and Connector Locations

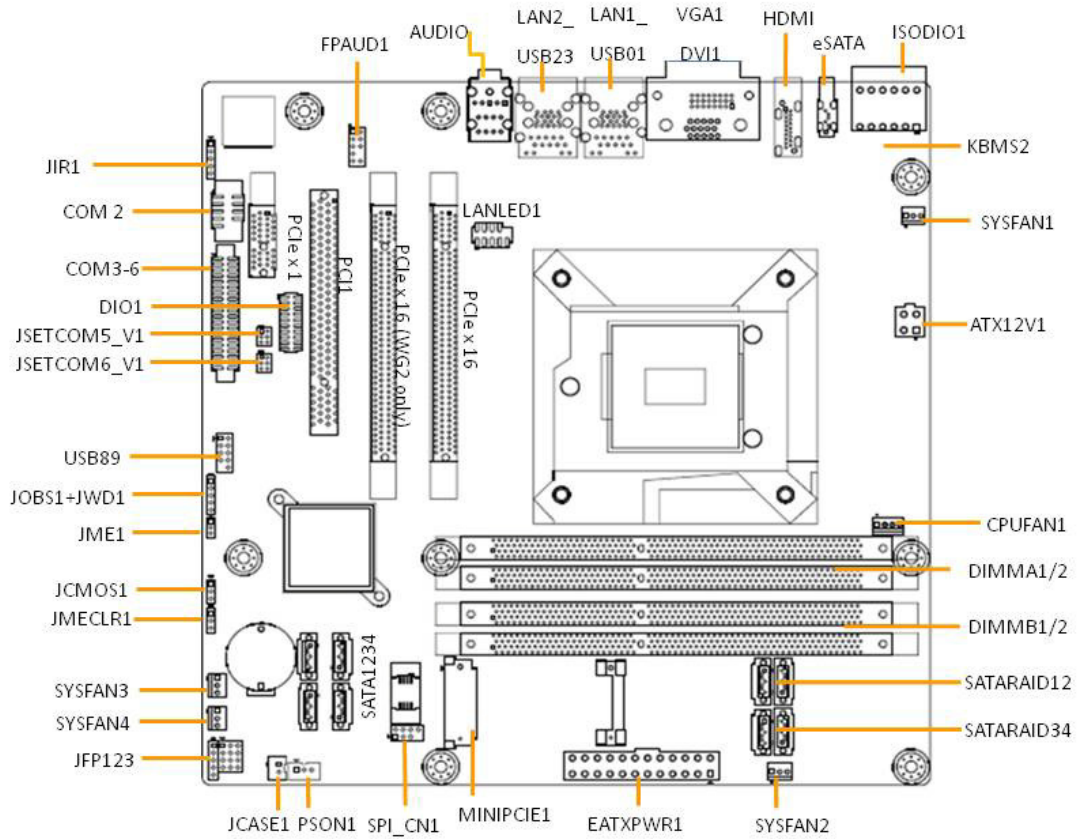

Figure 1.1 Jumper and Connector Location



Figure 1.2 I/O Connectors

1.6 AIMB-502 Board Diagram

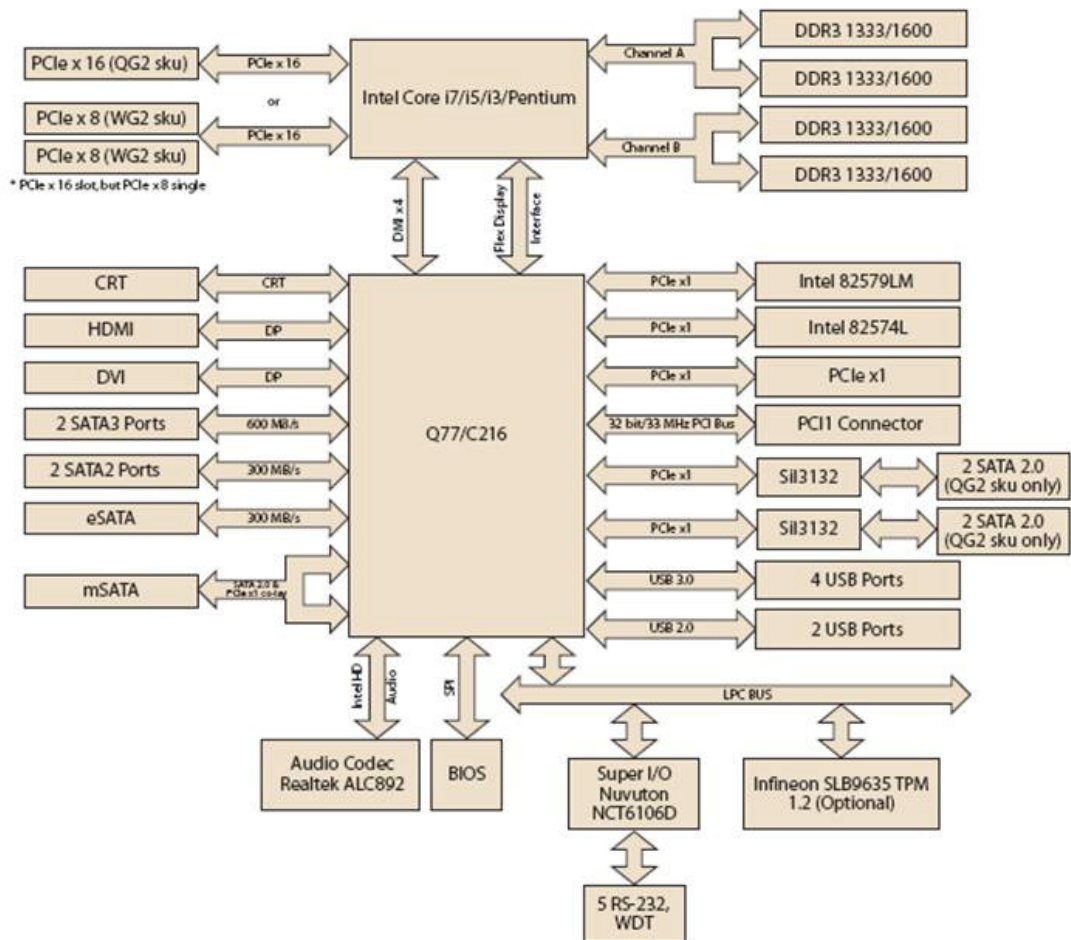

Figure 1.3 AIMB-502 Block Diagram

1.7 Safety Precautions

Warning! Always completely disconnect the power cord from chassis whenever you work with the hardware. Do not make connections while the power is on. Sensitive electronic components can be damaged by sudden power surges. Only experienced electronics personnel should open the PC chassis.



Caution! Always ground yourself to remove any static charge before touching the motherboard. Modern electronic devices are very sensitive to electrostatic discharges. As a safety precaution, use a grounding wrist strap at all times. Place all electronic components on a static-dissipative surface or in a static-shielded bag when they are not in the chassis.



Caution! The computer is provided with a battery-powered real-time clock circuit. There is a danger of explosion if battery is incorrectly replaced. Replace only with same or equivalent type recommended by the manufacturer. Discard used batteries according to manufacturer's instructions.



Caution! There is a danger of a new battery exploding if it is incorrectly installed. Do not attempt to recharge, force open, or heat the battery. Replace the battery only with the same or equivalent type recommended by the manufacturer. Discard used batteries according to the manufacturer's instructions.



1.8 Jumper Settings

This section provides instructions on how to configure your motherboard by setting the jumpers. It also includes the motherboards's default settings and your options for each jumper.



1.8.1 How to Set Jumpers

You can configure your motherboard to match the needs of your application by setting the jumpers. A jumper is a metal bridge that closes an electrical circuit. It consists of two metal pins and a small metal clip (often protected by a plastic cover) that slides over the pins to connect them. To “close” (or turn ON) a jumper, you connect the pins with the clip. To “open” (or turn OFF) a jumper, you remove the clip. Sometimes a jumper consists of a set of three pins, labeled 1, 2, and 3. In this case you connect either pins 1 and 2, or 2 and 3. A pair of needle-nose pliers may be useful when setting jumpers.

1.8.2 CMOS Clear (CMOS1)

The AIMB-502 motherboard contains a jumper that can erase CMOS data and reset the system BIOS information. Normally this jumper should be set with pins 1-2 closed. If you want to reset the CMOS data, set CMOS1 to 2-3 closed for just a few seconds, and then move the jumper back to 1-2 closed. This procedure will reset the CMOS to its default setting.

Table 1.3: CMOS1

Function	Jumper Setting
*Keep CMOS data	 1-2 closed
Clear CMOS data	 2-3 closed

* Default

1.8.3 JOBS1+JWD1: Watchdog Timer Output and OBS Alarm Option)

Table 1.4: JOB1+JWDT1

Pin	Pin Name
1	NC
2	SIO_WG#
3	SRST#
4	ERR_BEEP
5	OBS_BEEP

*Default



* Watchdog output to Reset# (2-3 short) / OSB enable(4-5 short)

1.8.4 PS0N1: ATX, AT Mode Selector

Table 1.5: PS0N1: ATX, AT Mode Selector

Closed Pins	Result
1-2	AT Mode
2-3*	ATX Mode

*Default

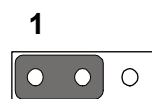

AT Mode
1-2 closed

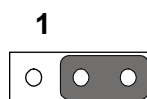

ATX Mode
2-3 closed

1.8.5 JME1:BIOS Update ME Mode Selector

JME1 is the jumper for users to select BIOS update freely without lock protection when using ADVSPI or with lock protection.

Table 1.6: BIOS update ME mode selector

Function	Jumper Setting	BIOS protect	Master Region Access Control	Update tool	ME version	ME function after update	Setting	JME1 PWR working status
1.*Production mode	(1-2) pin closed	None	FF	ADVSPI	updated	Link/remote control	default	AC on/ stdby
2.		Lock Read:0B Write:0A	ADVSPI	no updated	Link/remote control	OEM request	AC on/ stdby	
3. Manufacture mode	(2-3) pin closed	None	FF	ADVSPI	updated	None	None	None

* refers to default.

- * In default production mode, there's no lock protection for BIOS. The Master Region Access Control setting is FF, users can update the complete BIOS with the ADVSPI tool. The function is the same as manufacture mode. BIOS ME (Management Engine) function keeps link/remote control. The jumper can be set under AC off PWR status, it can not be set under standby PWR status.
- In production mode with lock protection for BIOS, the Master Region Access Control setting is Read:0B, Write:0A. Users can not update BIOS ME firmware freely. BIOS ME (Management Engine) function keeps link/remote control. This setting is only for OEM project requests. The jumper can be set under AC off PWR status, it can not set under standby PWR status.
- In manufacture mode, BIOS has no lock protection function. The Master Region Access Control setting is FF, users can update complete BIOS with ADVSPI tool. However, the BIOS ME function does not keep the link/remote control after the BIOS been updated.

1.8.6 JCASE1: Case Open Sensor

The AIMB-502 motherboard contains a jumper that provides a chassis open sensor. The buzzer on the motherboard beeps when the case is opened.

1.9 System Memory

AIMB-502 has four 240-pin memory sockets for 1333/1600 MHz memory modules with maximum capacity of 32 GB (Maximum 8 GB for each DIMM). AIMB-502QG2 supports only non-ECC DDR3 memory modules and do not support registered DIMMs (RDIMMs)

Note!  Because AIMB-502 supports Intel Active Management Technology 8.0 (iAMT 8.0) which utilizes some memory space of channel 0, it's suggested that the user should not leave channel 0 DIMM slots (DIMMA1 and DIMMA2) empty, or it may cause some system abnormality.

1.10 Memory Installation Procedures

To install DIMMs, first make sure the two handles of the DIMM socket are in the “open” position, i.e., the handles lean outward. Slowly slide the DIMM module along the plastic guides on both ends of the socket. Then firmly but gently (avoid pushing down too hard) press the DIMM module well down into the socket, until you hear a click when the two handles have automatically locked the memory module into the correct position of the DIMM socket. To remove the memory module, just push both handles outward, and the memory module will be ejected by the mechanism.

1.11 Cache Memory

The AIMB-502 supports a CPU with one of the following built-in full speed L3 caches:

8MB for Intel Xeon E3 1275v2

8MB for Intel Xeon E3 1275

8MB for Intel Xeon E3 1225v2

6MB for Intel Xeon E3 1225

8MB for Intel Core i7 3770

8MB for Intel Core i7 2600

6MB for Intel Core i5 3550S

6MB for Intel Core i5 2400

3MB for Intel Core i3 3220

3MB for Intel Core 3120

3MB for Intel Pentium G850

2MB for Intel Celeron G540

The built-in second-level cache in the processor yields much higher performance than conventional external cache memories.

1.12 Processor Installation

The AIMB-502 is designed for LGA1155, Intel Xeon and Intel Core i7/Core i5/Core i3/ Pentium/Celeron processor.

1.13 PCI Bus Routing Table

AD PCI slot INT	PCI1
	AD16
A	A
B	B
C	C
D	D

Chapter 2

Connecting
Peripherals

2.1 Introduction

You can access most of the connectors from the top of the board as it is being installed in the chassis. If you have a number of cards installed or have a packed chassis, you may need to partially remove the card to make all the connections.

2.2 LAN / USB Ports (LAN1_USB01/LAN2_USB23/USB89)

The AIMB-502 provides up to 12 USB ports. The USB interface complies with USB Specification Rev 2.0 supporting transmission rates up to 480 Mbps and Rev 3.0 supporting transmission rate up to 5 Gbps with fuse protection. The USB interface can be disabled in the system BIOS setup.

The AIMB-502 is equipped with two high-performance 1000 Mbps Ethernet LAN adapters, both of which are supported by all major network operating systems. The RJ-45 jacks on the rear panel provides convenient LAN connection.

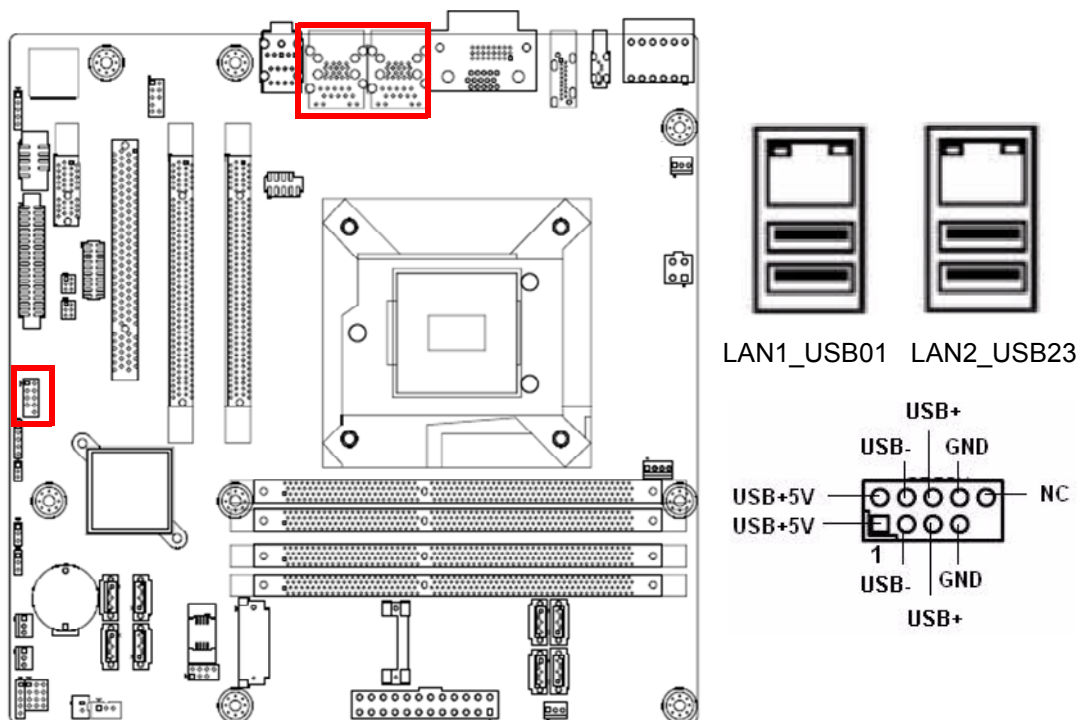
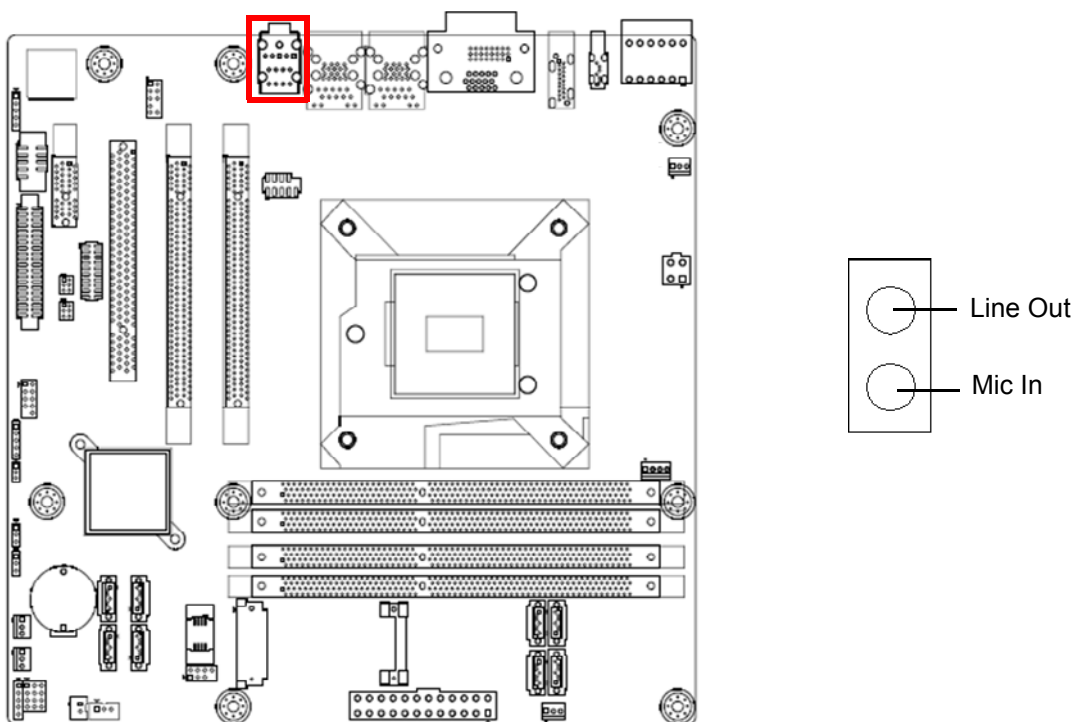

Table 2.1: LAN LED Indicator

LAN Mode	LAN Indicator	
LAN1 indicator	LED1 (Right)	off for mal-link; Link (On) / Active (Flash)
	LED2 (Left)	100 Mbps (On) / 10 Mbps (Off)
	LED2 (Left)	1000 Mbps (On)
LAN2 indicator	LED1 (Right)	off for mal-link; Link (On) / Active (Flash)
	LED2 (Left)	100 Mbps (On) / 10 Mbps (Off)
	LED2 (Left)	1000 Mbps (On)

2.3 Line Out, Mic In Connector (AUDIO1)



2.4 VGA/DVI-D Connector (VGA1+DVI 1) Connector

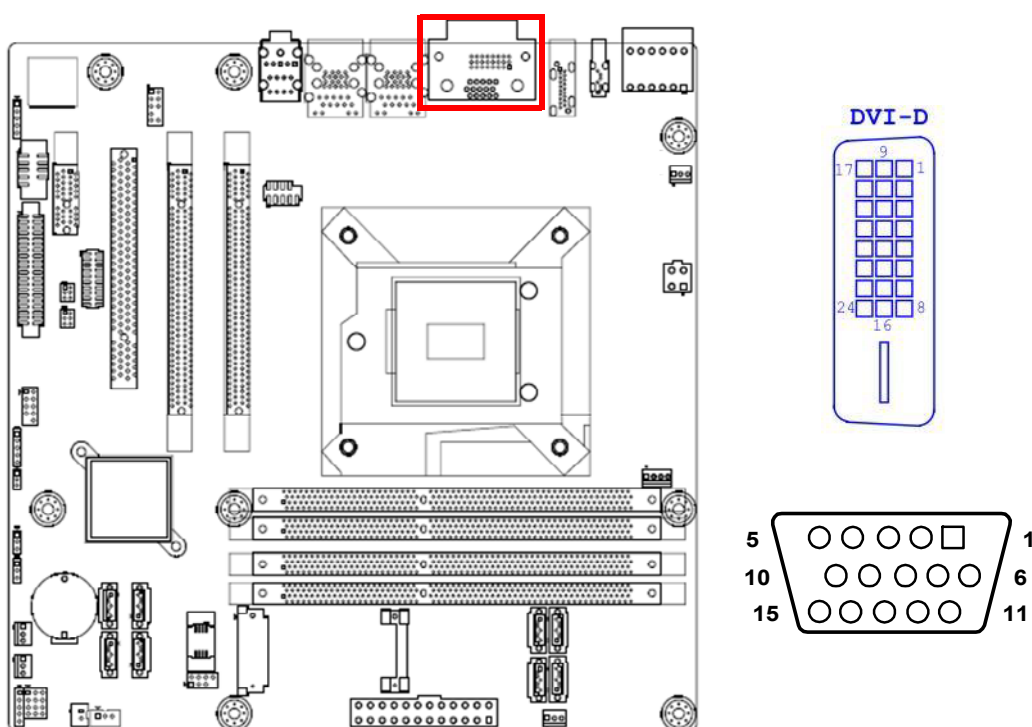

AIMB-502 includes VGA and DVI interfaces that can drive conventional VGA and DVI displays. VGA is a standard 15-pin D-SUB connector commonly used for VGA. Pin assignments for VGA and DVI connectors are detailed in Appendix B.

2.5 Serial Ports (COM1~COM6)

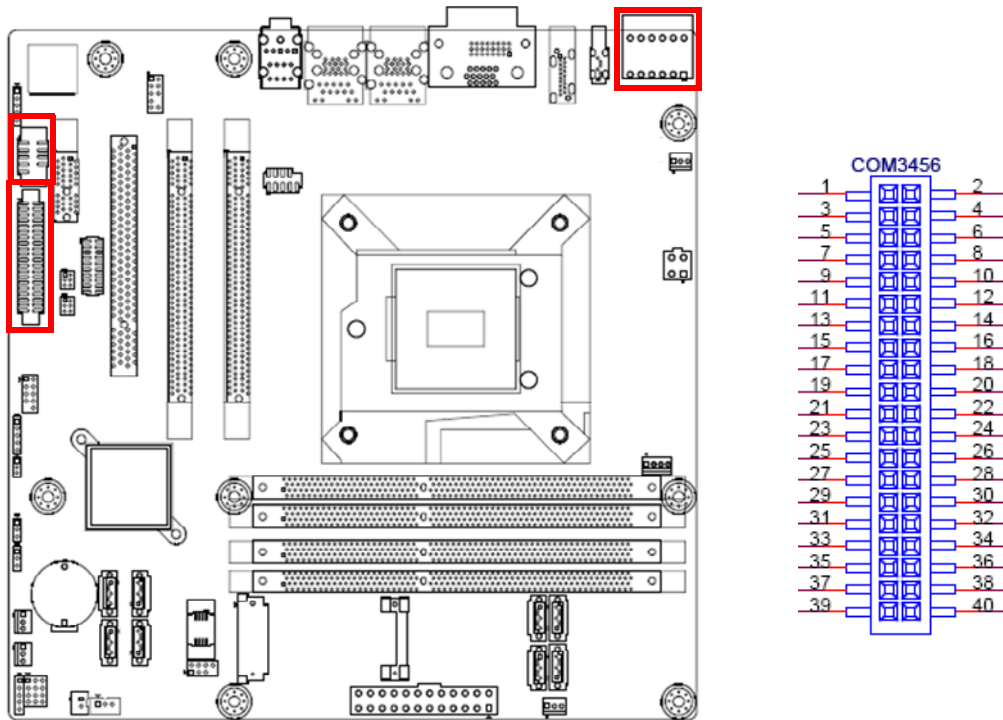

AIMB-502 supports six serial ports. COM1 supports RS-485 and 6 bit non-programmable GPIO (4 in, 2 out) and COM2 - 6 support RS-232. COM 5, 6 support 5V/12V power (JSETCOM5_V1, JSETCOM6_V1 is used to select for 5V/12V power).

These ports can connect to serial devices, such as a mouse or a printer, or to a communications network.

The IRQ and address ranges for both ports are fixed. However, if you want to disable the port or change these parameters later, you can do this in the system BIOS setup.

Different devices implement the RS-232 standards in different ways. If you have problems with a serial device, be sure to check the pin assignments for the connector.

2.6 HDMI Port

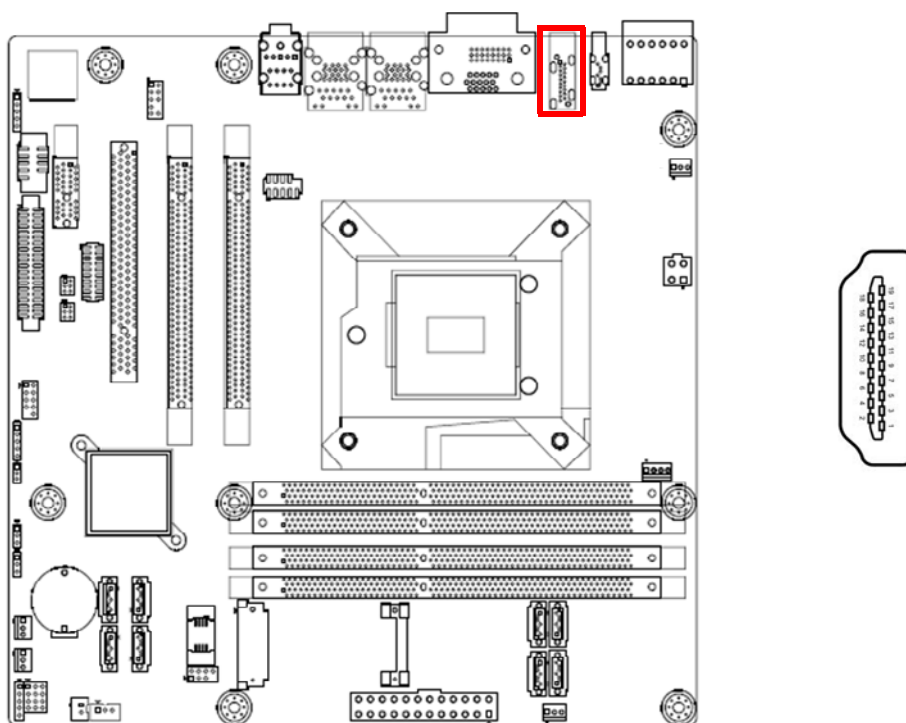

2.7 eSATA Port

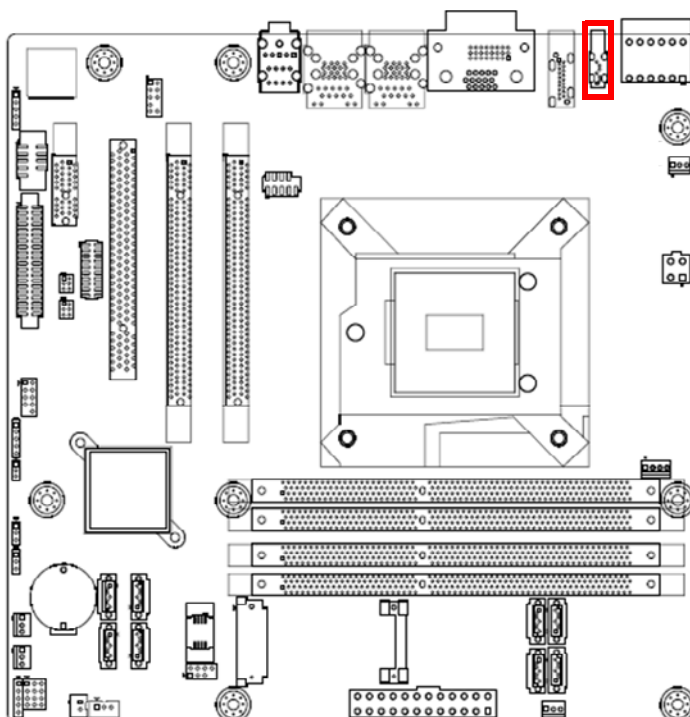

2.8 CPU Fan Connector (CPU_FAN1)

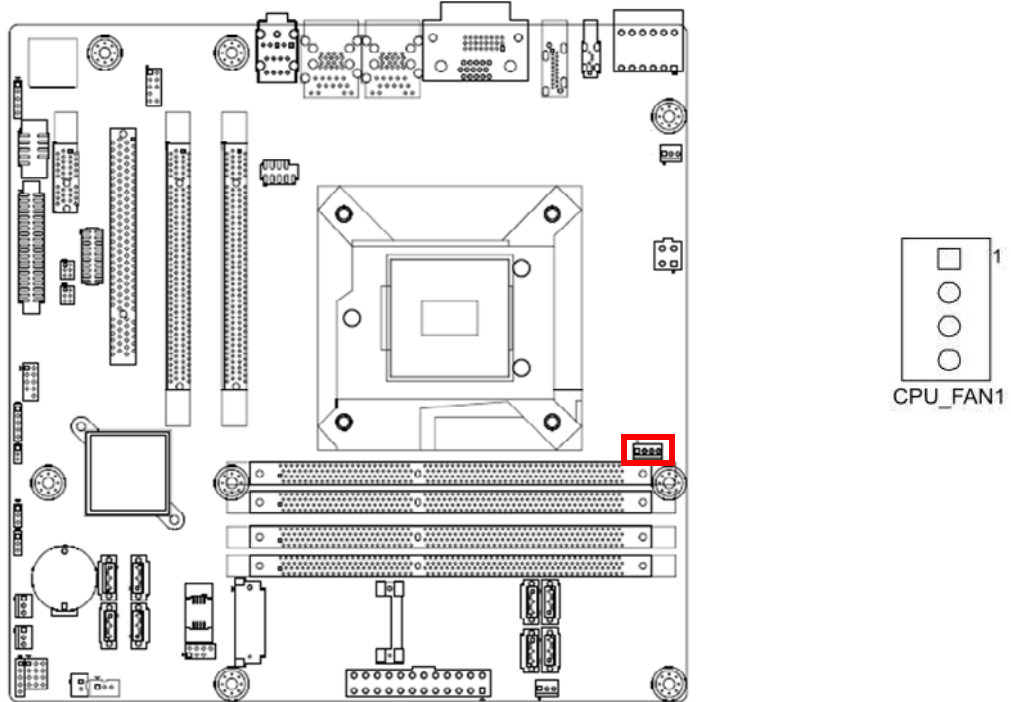

If a fan is used, this connector supports cooling fans of 500 mA (6 W) or less.

2.9 System FAN Connector (SYSFAN1/2/3/4)

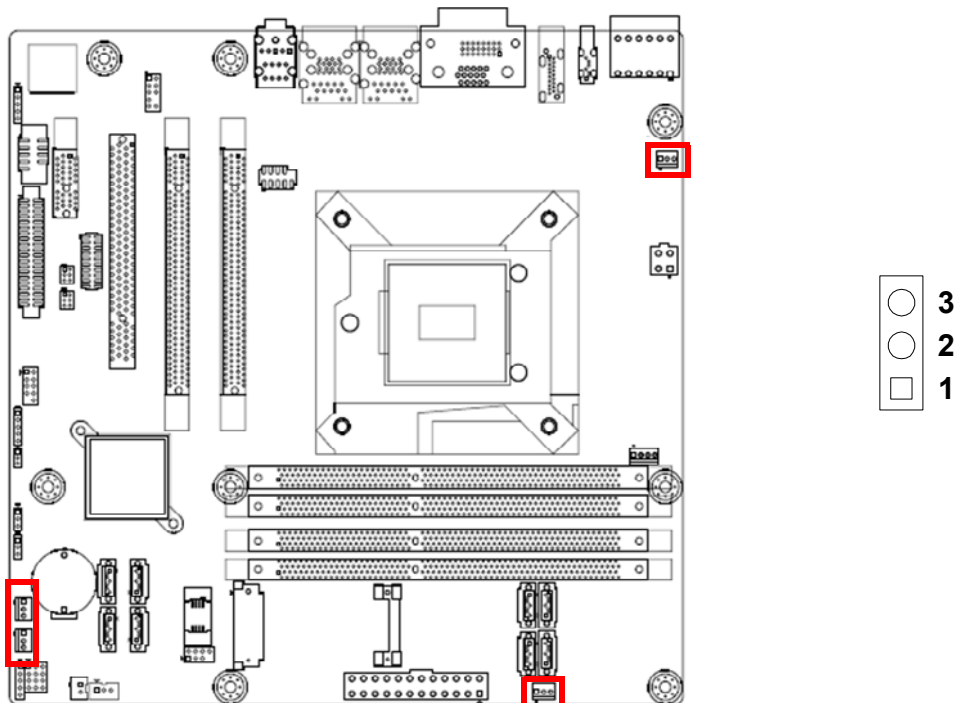

If a fan is used, this connector supports cooling fans of 500 mA (6 W) or less.

Note! Due to GPIO limitation, only 2 system fan speed could be read and showed on BIOS section; SYSFAN 1 & 2 are one pair with the same fan speed, and SYSFAN 3 & 4 are one pair with the same fan speed.



2.10 Front Panel Connectors (JFP1/JFP2/JFP3)

There are several headers for monitoring and controlling the AIMB-502.

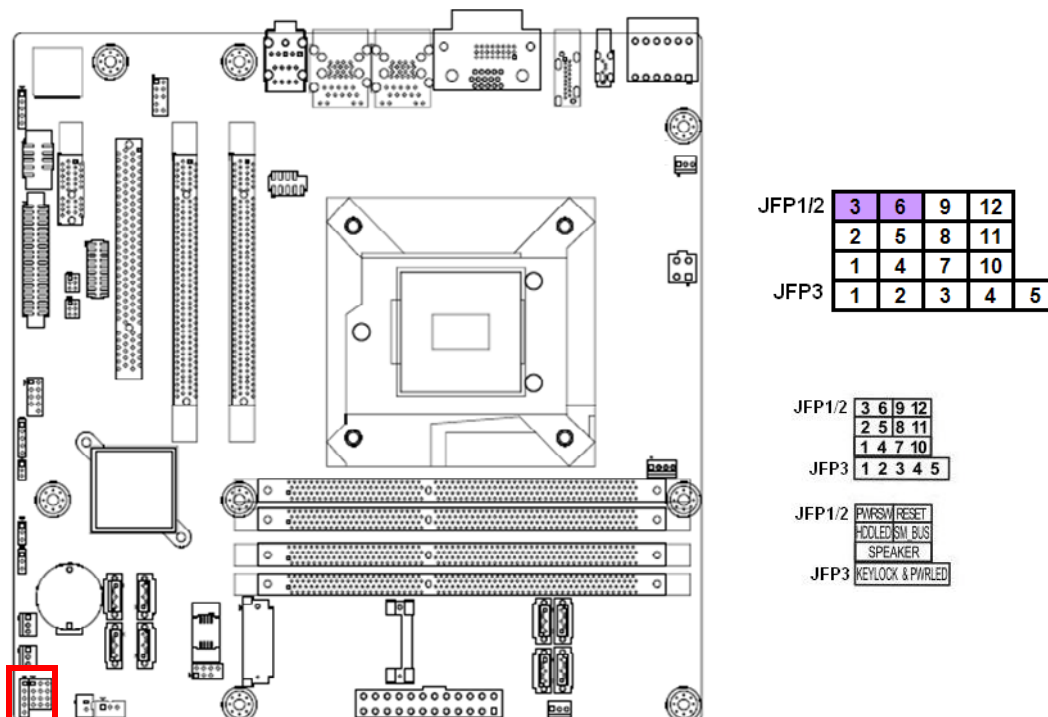

2.10.1 ATX soft power switch ((JFP1/PWR_SW))

If your computer case is equipped with an ATX power supply, you should connect the power on/off button on your computer case to ((JFP1/ PWR_SW)), for convenient power on and off.

2.10.2 Reset (JFP1/RESET)

Many computer cases offer the convenience of a reset button. Connect the wire for the reset button.

2.10.3 HDD LED (JFP1/HDDLED)

You can connect an LED to connector (JFP2/HDDLED) to indicate when the HDD is active.

2.10.4 External speaker (JFP1/SPEAKER)

JFP1/SPEAKER is a 4-pin connector for an external speaker. If there is no external speaker, the AIMB-502 provides an onboard buzzer as an alternative. To enable the buzzer, set pins 7 & 10 as closed.

2.10.5 Power LED and keyboard lock connector (JFP3/PWR_LED & KEY LOCK)

(JFP3/PWR_LED & KEY LOCK) is a 5-pin connector for the power on LED and Key Lock function. Refer to Appendix B for detailed information on the pin assignments. The Power LED cable should be connected to pin 1-3. The key lock button cable should be connected to pin 4-5. There are 3 modes for the power supply connection. The first is “ATX power mode”; the system turns on/off by a momentary power button. The second is “AT Power Mode”; the system turns on/off via the power supply switch. The third is another “AT Power Mode” which makes use of the front panel power switch. The power LED status is indicated in the following table:

Table 2.2: ATX power supply LED status (No support for AT power)

Power mode	LED (ATX Power Mode) (On/off by momentary button)	LED (AT power Mode) (On/off by switching power supply)	LED (AT power Mode) (On/off by front panel switch)
PSON1 (on back plane) jumper setting	pins 2-3 closed	pins 1-2 closed	Connect pins 1 & 2 to panel switch via cable
System On	On	On	On
System Suspend	Fast flashes	Fast flashes	Fast flashes
System Off	Slow flashes	Off	Off

2.11 Mini PCIe & mSATA Slot

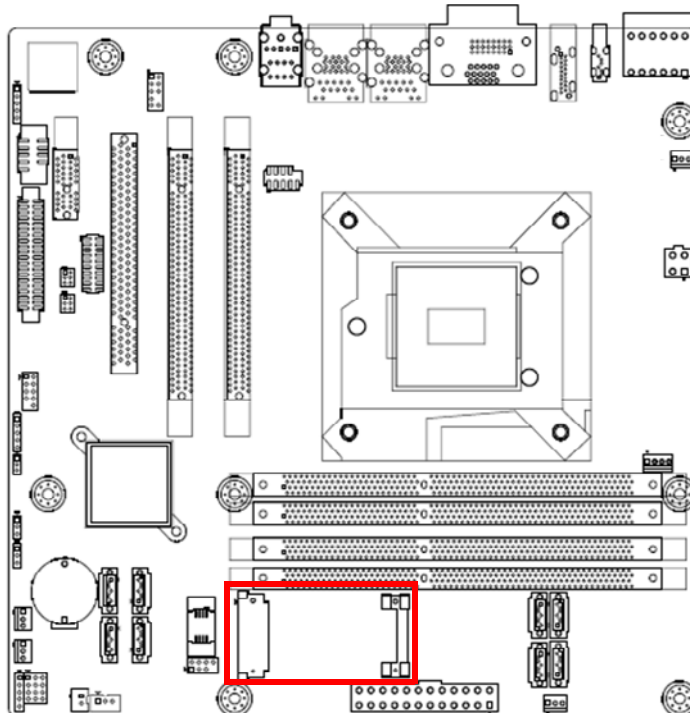

2.12 Serial ATA Interface (SATARAID1 ~ SATARAID4)

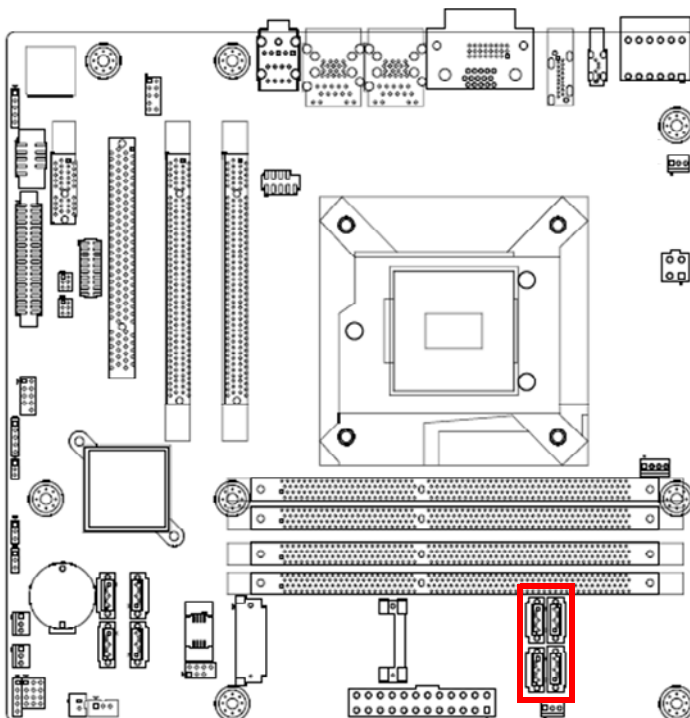

2.13 Serial ATA Interface (SATA1 ~ SATA4)

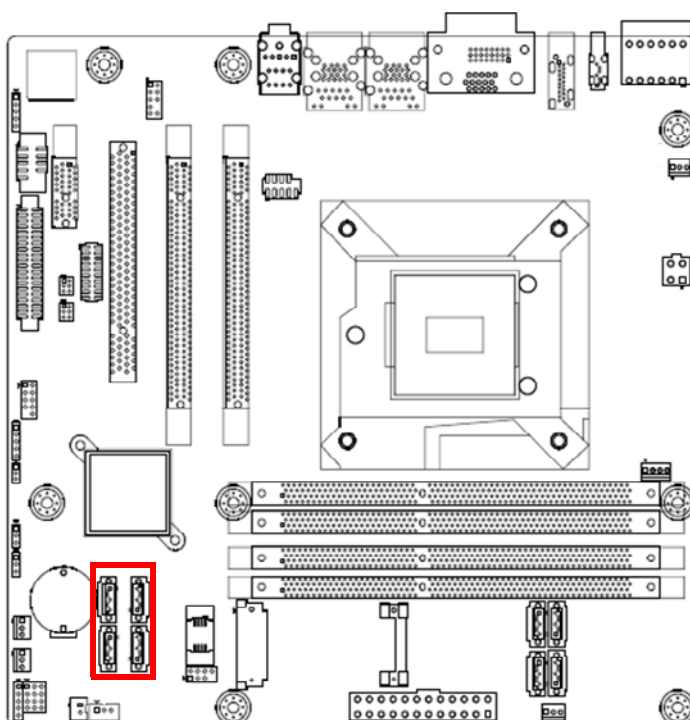

AIMB-502 features a high performance Serial ATA interface (up to 300 MB/s) and Serial ATA III interface (up to 600 MB/s) which eases hard drive cabling with thin, space-saving cables.

Note! AIMB-502 on board SATA only supports Fedora 14 and 15 and SATA mode in BIOS should be set as AHCI mode.



If SATA mode is set as IDE mode, when user is installing Fedora 14 and 15, ODD has been connected on SATA port 3~6.

2.14 Digital IO connector (DIO1)

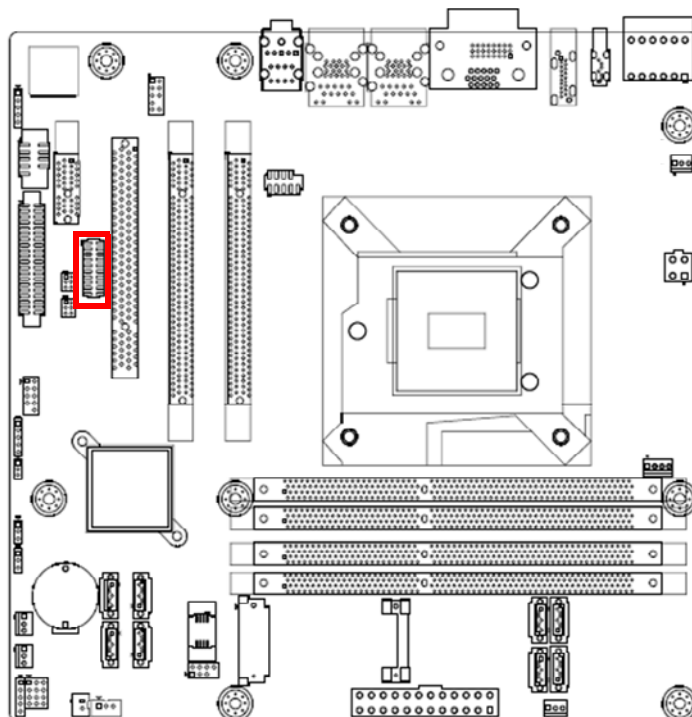

2.15 PCI Express x16 Slot (QG2: 1 slot/WG2: 2 slots)

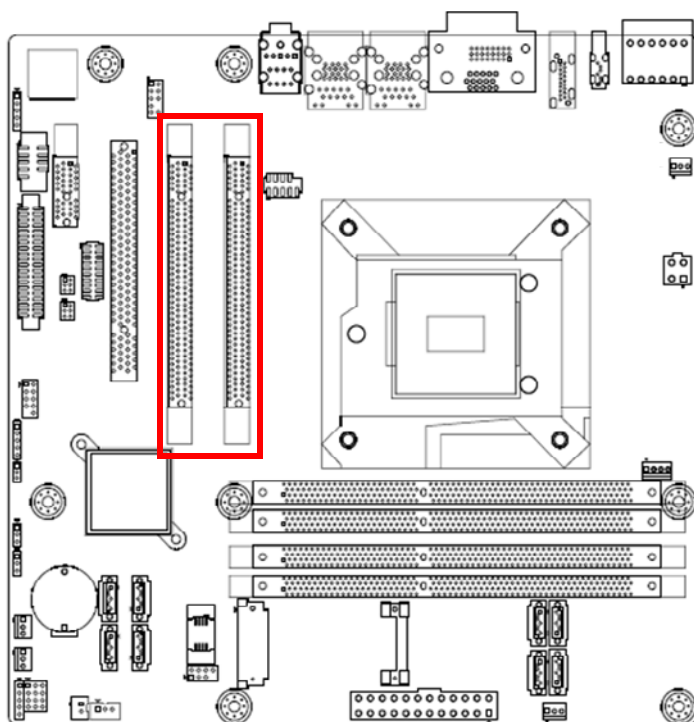

AIMB-502 provides 1 x PCIe x16 slot (QG2 sku) or 2 x PCIe x16 slots with PCIe x8 signal (WG2 sku) support Gen3 speed slot for users to install add-on cards when their applications require higher graphic performance than the CPU embedded graphics controller can provide.

2.16 Front Panel Audio Connector (FPAUD1)

This connector is for a chassis-mounted front panel audio I/O module that supports either HD Audio or legacy AC'97 (optional) audio standard. Connect this connector with the front panel audio I/O module cable.

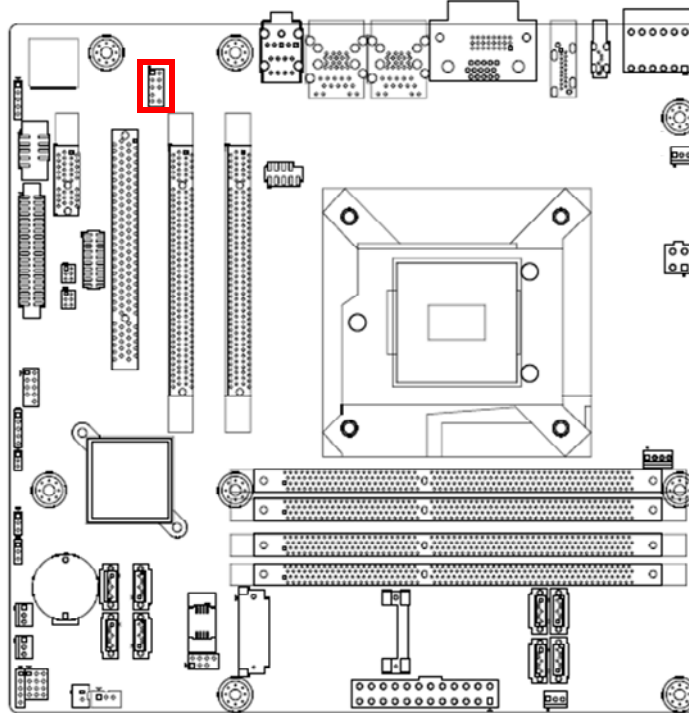

Note! For motherboards with the optional HD Audio feature, we recommend that you connect a high-definition front panel audio module to this connector to take advantage of the motherboard's high definition audio capability.



2.17 ATX Power Connector (EATXPWR1, ATX12V1)

This connector is for an ATX Micro-Fit power supply. The plugs from the power supply are designed to fit these connectors in only one direction. Determine the proper orientation and push down firmly until the connectors mate completely.

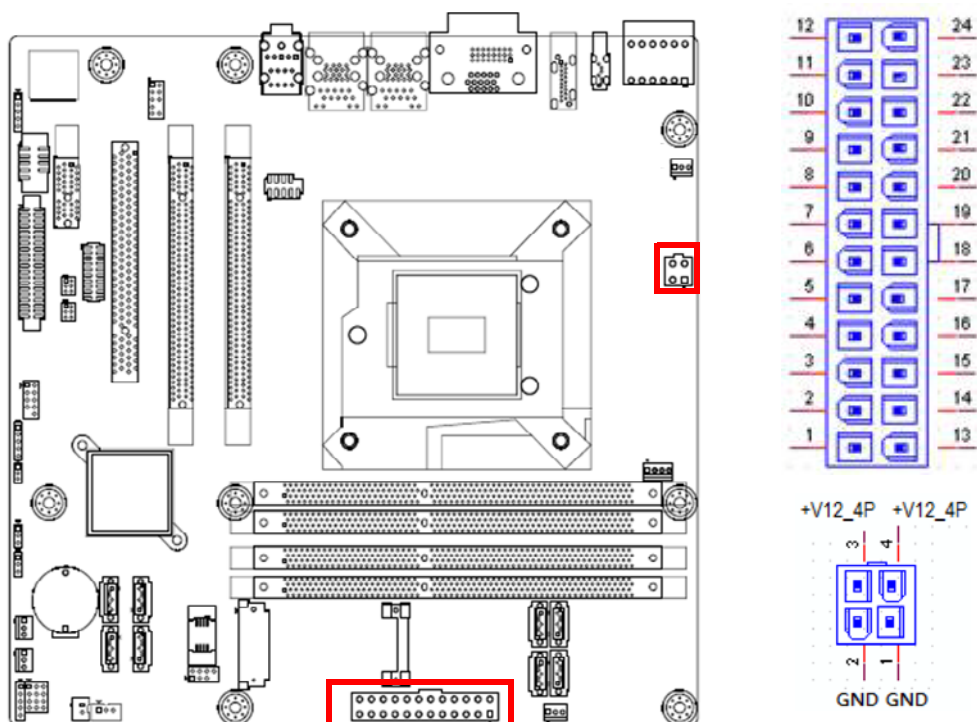

- Note!**
1. Please connect the ATX12V1 connector with the PSU ATX 12V 4-pin connector.
 2. For a fully configured system, we recommend that you use a power supply unit (PSU) that complies with ATX 12 V Specification 2.0 (or later version) and provides a minimum power of 180 W.



2.18 SPI Flash connector(SPI_CN1)

The SPI flash card pin header may be used to flash the BIOS if the AIMB-502 cannot power on.

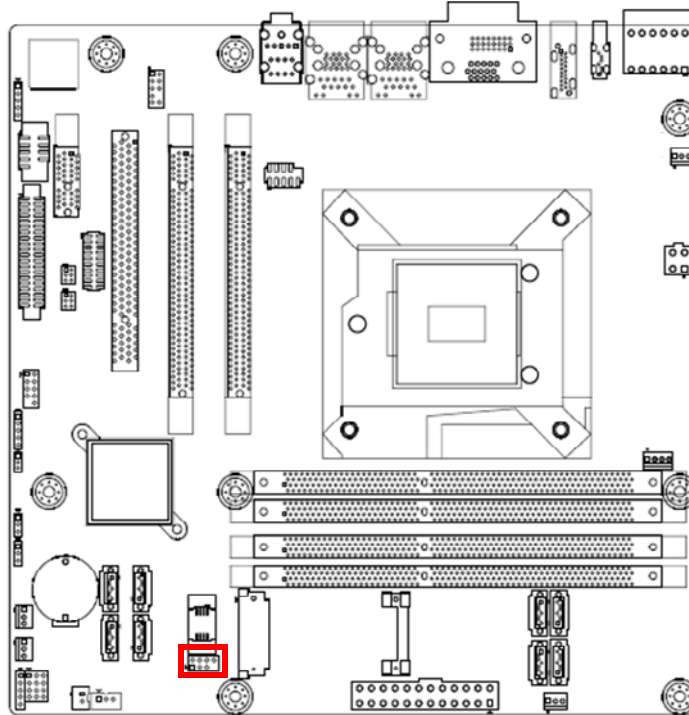

Chapter 3

BIOS Operation

3.1 Introduction

AMI BIOS has been integrated into many motherboards, and has been very popular for over a decade.

With the AMI BIOS Setup program, you can modify BIOS settings to control the special features of your computer. The Setup program uses a number of menus for making changes. This chapter describes the basic navigation of the AIMB-502 setup screens.

3.2 BIOS Setup

The AIMB-502 Series system has AMI BIOS built in, with a SETUP utility that allows users to configure required settings or to activate certain system features.

The SETUP saves the configuration in the FLASH of the motherboard. When the power is turned off, the battery on the board supplies the necessary power to preserve the FLASH.

When the power is turned on, press the button during the BIOS POST (Power-On Self Test) to access the CMOS SETUP screen.

Control Keys

< ← >< → >	Select Screen
< ↑ >< ↓ >	Select Item
<Enter>	Select
<+/->	Value
<F1>	General help
<F2>	Previous Values
<F3>	Optimized Defaults
<F4>	Save & Exit
<ESC>	Exit

3.3 Main Menu

Press or <F2> to enter AMI BIOS CMOS Setup Utility, the Main Menu will appear on the screen. Use arrow keys to select among the items and press <Enter> to accept or enter the sub-menu.



The Main BIOS setup screen has two main frames. The left frame displays all the options that can be configured. Grayed-out options cannot be configured; options in blue can. The right frame displays the key legend.

Above the key legend is an area reserved for a text message. When an option is selected in the left frame, it is highlighted in white. Often a text message will accompany it.

- **System Date / System Time**

Use this option to change the system time and date. Highlight System Time or System Date using the <Arrow> keys. Enter new values through the keyboard. Press the <Tab> key or the <Arrow> keys to move between fields. The date must be entered in MM/DD/YY format. The time must be entered in HH:MM:SS format.

3.4 Advanced BIOS Features

Select the Advanced tab from the AIMB-502 setup screen to enter the Advanced BIOS Setup screen. You can select any of the items in the left frame of the screen, such as CPU Configuration, to go to the sub menu for that item. You can display an Advanced BIOS Setup option by highlighting it using the <Arrow> keys. All Advanced BIOS Setup options are described in this section. The Advanced BIOS Setup screen is shown below. The sub menus are described on the following pages.

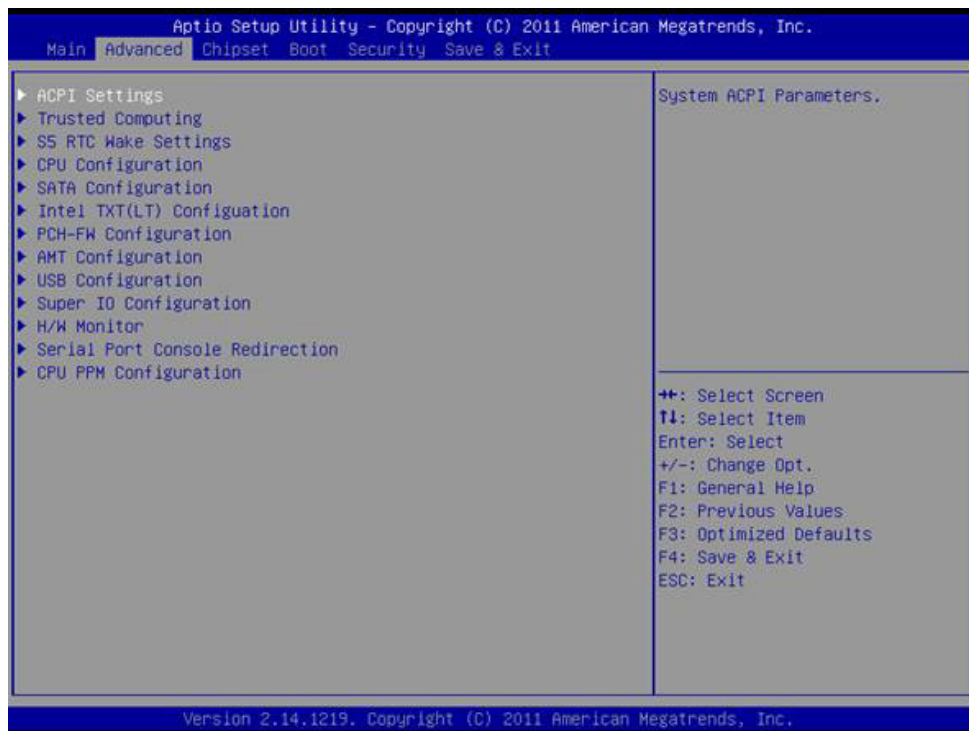

3.4.1 ACPI Settings

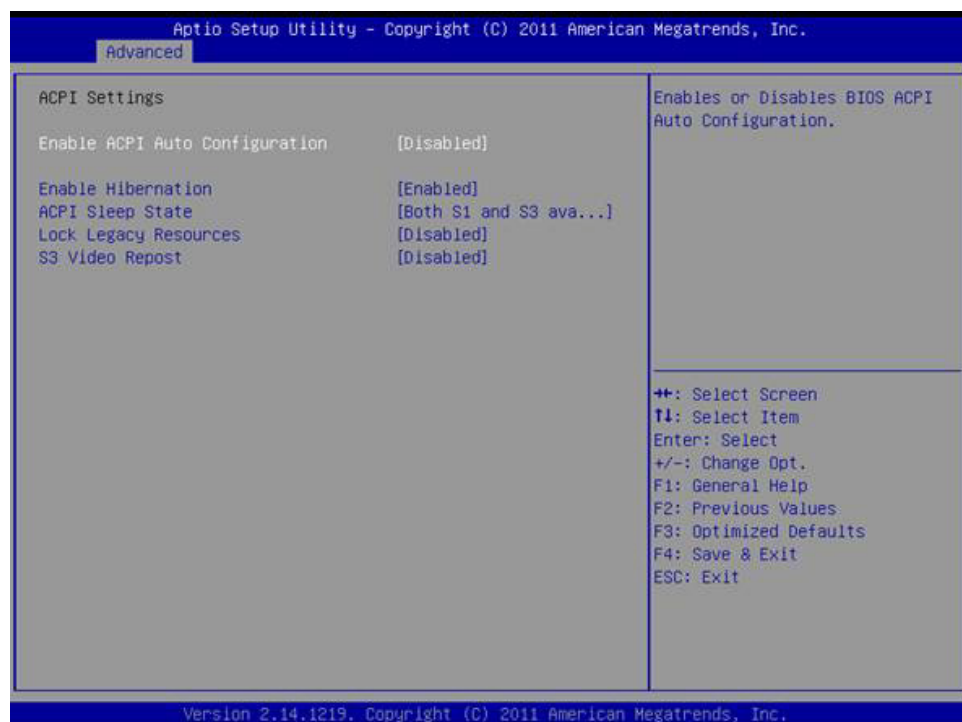

- **Enable ACPI Auto Configuration [Disabled]**
Enable or disable BIOS ACPI auto configuration.
- **Enable Hibernation [Enabled]**
- **ACPI Sleep State [Both S1 and S3 available]**
- **Lock Legacy Resources [Disabled]**
- **S3 Video Repost [Disabled]**

3.4.2 Trusted Computing:

To enable/disable TPM (TPM 1.1/1.2) set up in BIOS. TPM (Trusted Platform Module) is a secure key generator and key cache management component, enables protected storage of encryption keys and authentication credentials for enhanced security capabilities.

Note! The following items function only when a TPM IC is populated on board.



- **Security Device Support [Disable]**

3.4.3 S5 RTC Wake Settings

The item allows you enable or disable system wake up on alarm event.



- Wake system with Fixed Time [Disabled]

3.4.4 CPU Configuration

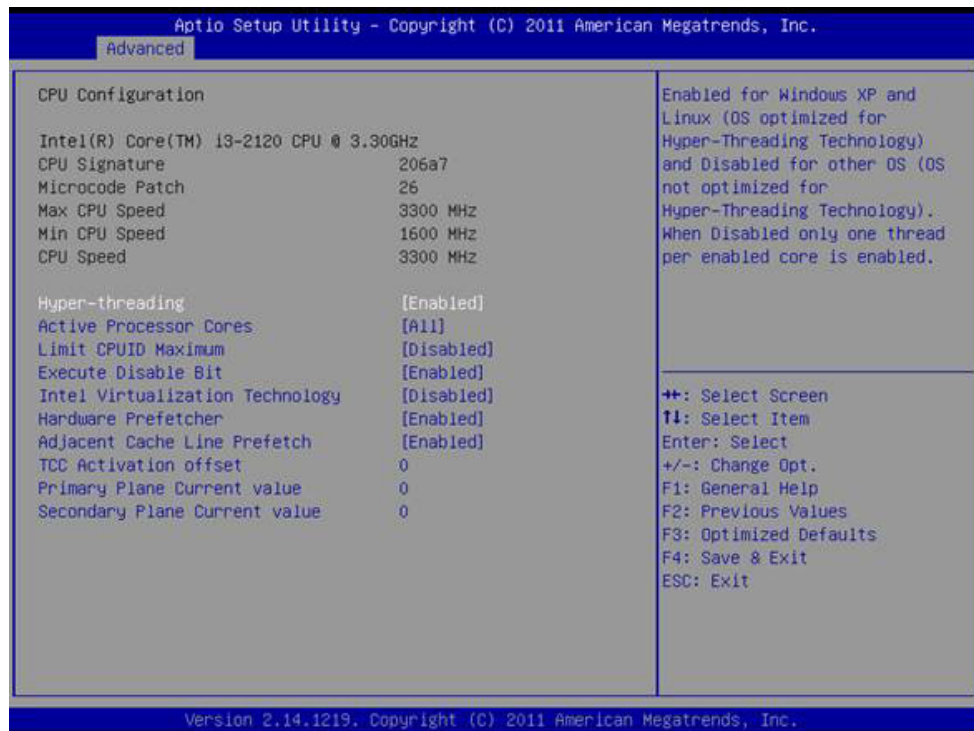

- **Hyper-threading [Enabled]**
Enabled for Windows XP and Linux (OS optimized for Hyper-Threading Technology) and Disable for other OS which are not optimized for HT Technology. When disabled, only one thread per core is enabled.
- **Active Processor Cores [All]**
Allows you to choose the number of CPU cores to activate in each processor package.
- **Limit CPUID Maximum [Disabled]**
This item allows you to limit CPUID maximum value.
[Enabled] Allow legacy operating systems to boot even without support for CPUs with extended CPUID functions.
- **Execute Disable Bit [Enabled]**
This item allows you to enable or disable the No-Execution page protection technology.
- **Intel Virtualization Technology [Disabled]**
Intel Virtualization Technology (Intel VT) is a set of hardware enhancements to Intel server and client platforms that provide software-based virtualization solutions.
Intel VT allows a platform to run multiple operating systems and applications in independent partitions, allowing one computer system to function as multiple virtual systems.
- **Hardware Prefetch [Enabled]**
The processor fetches data and instructions from the memory into the cache that is likely to be required in the near future. This reduces the latency associated with memory reads.
- **Adjacent Cache Line Prefetch [Enabled]**
This item allows users to enable or disable the adjacent cache line prefetch feature.

3.4.5 SATA Configuration

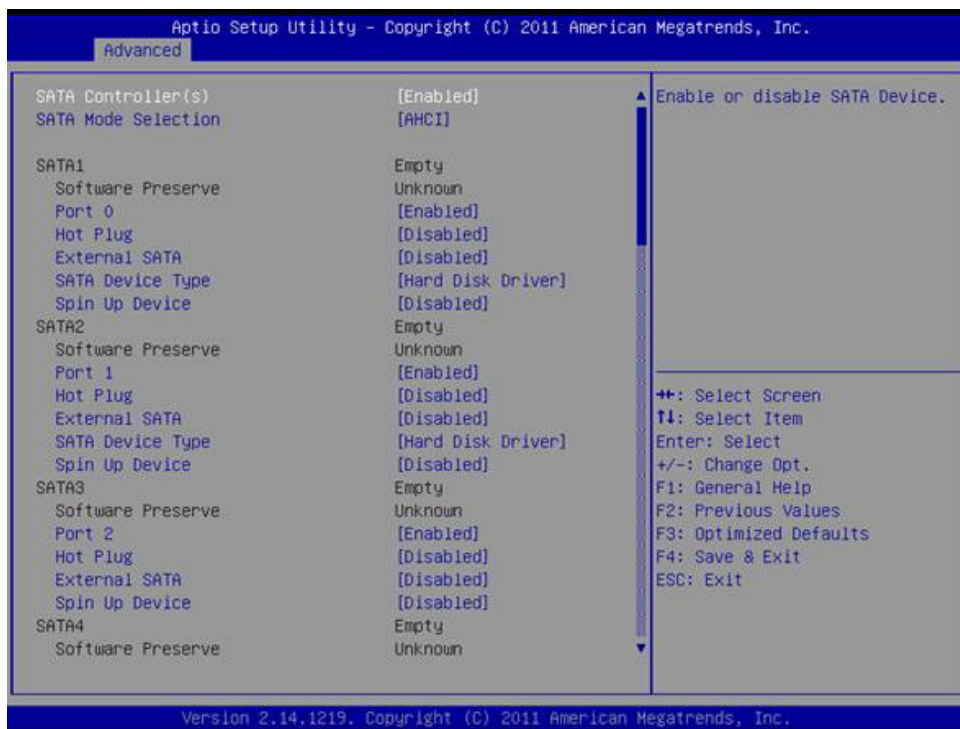

- **SATA Controllers [Enabled]**
Enable or disable SATA Function.
- **SATA Mode [AHCI]**
This can be configured as IDE or AHCI mode.

Note! *There are total 10 SATA devices on AIMB-502, but only 6 SATA devices that appear in the BIOS section (SATA1~4, eSATA, and mSATA). The rest of the 4 SATA devices (SATARAID1~4) can work properly still, even if they don't all appear in BIOS section though.*



Note! *There are no HW RAID ROM options for SATA RAID1~4, so then customer can configure all SATA devices by programming the SW RAID function under Window & Linux OS.*



Note! *SATA RAID1~4 can't be configured as boot up devices.*



3.4.6 Intel TXT (LT) Configuration

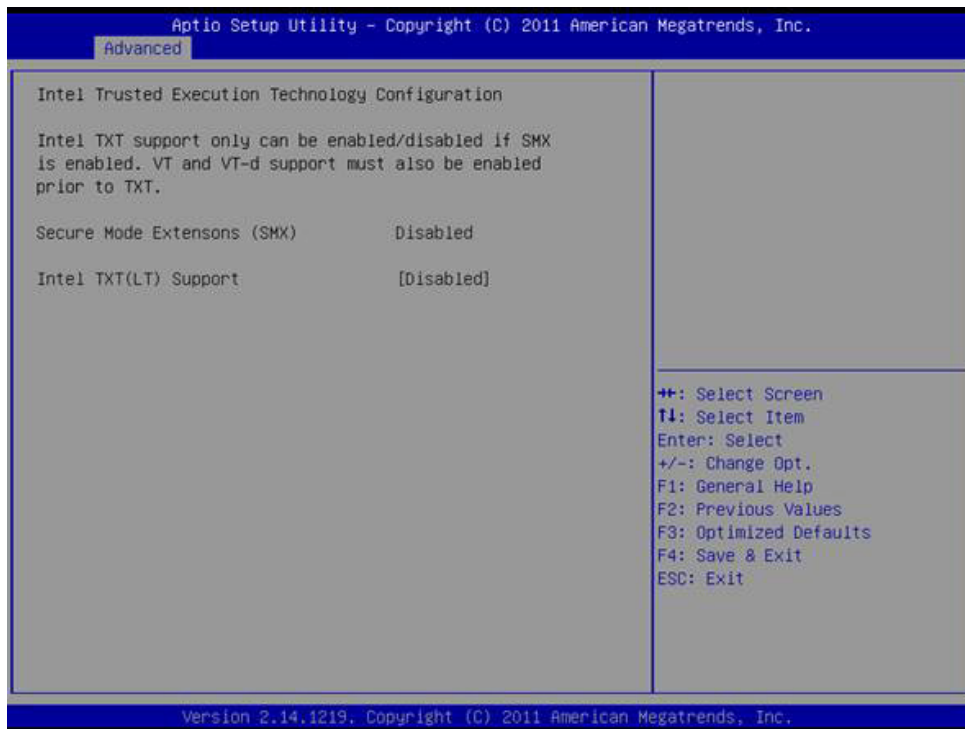

- **Secure Mode Extension (SMX) [Disabled]**
This item allows you to enable or disable the Intel Secure Mode Extensions (SMX) technology.
- **Intel TXT Configuration [Disabled]**
Intel TXT support could be enabled/ disabled only when SMX is enabled. Intel VT and VT-d support must be enabled prior to TXT, also.

3.4.7 PCH-FW Configuration



- **MEDS BISO Status Code [Disabled]**
This item allows you to enable or disable MDES BIOS Status Code.

3.4.8 AMT Configuration



- **Intel AMT [Enabled]**

This item allows users to enable or disable Intel AMT BIOS extension. This option just controls BIOS extension execution. If enabled, it requires additional firmware in the SPI device.

Note! iAMT H/W is always enabled.



- **BIOS Hotkey Pressed [Disabled]**
- **MEBx Select Screen [Disabled]**
- **Hide Un-Configure ME Confirmation [Disabled]**
- **MEBx Debug Message Output [Disabled]**
- **Un-Configure ME [Disabled]**
- **Amt Wait timer [0]**
- **Disable ME [Disabled]**
- **ASF [Enabled]**
- **Active Remote Assistance Process [Disabled]**
- **USB Configure [Enable]**
- **PET Progress [Enable]**
- **AMT CIRA Timeout [0]**
- **Watchdog [Disabled]**

When set to [Enabled], the Watchdog timer will monitor the time taken for each task performed by a software or hardware.

OS Timer [0]

BIOS Timer [0]

3.4.9 USB Configuration

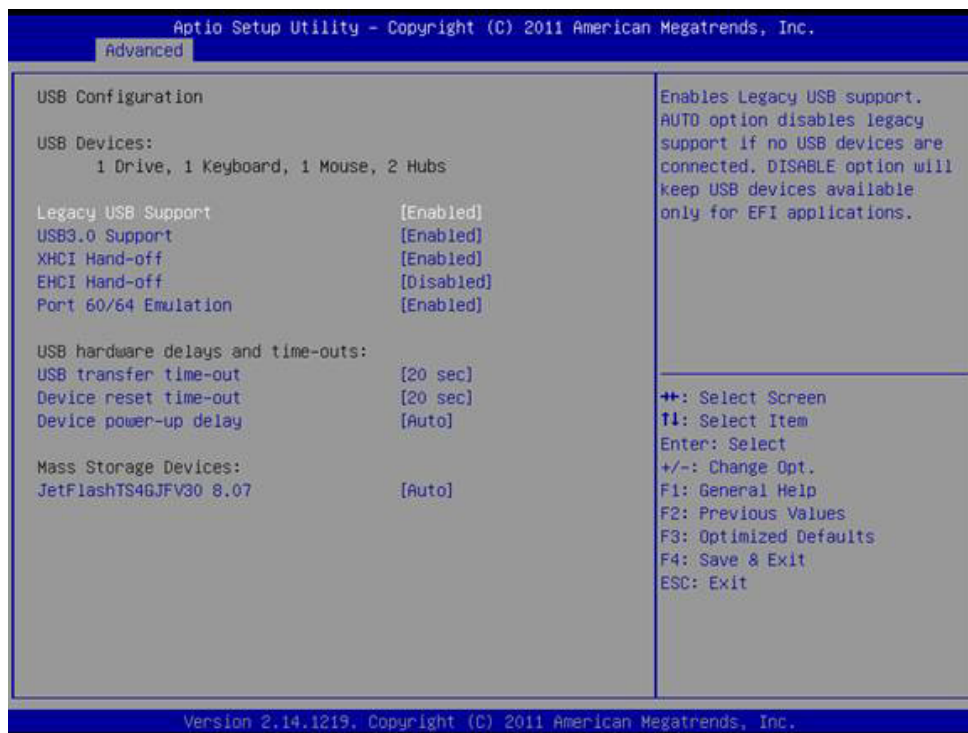

- **USB Device**
- **Legacy USB Support [Enabled]**
Enables legacy USB supported. Auto option disables legacy support if no USB devices are connected.
Disable option will keep USB devices available only for EFI applications.
- **USB 3.0 Support [Enabled]**
- **XHCI Hand-off [Enabled]**
- **EHCI Hand-off [Disabled]**
- **Port 60/64 Emulation [Enabled]**
This is just a workaround item under OS without EHCI hand-off support.
- **USB Hardware delays and time-outs (default):**
- **USB transfer time-out [20 sec]**
- **Device reset time-out [20 sec]**
- **Device power-up delay [Auto]**
USB mass storage device reset time out.
- **Mass Storage Devices [Auto]**
Shows USB storage device information.

3.4.10 Super IO Configuration



Super IO Chip NCT6106D



Serial Port 1 Configuration

- Serial Port [Enabled]
- Device Setting IO=3F8h; IRQ=4
- Change Settings [Auto]

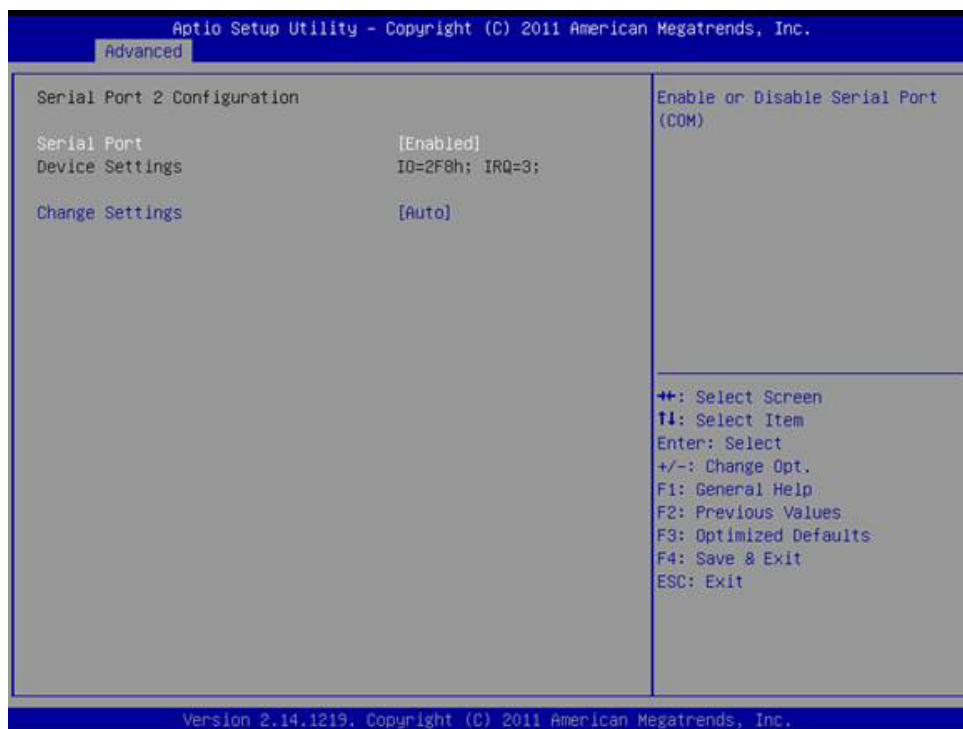

Serial Port 2 Configuration

- Serial Port [Enabled]
- Device Setting IO=2F8h; IRQ=3
- Change Settings [Auto]

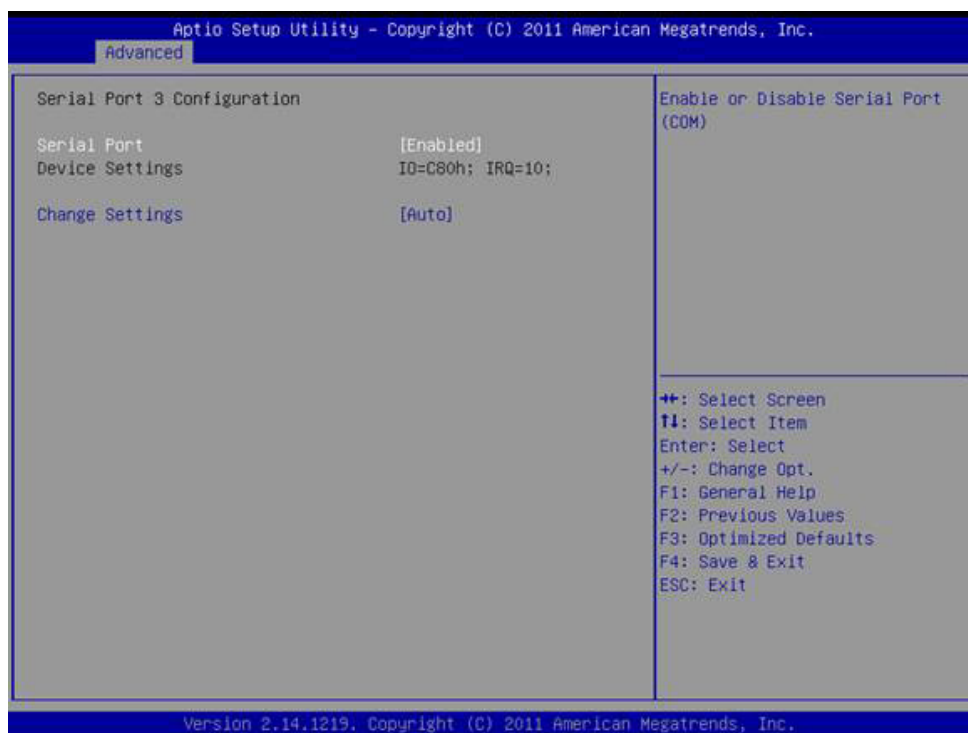

Serial Port 3 Configuration

- Serial Port [Enabled]
- Device Setting IO=C80h; IRQ=10
- Change Settings [Auto]

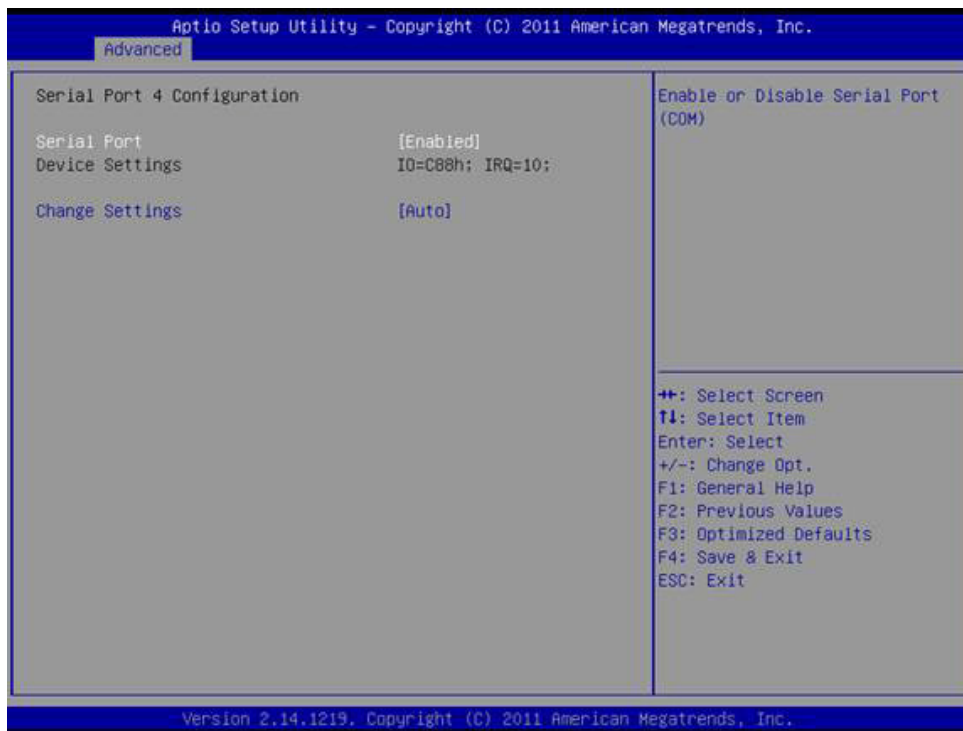

Serial Port 4 Configuration

- Serial Port [Enabled]
- Device Setting IO=C88h; IRQ=10
- Change Settings [Auto]

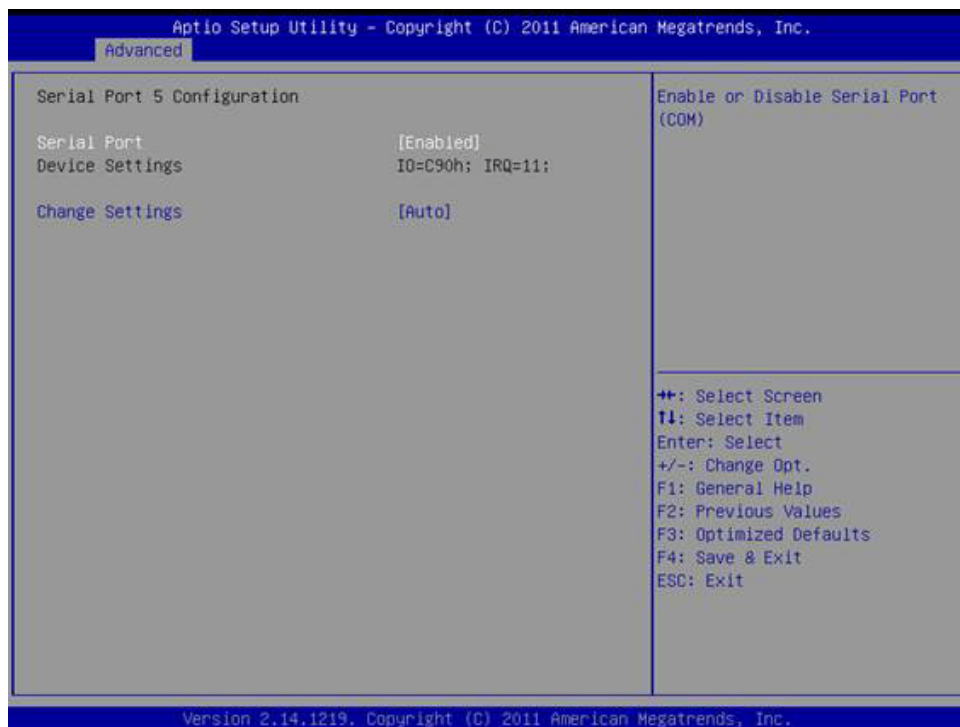

Serial Port 5 Configuration

- Serial Port [Enabled]
- Device Setting IO=C90h; IRQ=11
- Change Settings [Auto]



Serial Port 6 Configuration

- Serial Port [Enabled]
- Device Setting IO=C98h; IRQ=11
- Change Settings [Auto]

Digital I/O Configuration

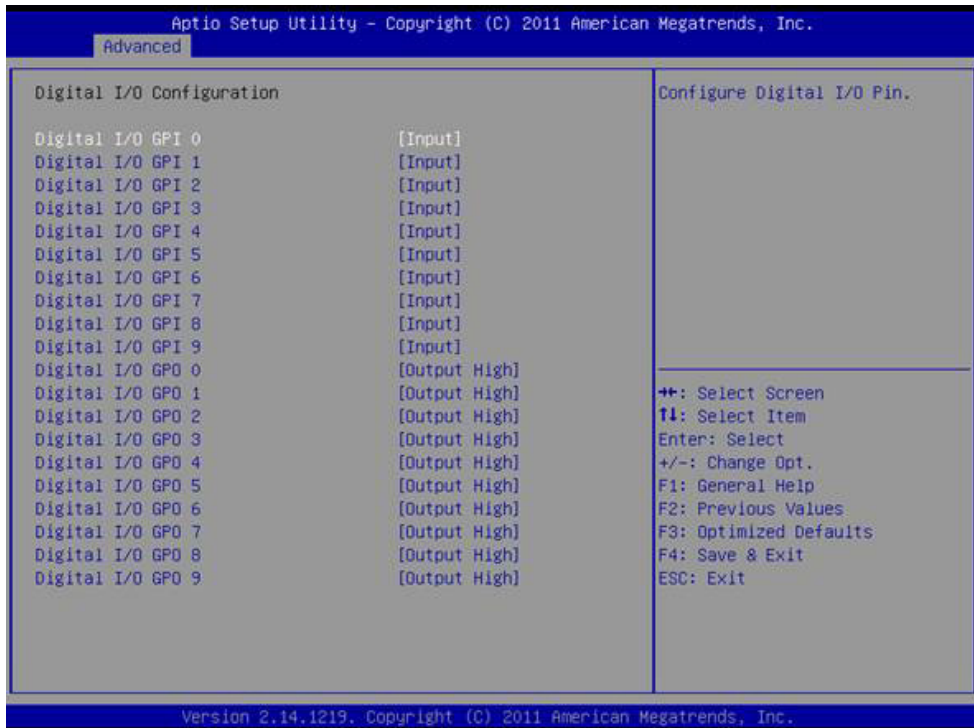

3.4.11 H/W Monitor

You can monitor the system temperature, CPU temperature, CPU fan speed and voltage status from this section, And also setting the warning temperature and shut-down temperature here.

PC Health Status

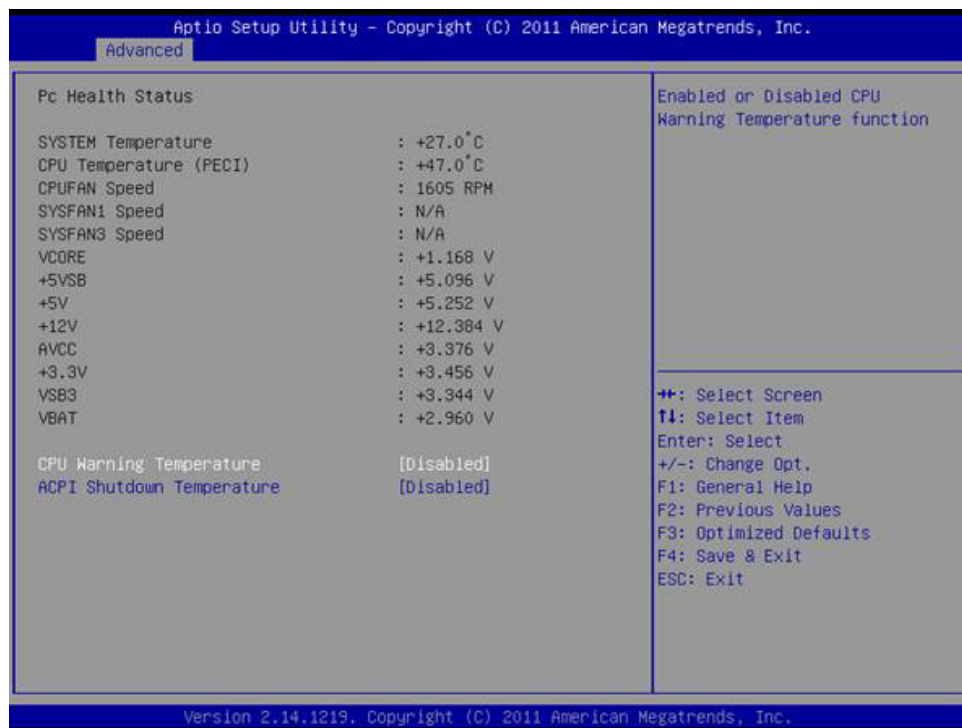

- **System Temperature**
- **CPU Temperature (PECI)**
CPU Temperature shown here is CPU T-junction temperature via PECI.
- **CPUFAN Speed**
- **CPU Warning Temperature [Disabled]**
Use this to set the CPU warning temperature threshold. When the system reaches the warning temperature, the speaker will beep.
- **ACPI Shutdown Temperature [Disabled]**
Use this to set the ACPI shutdown temperature threshold. When the system reaches the shutdown temperature, it will be automatically shut down by ACPI OS to protect the system from overheating damage.

Smart Fan Mode Configuration

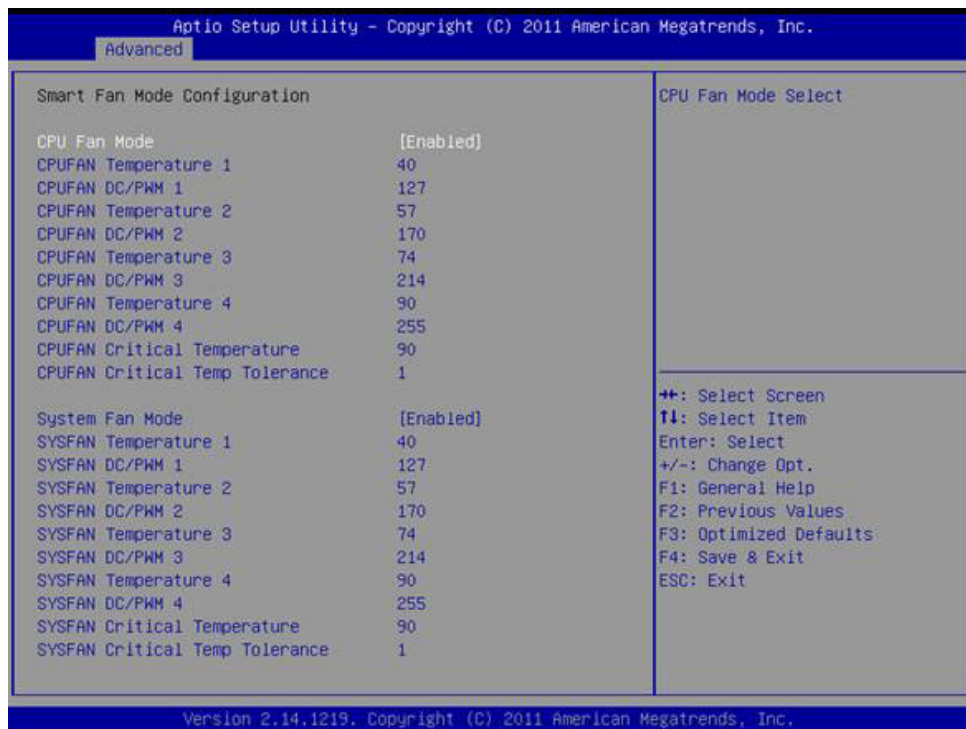

- **CPUFAN Mode Setting [Enabled]**
“Enable or Disable” smart fan select for CPU fan.
- **SYSFAN Mode Setting [Enabled]**
“Enable or Disable” smart fan select for system fan.

3.4.12 Serial Port Console Redirection

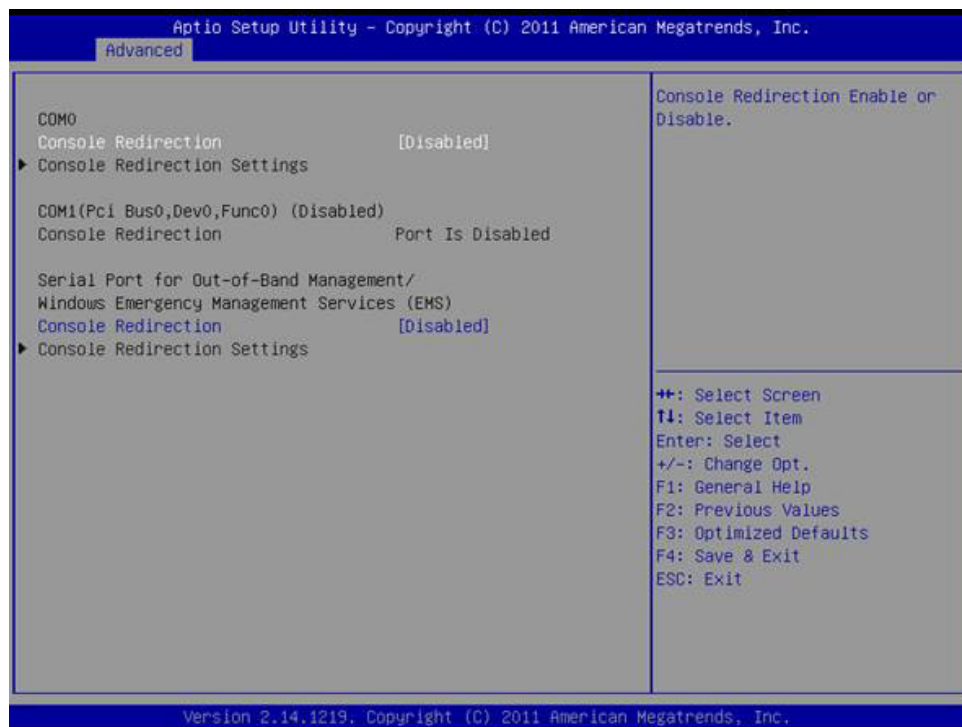

- **Console Redirection [Disabled]**
Enable or disable the console redirection feature.

3.4.13 CPU PPM Configuration

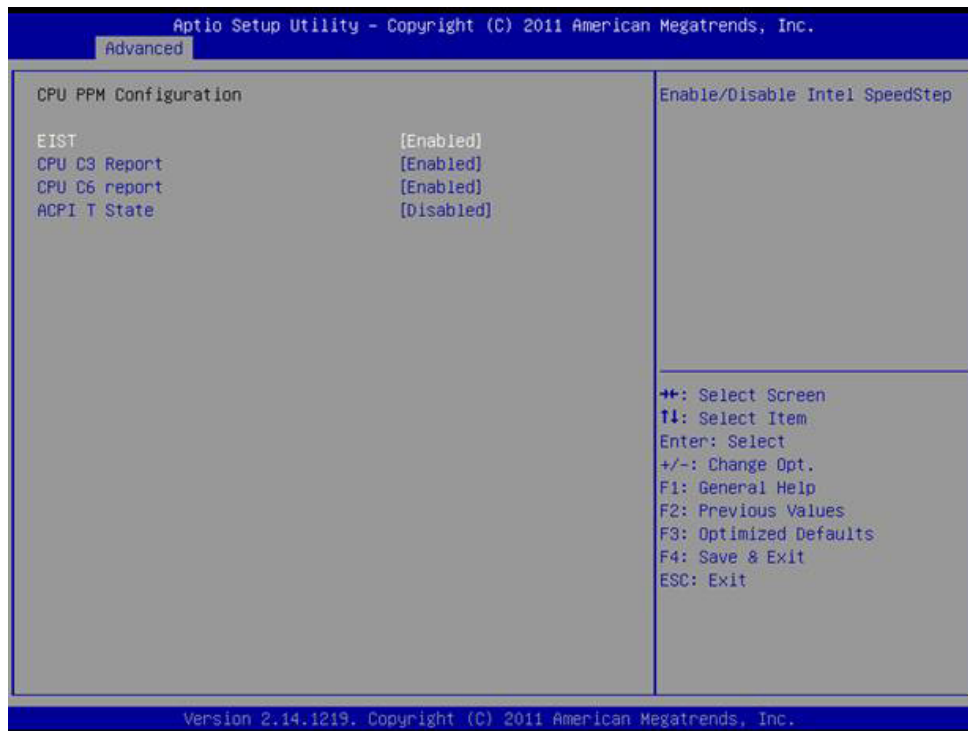

- **EIST [Enabled]**
This item can enable / disable Intel CPU speed step.
- **CPU C3 Report [Enabled]**
- **CPU C6 report [Enabled]**
- **ACPI T State [Disabled]**

3.5 Chipset Configuration Setting

Select the chipset tab from the BIOS setup screen to enter the Chipset Setup screen. Users can select any item in the left frame of the screen, such as PCI express Configuration, to go to the sub menu for that item. Users can display a Chipset Setup option by highlighting it using the <Arrow> keys. All Chipset Setup options are described in this section. The Chipset Setup screens are shown below. The sub menus are described on the following pages.

3.5.1 PCH-IO Configuration



3.5.1.1 PCI Express Configuration

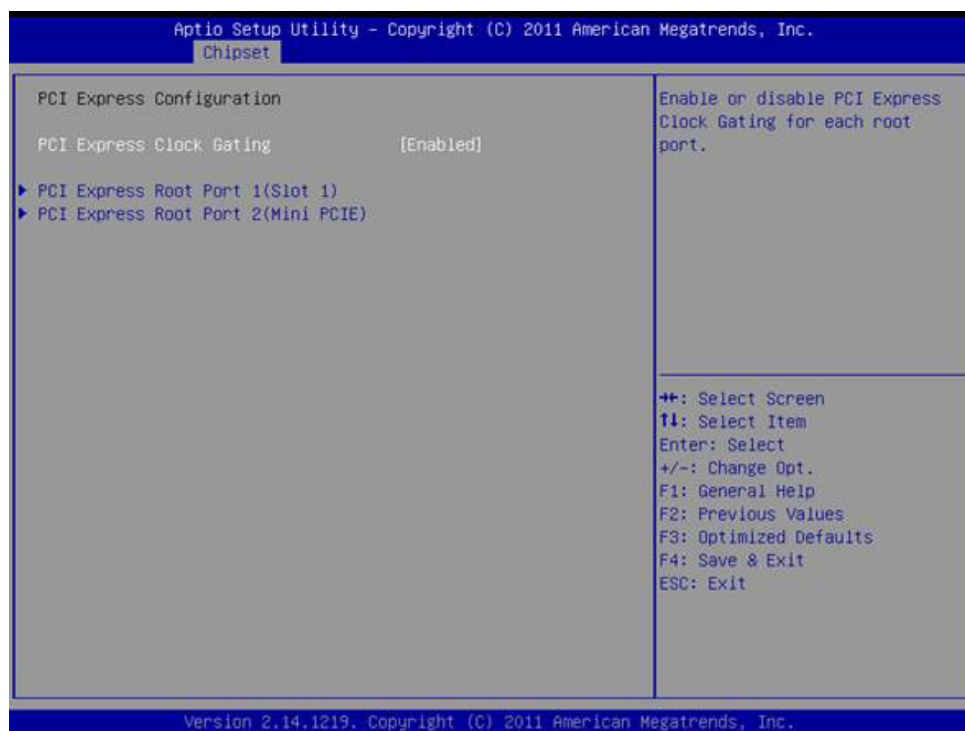

- **PCI Express Clock Gating [Enabled]**
 - PCI Express Root Port 1 (Slot 1)
 - PCI Express Root Port 2 (Mini PCIE)

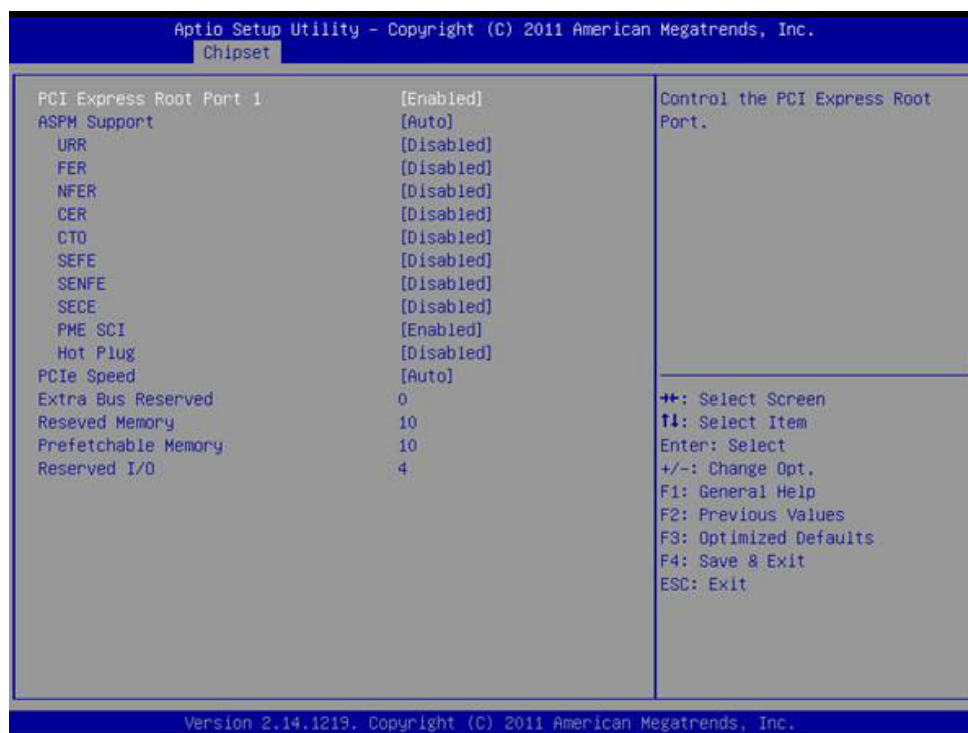

- **PCI Express Root Port 1 (PCIe x1 slot) [Enabled]**
Control the PCI express root port.
- **ASPM Support [Auto]**
- **PCIe Speed [Auto]**

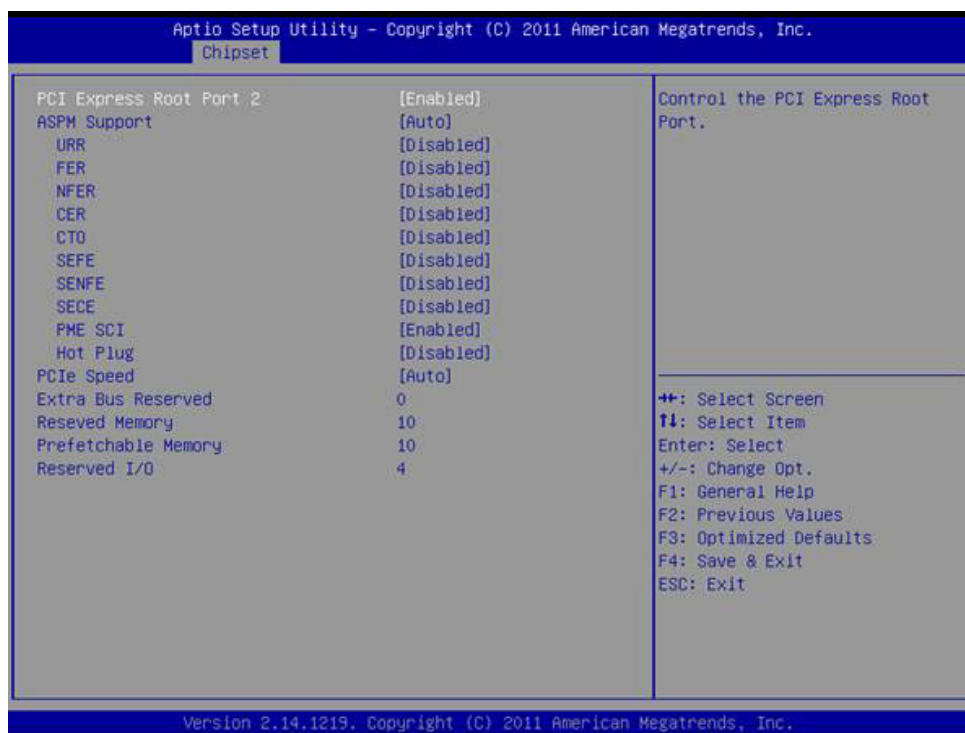

- **PCI Express Root Port 2 (mini PCIe slot) [Enabled]**
- **ASPM Support [Auto]**
- **PCIe Speed [Auto]**

3.5.1.2 USB Configuration

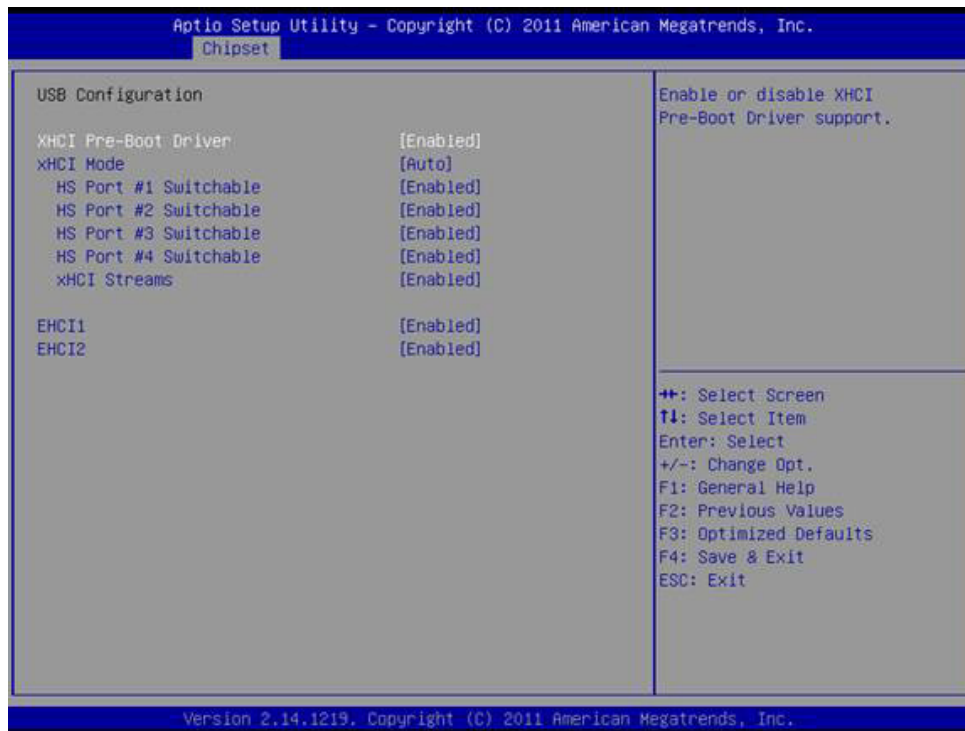

- **XHCI Pre-Boot Driver [Enabled]**
Enable or disable XHCI Pre-Boot Driver support.
- **XHCI Mode [Auto]**
- **EHCI1 [Enabled]**
- **EHCI2 [Enabled]**

3.5.1.3 PCH Azalia Configuration



- **Azalia [Auto]**
This item set for control Detection of the Azalia device.
 - [Disabled] = Azalia will be unconditionally disabled.
 - [Enabled] = Azalaz will be unconditionally enabled
 - [Auto] = Azaliz will be enabled if present, disabled otherwise.

3.5.2 System Agent (SA) Configuration



3.5.2.1 Graphics Configuration



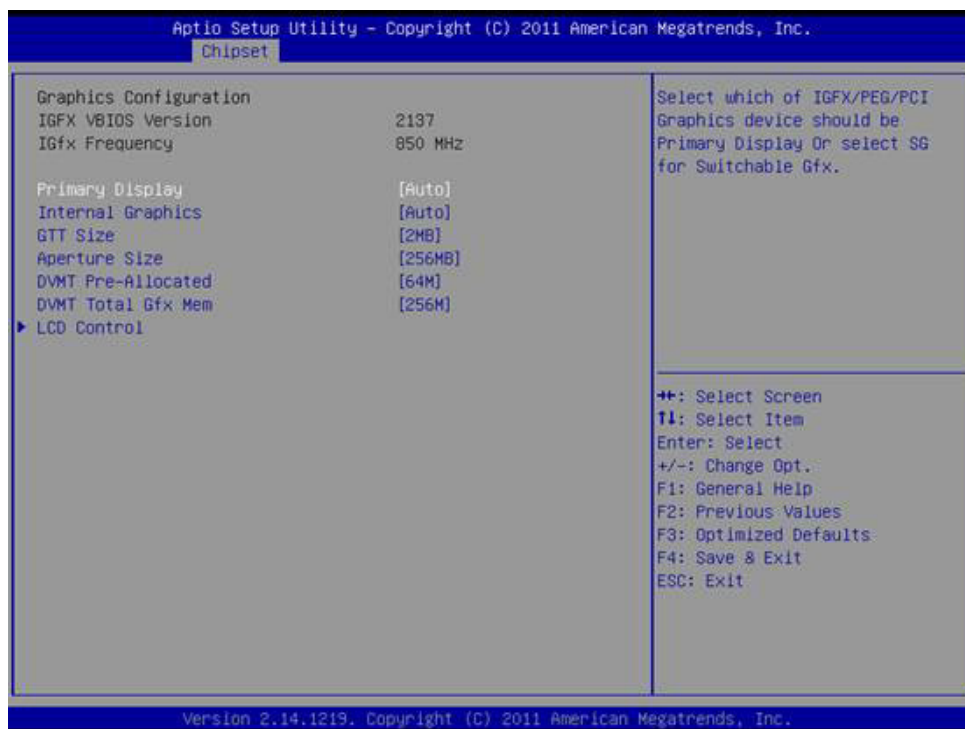

- **Primary Display [Auto]**
Select which of IGFX/PEG/PCI Graphics device should be primary display or select SG for switchable Gfx.
- **Internal Graphics [Auto]**

LCD Control



■ **Primary IGFX Boot Display [VBIOS Default]**

Select the video device which will be activated during POST. There is no effect if external graphics are present. Secondary boot display selection will appear based on your selection.

VGA modes will be supported only on primary display.

Note! When BIOS set as "VBIOS Default", only CRT is supported as the single display under DOS.



Note! The triple display can only work under Windows 7, it is not supported in Windows XP and Linux, and the 2nd and 3rd display can not work under DOS.



3.5.2.2 DMI Configuration



■ **DMI Vc1 Control [Enabled]**

3.5.2.3 NB PCIe Configuration



3.5.2.4 Memory Information

This section shows you the information about the memory you insert, included memory RC version, frequency, total size, size per DIMM, minimum delay time.

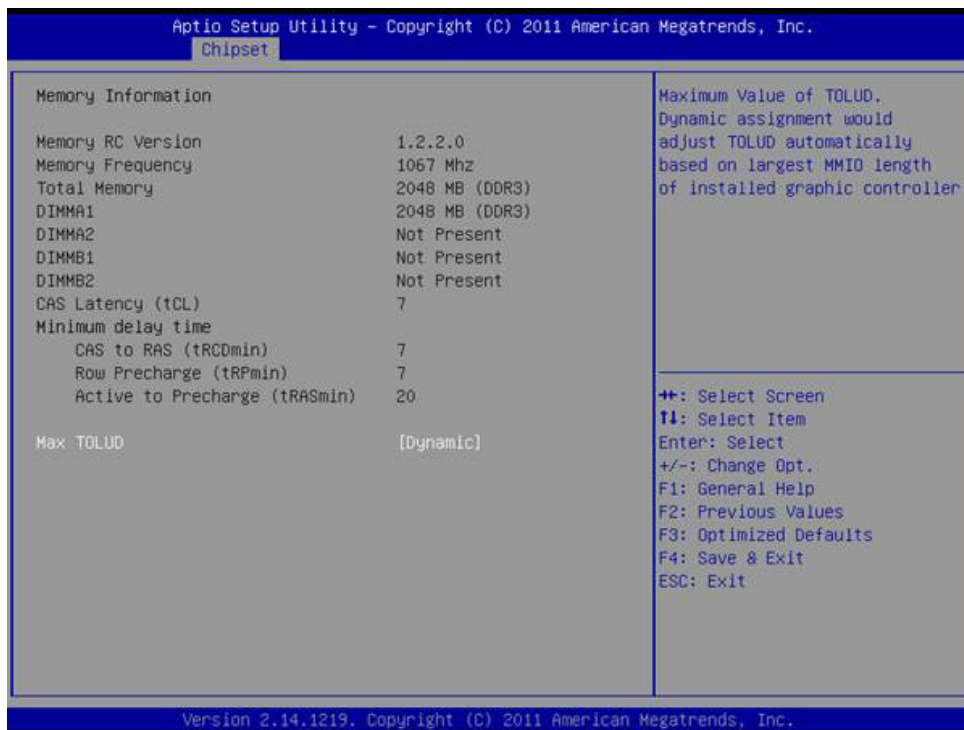

- **Max TOLUD [Dynamic]**

Dynamic assignment would adjust TOLUD automatically based on largest MMIO length of installed graphic controller.

3.6 Boot Setting

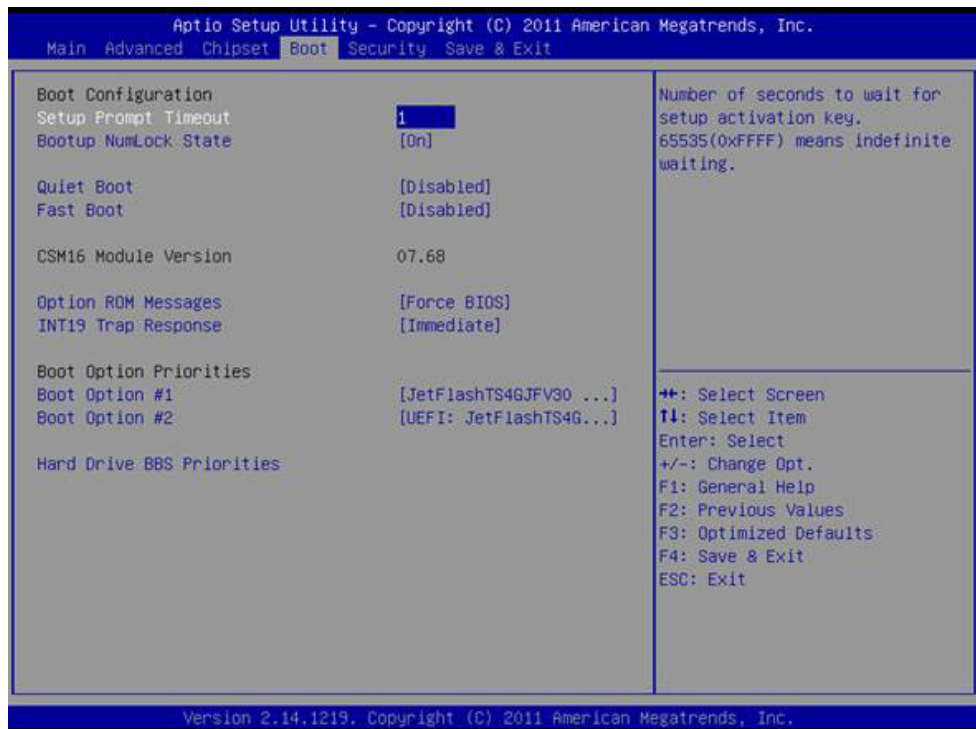

- **Setup Prompt Timeout**
Use the <+> and <-> keys to adjust the number of seconds to wait for setup activation key.
- **Bootup NumLock State [On]**
On or Off power on state for the NumLock.
- **Quiet Boot [Disabled]**
If this option is set to disabled, the BIOS display normal POST messages. If enabled, an OEM logo is shown instead of POST messages.
- **Fast Boot [Disabled]**
- **Option ROM Messages [Force BIOS]**
Force BIOS or Keep Current to set the display mode.
- **INT19 Trap Response [Immediate]**
Enable Option ROM to trap Interrupt 19 immediately.
- **Boot Option #1/#2**
Choose boot priority from boot device.

3.7 Security Setting



- **Administrator Password**
Select this option and press <ENTER> to access the sub menu, and then type in the password. Set the Administrator password.
- **User Password**
Select this option and press <ENTER> to access the sub menu, and then type in the password. Set the User Password.

3.8 Save & Exit Configuration

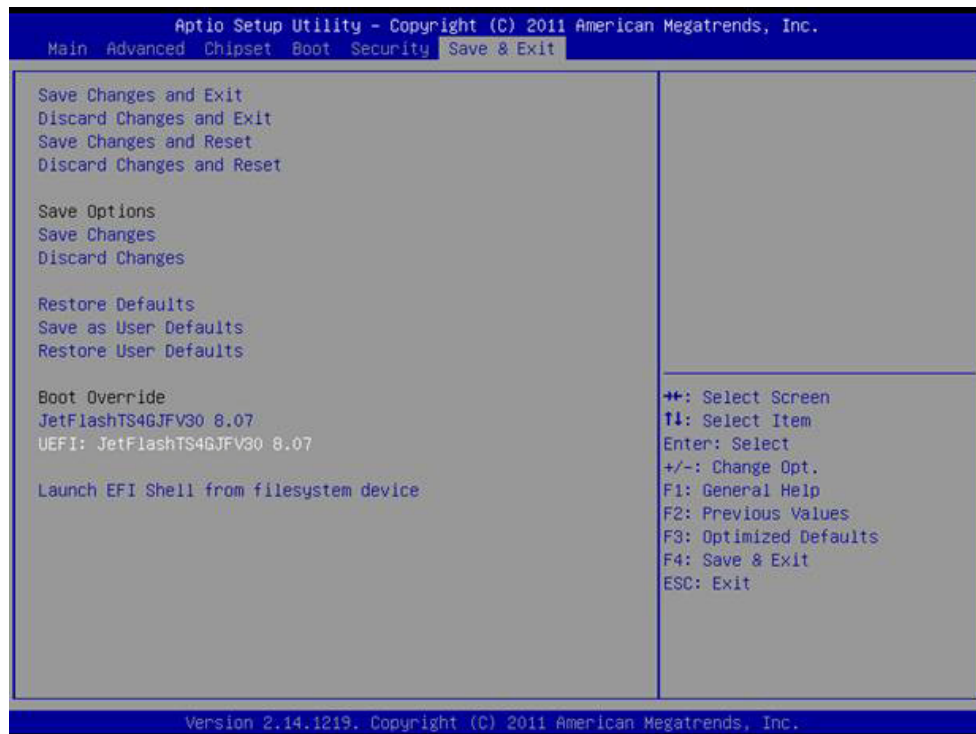

■ Save Changes and Exit

When users have completed system configuration, select this option to save changes, exit BIOS setup menu and reboot the computer to take effect all system configuration parameters.

1. Select Exit Saving Changes from the Exit menu and press <Enter>. The following message appears: Save Configuration Changes and Exit Now? [Ok] [Cancel]
2. Select Ok or cancel.

■ Discard Changes and Exit

Select this option to quit Setup without making any permanent changes to the system configuration.

1. Select Exit Discarding Changes from the Exit menu and press <Enter>. The following message appears: Discard Changes and Exit Setup Now? [Ok] [Cancel]
2. Select Ok to discard changes and exit. Discard Changes
Select Discard Changes from the Exit menu and press <Enter>.

■ Restore Default

The BIOS automatically configures all setup items to optimal settings when users select this option. Defaults are designed for maximum system performance, but may not work best for all computer applications. In particular, do not use the Defaults if the user's computer is experiencing system configuration problems. Select Restore Defaults from the Exit menu and press <Enter>.

■ Save as User Default

Save the all current settings as a user default.

■ Restore User Default

Restore all settings to user default values.

■ Boot Override

Shows the boot device types on the system.

Chapter 4

Software Introduction
& Service

4.1 Introduction

The mission of Advantech Embedded Software Services is to "Enhance quality of life with Advantech platforms and Microsoft® Windows® embedded technology." We enable Windows® Embedded software products on Advantech platforms to more effectively support the embedded computing community. Customers are freed from the hassle of dealing with multiple vendors (hardware suppliers, system integrators, embedded OS distributors) for projects. Our goal is to make Windows® Embedded Software solutions easily and widely available to the embedded computing community.

4.2 Value-Added Software Services

Software API: An interface that defines the ways by which an application program may request services from libraries and/or operating systems. Provides not only the underlying drivers required but also a rich set of user-friendly, intelligent and integrated interfaces, which speeds development, enhances security and offers add-on value for Advantech platforms. It plays the role of catalyst between developer and solution, and makes Advantech embedded platforms easier and simpler to adopt and operate with customer applications.

4.2.1 Software API

4.2.1.1 Control

GPIO



General Purpose Input/Output is a flexible parallel interface that allows a variety of custom connections. It allows users to monitor the level of signal input or set the output status to switch on/off the device. Our API also provides Programmable GPIO, which allows developers to dynamically set the GPIO input or output status.

4.2.1.2 Display

Brightness Control



The Brightness Control API allows a developer to access embedded devices and easily control brightness.

Backlight



The Backlight API allows a developer to control the backlight (screen) on/off in embedded devices.

4.2.1.3 Monitor

Watchdog



A watchdog timer (WDT) is a device that performs a specific operation after a certain period of time if something goes wrong and the system does not recover on its own. A watchdog timer can be programmed to perform a warm boot (restarting the system) after a certain number of seconds.

Hardware Monitor



The Hardware Monitor (HWM) API is a system health supervision API that inspects certain condition indexes, such as fan speed, temperature and voltage.

4.2.1.4 Power Saving

CPU Speed



Makes use of Intel SpeedStep technology to save power consumption. The system will automatically adjust the CPU speed depending on the system loading.

System Throttling

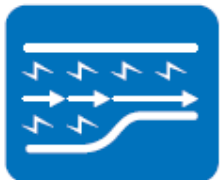

Refers to a series of methods for reducing power consumption in computers by lowering the clock frequency. This API allows the user to adjust the clock from 87.5% to 12.5%.

4.2.2 Software Utility

BIOS Flash

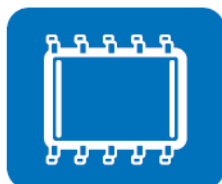

The BIOS Flash utility allows customers to update the flash ROM BIOS version, or use it to back up current BIOS by copying it from the flash chip to a file on the customers' disk. The BIOS Flash utility also provides a command line version and an API for fast implementation into customized applications.

Embedded Security ID



The embedded application is the most important property of a system integrator. It contains valuable intellectual property, design knowledge and innovation - but it is easy to be copy. Embedded Security ID utility provides reliable security functions for customers to secure their application data within embedded BIOS.

Monitoring



Monitoring is a utility for customers to monitor system health, like voltage, CPU and system temperature and fan speed. These items are important to a device, if critical errors occur and are not solved immediately, permanent damage may be caused.

eSOS



eSOS is a small OS stored in BIOS ROM. It will boot up in case of a main OS crash. It will diagnose the hardware status, and then send an e-mail to the designated administrator. eSOS also provides for remote connection via Telnet server and FTP server so the administrator can attempt to rescue the system. Note: This function requires BIOS customization.

Chapter 5

Chipset Software
Installation Utility

5.1 Before You Begin

To facilitate the installation of the enhanced display drivers and utility software, read the instructions in this chapter carefully. The drivers for AIMB-502 are located on the software installation CD. The driver in the folder of the driver CD will guide and link you to the utilities and drivers under a Windows system. Updates are provided via Service Packs from Microsoft*.

Note! *The files on the software installation CD are compressed. Do not attempt to install the drivers by copying the files manually. You must use the supplied SETUP program to install the drivers.*



Before you begin, it is important to note that most display drivers need to have the relevant software application already installed in the system prior to installing the enhanced display drivers. In addition, many of the installation procedures assume that you are familiar with both the relevant software applications and operating system commands. Review the relevant operating system commands and the pertinent sections of your application software's user manual before performing the installation.

5.2 Introduction

The Intel® Chipset Software Installation (CSI) utility installs the Windows INF files that outline to the operating system how the chipset components will be configured. This is needed for the proper functioning of the following features:

- Core PCI PnP services
- IDE Ultra ATA 100/66/33 and Serial ATA interface support
- USB 1.1/2.0 support (USB 2.0 driver needs to be installed separately for Win98)
- Identification of Intel® chipset components in the Device Manager

Note! *This utility is used for the following versions of Windows, and it has to be installed **before** installing all the other drivers:*



- Windows 7 (32-bit)
- Windows 7 (64-bit)
- Windows XP professional edition (32-bit)
- Windows XP professional edition (64-bit)

5.3 Windows XP/Windows 7 Driver Setup

1. Insert the driver CD into your system's CD-ROM drive. Navigate to the "01. Chip" folder and click "infnst.autol.exe" to complete driver installation.

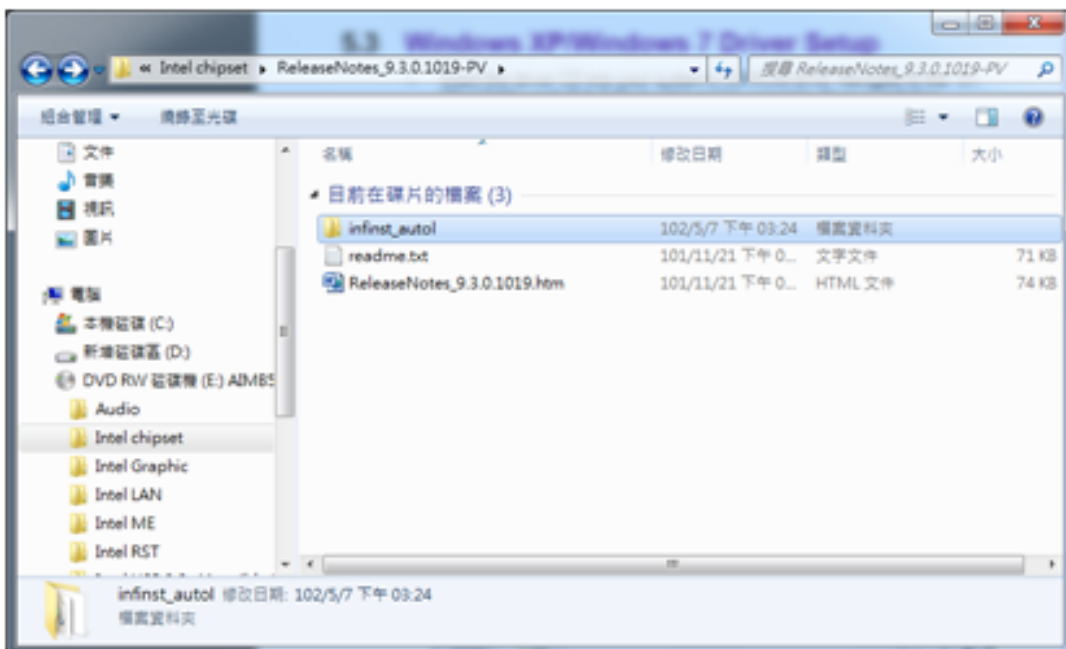
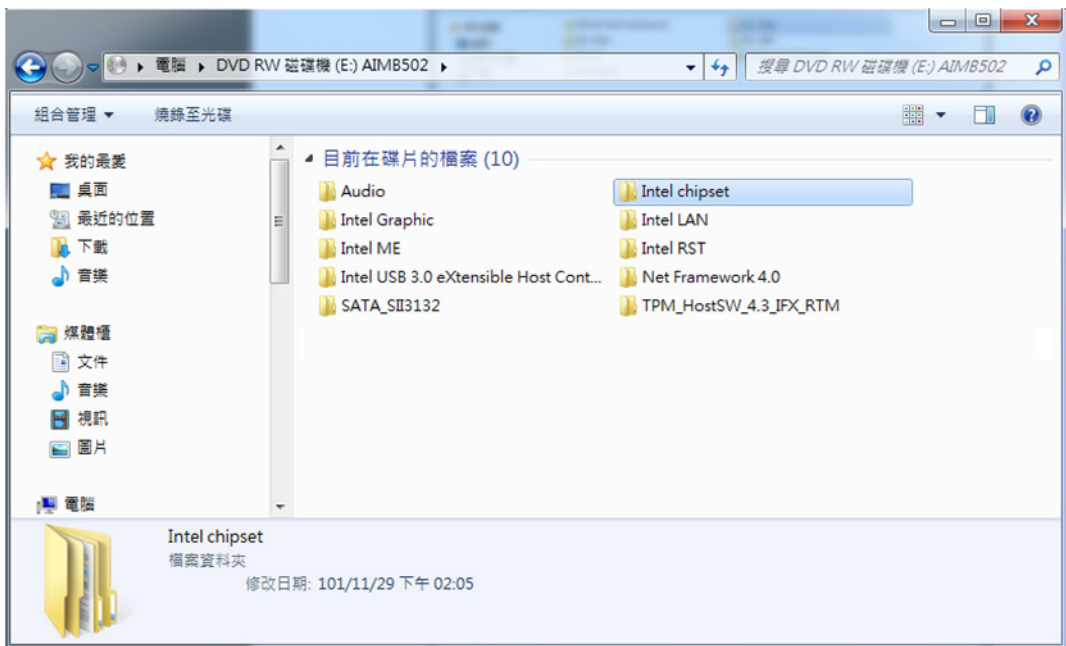

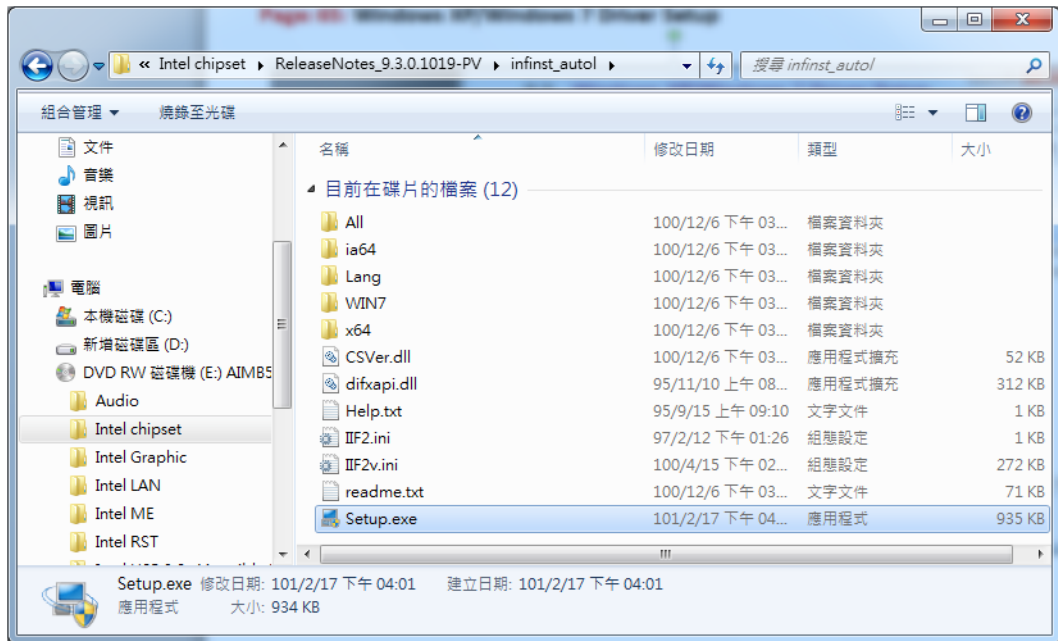

Chapter 6

VGA Setup

6.1 Introduction

The Intel mobile Core i7-2600, Core i5-2400, Core i3-2120, Core i7-3770, Core i5-3550S, Core i3-3220, Pentium G850, Celeron G540 CPUs with dual cores are embedded with an integrated graphics controller. You need to install the VGA driver to enable this function.

Optimized integrated graphic solution: With Intel Graphics Flexible, versatile display options and 32-bit 3D graphics engine are supported. Dual independent displays and enhanced display modes for widescreen flat panels include extended, twin, and clone dual display modes, plus optimized 3D support delivers an intensive and realistic visual experience.

6.2 Windows 7/XP

Note! Before installing this driver, make sure the CSI utility has been installed in your system. See Chapter 5 for information on installing the CSI utility.



Insert the driver CD into your system's CD-ROM drive. Navigate to the "VGA" folder and click "setup.exe" to complete the installation of the drivers for Windows 7 and Windows XP.

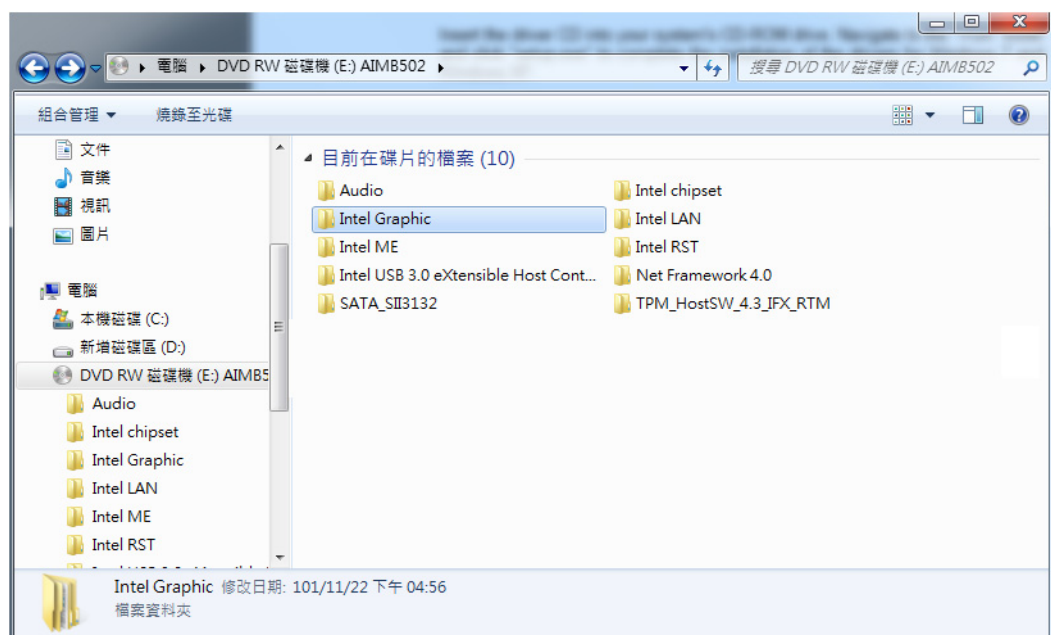

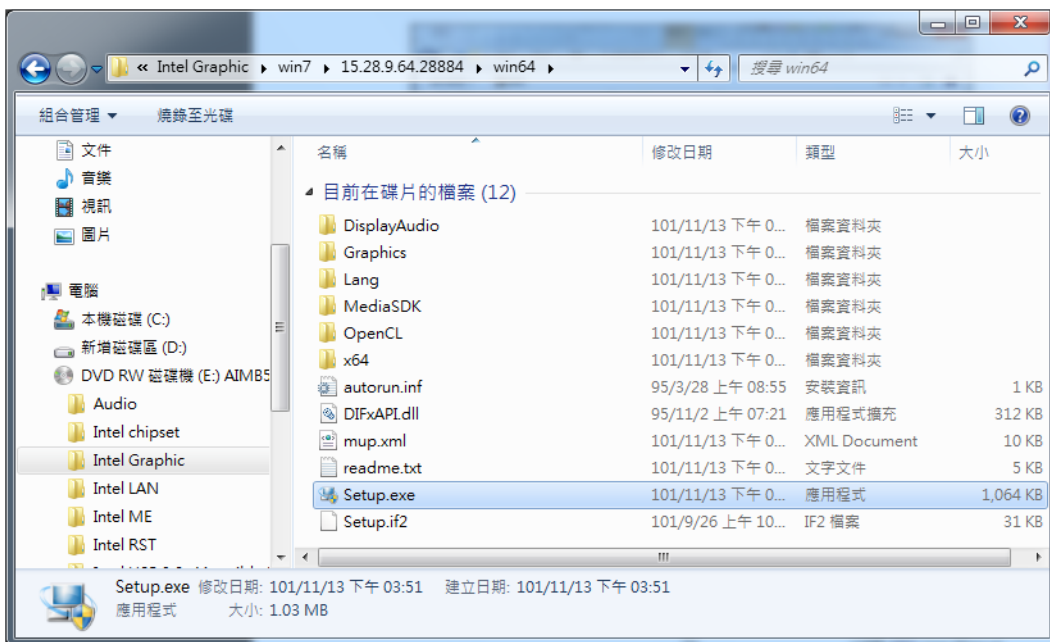
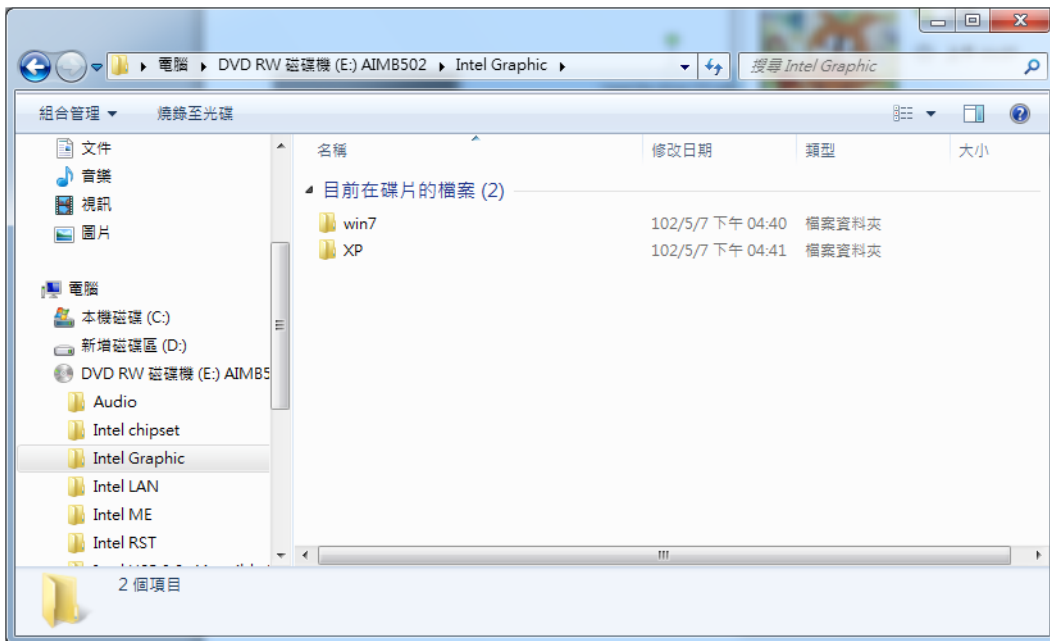

Chapter 7

LAN Configuration

7.1 Introduction

The AIMB-502 has dual Gigabit Ethernet LANs via dedicated PCI Express x1 lanes (Intel 82579LM (LAN1) and 82583V (LAN2)) that offer bandwidth of up to 500 MB/sec, eliminating the bottleneck of network data flow and incorporating Gigabit Ethernet at 1000 Mbps.

7.2 Features

- Integrated 10/100/1000 Mbps transceiver
- 10/100/1000 Mbps triple-speed MAC
- High-speed RISC core with 24-KB cache
- On-chip voltage regulation
- Wake-on-LAN (WOL) support
- PCI Express X1 host interface

7.3 Installation

Note! *Before installing the LAN drivers, make sure the CSI utility has been installed on your system. See Chapter 5 for information on installing the CSI utility.*



The AIMB-502's Intel 82579LM (LAN1) and 82583V (LAN2) Gigabit integrated controllers support all major network operating systems. However, the installation procedure varies from system to system. Please find and use the section that provides the driver setup procedure for the operating system you are using.

7.4 Windows® 7/XP Driver Setup (Intel 82579LM/82574L)

Insert the driver CD into your system's CD-ROM drive. Select the LAN folder then navigate to the directory for your OS.

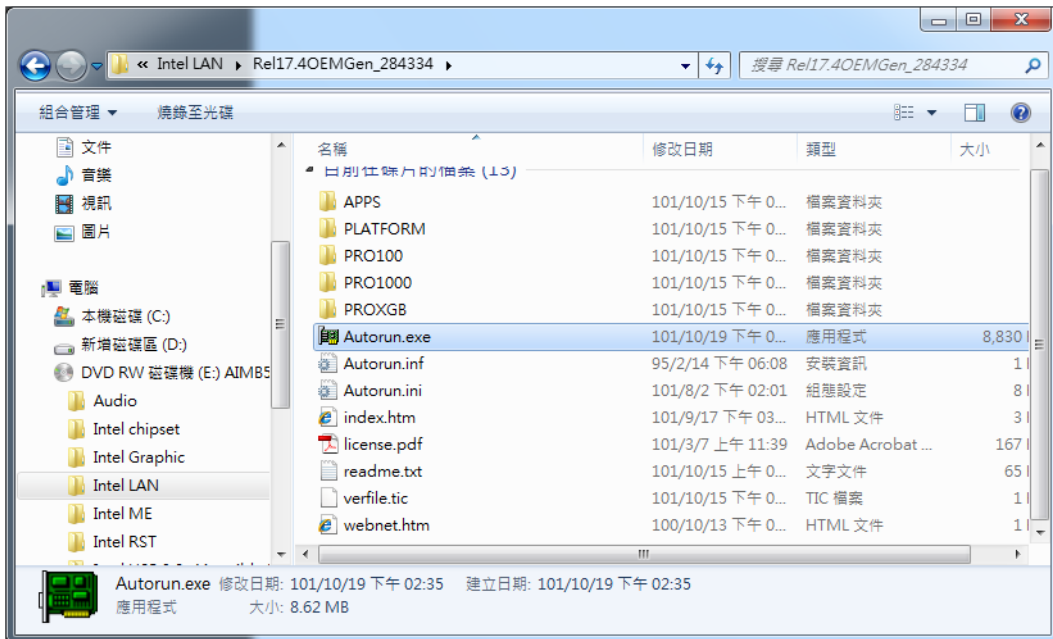
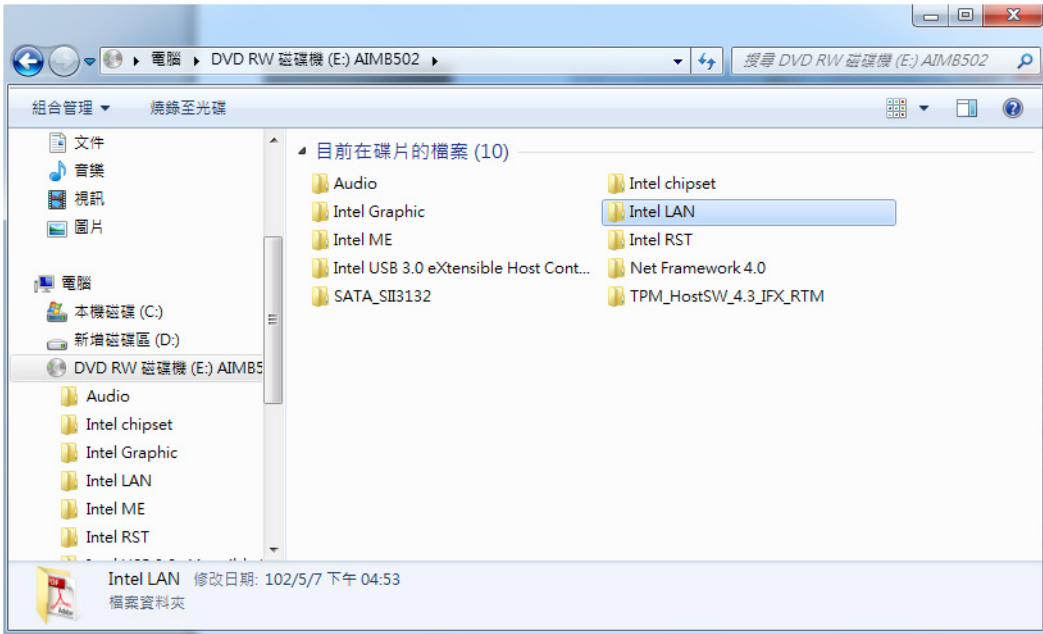

Appendix **A**

Programming the
Watchdog Timer

A.1 Programming the Watchdog Timer

AIMB-502's watchdog timer can be used to monitor system software operation and take corrective action if the software fails to function within the programmed period. This section describes the operation of the watchdog timer and how to program it.

A.1.1 Watchdog Timer Overview

The watchdog timer is built into the super I/O controller Nuvoton NCT6106D. It provides the following user-programmable functions:

- Can be enabled and disabled by user program
- Timer can be set from 1 to 255 seconds or 1 to 255 minutes
- Generates an interrupt or resets signal if the software fails to reset the timer before time-out

A.1.2 Programming the Watchdog Timer

The I/O port address of the watchdog timer is 2E (hex) and 2F (hex). 2E (hex) is the address port. 2F (hex) is the data port. You must first assign the address of register by writing an address value into address port 2E (hex), then write/read data to/from the assigned register through data port 2F (hex).

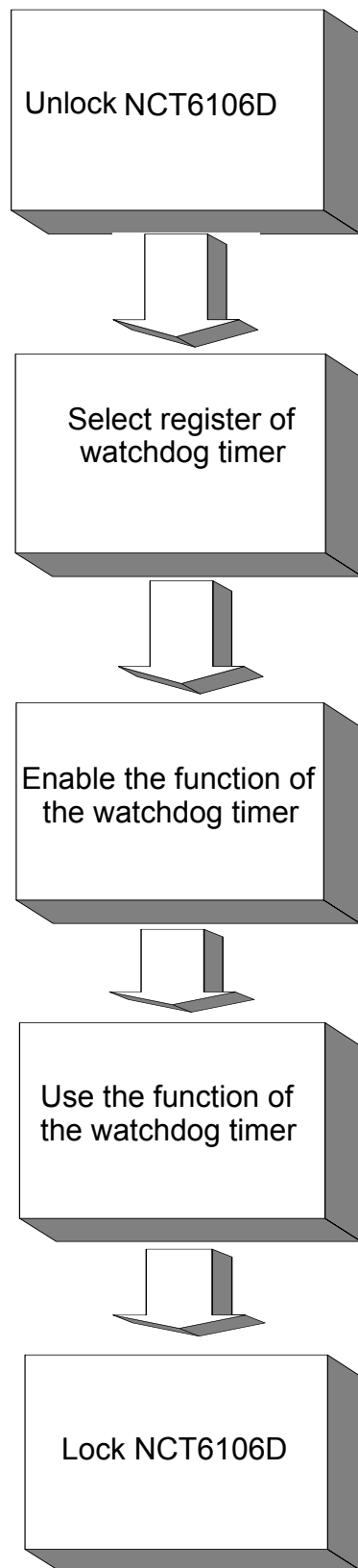

Table A.1: Watchdog Timer Registers

Address of Register (2E)	Attribute	Value (2F) & description
87 (hex)	-----	Write this address to I/O address port 2E (hex) twice to unlock the NCT6106D.
07 (hex)	write	Write 08 (hex) to select register of watchdog timer.
30 (hex)	write	Write 01 (hex) to enable the function of the watchdog timer. Disabled is set as default.
F0 (hex)	write	Set seconds or minutes as units for the timer. Write 0 to bit 3: set second as counting unit. [default] Write 1 to bit 3: set minutes as counting unit.
F1 (hex)	write	0: stop timer [default] 01~FF (hex): The amount of the count, in seconds or minutes, depends on the value set in register F5 (hex). This number decides how long the watchdog timer waits for strobe before generating an interrupt or reset signal. Writing a new value to this register can reset the timer to count with the new value.
F2 (hex)	read/write	Bit 7: Write 1 to enable mouse to reset the timer, 0 to disable [default]. Bit 6: Write 1 to enable keyboard to reset the timer, 0 to disable. [default] Bit 5: Write 1 to generate a timeout signal immediately and automatically return to 0. [default=0] Bit 4: Read status of watchdog timer, 1 means timer is "timeout".
AA (hex)	-----	Write this address to I/O port 2E (hex) to lock the watchdog timer 2.

A.1.3 Example Program

1. Enable watchdog timer and set 10 sec. as timeout interval

```

;-----
Mov dx,2eh ; Unlock NCT6106D
Mov al,87h
Out dx,al
Out dx,al
;-----
Mov al,07h ; Select registers of watchdog timer
Out dx,al
Inc dx
Mov al,08h
Out dx,al
;-----
Dec dx ; Enable the function of watchdog timer
Mov al,30h
Out dx,al
Inc dx
Mov al,01h
Out dx,al
;-----
Dec dx ; Set second as counting unit
Mov al,0f0h
Out dx,al
Inc dx
In al,dx
And al,not 08h
Out dx,al
;-----
Dec dx ; Set timeout interval as 10 seconds and start counting
Mov al,0f1h
Out dx,al
Inc dx
Mov al,10
Out dx,al
;-----
Dec dx ; Lock NCT6106D
Mov al,0aah
Out dx,al

```

2. Enable watchdog timer and set 5 minutes as timeout interval

```

;-----
Mov dx,2eh ; Unlock NCT6106D
Mov al,87h
Out dx,al
Out dx,al

```

```

;-----
Mov al,07h ; Select registers of watchdog timer
Out dx,al
Inc dx
Mov al,08h
Out dx,al
;-----
Dec dx ; Enable the function of watchdog timer
Mov al,30h
Out dx,al
Inc dx
Mov al,01h
Out dx,al
;-----
Dec dx ; Set minute as counting unit
Mov al,0f0h
Out dx,al
Inc dx
In al,dx
Or al,08h
Out dx,al
;-----
Dec dx ; Set timeout interval as 5 minutes and start counting
Mov al,0f1h
Out dx,al
Inc dx
Mov al,5
Out dx,al
;-----
Dec dx ; Lock NCT6106D
Mov al,0aah
Out dx,al
3. Enable watchdog timer to be reset by mouse
;-----
Mov dx,2eh ; Unlock NCT6106D
Mov al,87h
Out dx,al
Out dx,al
;-----
Mov al,07h ; Select registers of watchdog timer
Out dx,al
Inc dx
Mov al,08h
Out dx,al
;-----

```

```

Dec dx ; Enable the function of watchdog timer
Mov al,30h
Out dx,al
Inc dx
Mov al,01h
Out dx,al
;-----
Dec dx ; Enable watchdog timer to be reset by mouse
Mov al,0f2h
Out dx,al
Inc dx
In al,dx
Or al,80h
Out dx,al
;-----
Dec dx ; Lock NCT6106D
Mov al,0aah
Out dx,al
4. Enable watchdog timer to be reset by keyboard
;-----
Mov dx,2eh ; Unlock NCT6106D
Mov al,87h
Out dx,al
Out dx,al
;-----
Mov al,07h ; Select registers of watchdog timer
Out dx,al
Inc dx
Mov al,08h
Out dx,al
;-----
Dec dx ; Enable the function of watchdog timer
Mov al,30h
Out dx,al
Inc dx
Mov al,01h
Out dx,al
;-----
Dec dx ; Enable watchdog timer to be strobed reset by keyboard
Mov al,0f2h
Out dx,al
Inc dx
In al,dx
Or al,40h
Out dx,al

```

```

;-----
Dec dx ; Lock NCT6106D
Mov al,0aah
Out dx,al
5. Generate a time-out signal without timer counting
;-----
Mov dx,2eh ; Unlock NCT6106D
Mov al,87h
Out dx,al
Out dx,al
;-----
Mov al,07h ; Select registers of watchdog timer
Out dx,al
Inc dx
Mov al,08h
Out dx,al
;-----
Dec dx ; Enable the function of watchdog timer
Mov al,30h
Out dx,al
Inc dx
Mov al,01h
Out dx,al
;-----
Dec dx ; Generate a time-out signal
Mov al,0f2h
Out dx,al ;Write 1 to bit 5 of F7 register
Inc dx
In al,dx
Or al,20h
Out dx,al
;-----
Dec dx ; Lock NCT6106D
Mov al,0aah
Out dx,al

```

Appendix **B**

Pin Assignments

B.1 RS-232 Interface (COM2)

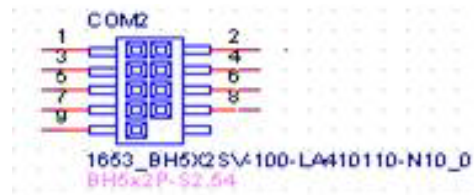

Table B.1: RS232 Serial Port (COM2)

Pin	Pin Name	Pin	Pin Name
1	COM2_DCD#	6	COM2_CTS#
2	COM2_DSR#	7	COM2_DTR#
3	COM2_SIN	8	COM2_RI#
4	COM2_RTS#	10	GND
5	COM2_SOUT		

B.2 RS-232 Interface (COM3456)

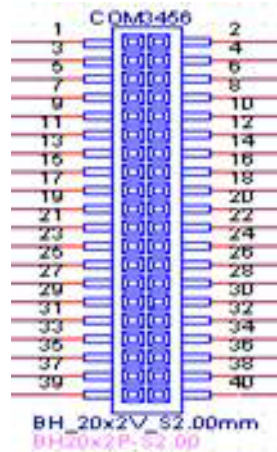

Table B.2: RS-232 Serial Port (COM3456)

Pin	Pin Name	Pin	Pin Name
1	COM3_DCD#	2	COM3_DSR#
3	COM3_SIN	4	COM3_RTS#
5	COM3_SOUT	6	COM3_CTS#
7	COM3_DTR#	8	COM3_RI#
9	GND	10	GND
11	COM4_DCD#	12	COM4_DSR#
13	COM4_SIN	14	COM4_RTS#
15	COM4_SOUT	16	COM4_CTS#
17	COM4_DTR#	18	COM4_RI#
19	GND	20	GND
21	COM5_DCD#	22	COM5_DSR#
23	COM5_SIN	24	COM5_RTS#
25	COM5_SOUT	26	COM5_CTS#

Table B.2: RS-232 Serial Port (COM3456)

27	COM5_DTR#	28	COM5_RI#
29	GND	30	GND
31	COM6_DCD#	32	COM6_DSR#
33	COM6_SIN	34	COM6_RTS#
35	COM6_SOUT	36	COM6_CTS#
37	COM6_DTR#	38	COM6_RI#
39	GND	40	GND

B.3 USB 2.0 Header (USB89)

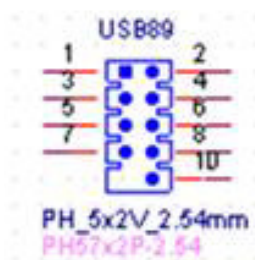
**Table B.3: USB 2.0 Header (COM89)**

Pin	Pin Name	Pin	Pin Name
1	+V5	2	+ V5
3	USB8N	4	USB9N
5	USB8P	6	USB9P
7	GND	8	GND
		10	NC

B.4 Serial ATA III (SATA 1~2)

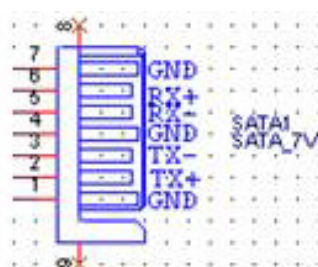
**Table B.4: Serial ATA III (6Gb/s)**

Pin	Pin Name	Pin	Pin Name
1	GND	5	RX-
2	TX+	6	RX+
3	TX-	7	GND
4	GND	?	

B.5 Serial ATA II (SATA 3~4, SATARAID1~4)

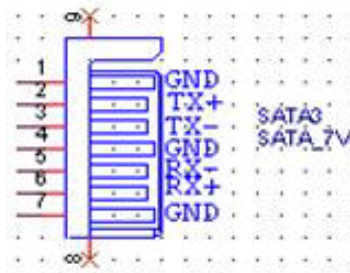

Table B.5: Serial ATA II (3Gb/s)

Pin	Pin Name	Pin	Pin Name
1	GND	5	RX-
2	TX+	6	RX+
3	TX-	7	GND
4	GND		

B.6 AT/ATX Mode Connector (PSON1)

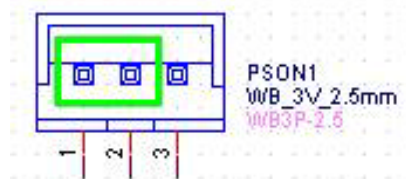

Table B.6: AT/ATX Mode Connector (PSON1)

Pin	Pin Name
1	AT
2	+V3.3
3	ATX
* ATX mode (2-3 short) / AT mode (1-2 short)	

B.7 ATX Power Connector (EATPWR1)

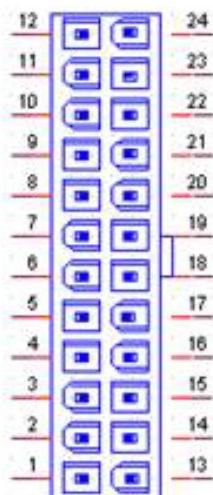

Table B.7: ATX 24 pin main power connector

Pin	Pin Name	Pin	Pin Name
1	+3.3V	13	+3.3V
2	+3.3V	14	-12V
3	GND	15	GND
4	+5V	16	PS_ON#
5	GND	17	GND
6	+5V	18	GND
7	GND	19	GND
8	ATXPG	20	-5V
9	5VSB	21	+5V
10	+12V	22	+5V
11	+12V	23	+5V
12	+3.3V	24	GND

B.8 ATX 12 V Connector (ATX12V1)

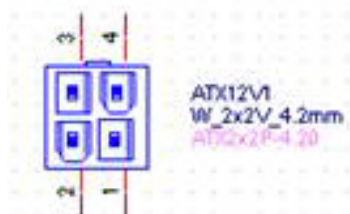

Table B.8: ATX 4 pin main power connector (ATX12V1)

Pin	Pin Name
1	GND
2	GND
3	+V12_4P
4	+V12_4P

B.9 CPU Fan Connector (CPUFAN1)

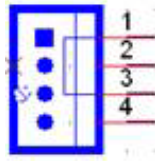

Table B.9: CPU Fan Connector (CPUFAN1)

Pin	Pin Name
1	GND
2	CPU_FAN_PWN
3	CPU_FAN_SPEED
4	NC

B.10 System Fan Power Connector (SYS_FAN1~4)

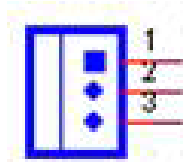

Table B.10: System Fan Power Connector (SYS_FAN1~4)

Pin	Pin Name
1	GND
2	SYS_FAN_PWN
3	SYS_FAN_SPEED

B.11 Audio front panel connector (FPAUD1)

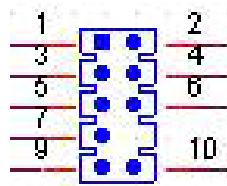

Table B.11: Audio front panel connector (FPAUD1)

Pin	Pin Name	Pin	Pin Name
1	MIC2_L	2	AGND
3	MIC2_R	4	PRESENCE#
5	LINE2-R	6	MIC2-JD
7	FRONT-IO-SENSE_R	8	
9	LINE2-L	10	LINE2-JD

B.12 Digital IO connect (DIO1)

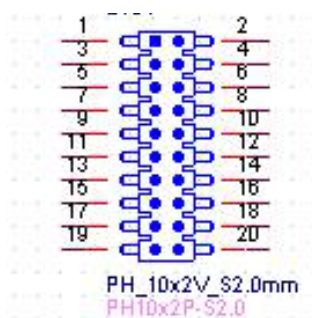

Table B.12: Digital IO connector (DIO1)

Pin	Pin Name	Pin	Pin Name
1	SIO_GPO2	11	SIO_GPO7
2	SIO_GPI4	12	SIO_GPI9
3	SIO_GPO3	13	SIO_GPO8
4	SIO_GPI5	14	NC
5	SIO_GPO4	15	SIO_GPO9
6	SIO_GPI6	16	NC
7	SIO_GPO5	17	+V5_DUAL
8	SIO_GPI7	18	GND
9	SIO_GPO6	19	+V5_DUAL
10	SIO_GPI8	20	GND

B.13 LAN LED (LANLED1)

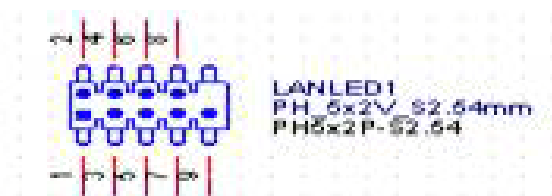

Table B.13: GbE LAN LED (LANLED1)

Pin	Pin Name	Pin	Pin Name
1	LAN1LED0 (LINK/ACTIVITY)	6	LAN2_LED2 (LINK1000)
2	LAN2LED1 (LINK/ACTIVITY)	7	LAN1_LED2 (LINK100)
3	+V3.3_LAN	8	LAN2_LED0 ((LINK100)
4	+V3.3_LAN	9	+V3.3_LAN
5	LAN1LED1 (LINK1000)	?	?

B.14 SPI Flash update connector (SPI_CN1)

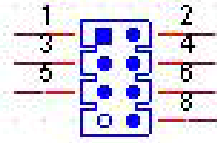

Table B.14: SPI flash update connector (SPI_CN1)

Pin	Pin Name	Pin	Pin Name
1	+3.3V_SPI	2	GND
3	SPI_CS#	4	SPI_CLK
5	SPI_SO_R1	6	SPI_SI
7		8	NC

B.15 COM5 / 6_RI selector Jumper setting (JSETCOM5_V1/ JSETCOM6_V1)

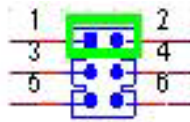

Table B.15: COM5 / 6_RI selector Jumper setting (JSETCOM5_V1/ JSETCOM6_V1)

Pin	Pin Name	Pin	Pin Name
1	COM5(6)_RI#	4	+V5
2	COM5(6)_RI_VA# (CONN)	5	+12V
3	COM5(6)_RI_VA#(CONN)	6	COM5(6)_RI_VA#(CONN)

B.16 Power Switch/HDD LED/Speaker (JFP1+JFP2)

The single board computer has its own buzzer. You can also connect it to the external speaker on your computer chassis.

PWRBTN#(3-6) /RESET#(9-12) /HDD LED(2-5) /Internal Buzzer(7-10 short default) / External speaker(1-10)

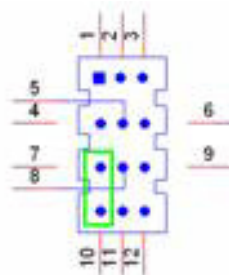

Table B.16: Power Switch/HDD LED/Speaker (JFP1+JFP2)

Pin	Pin Name	Pin	Pin Name
1	+V5	7	SPK_CN17P3
2	+ V3.3	8	SMB_DATA_RESUME
3	PANSWIN#	9	SYS_RST#
4	SPK_CN17P2	10	SPK_CN17P4
5	SATALED#	11	SMB_CLK_RESUME
6	GND	12	GND

B.17 Power LED (JFP3)

You can use an LED to indicate when the single board computer is on. Pin 1 of JFP3 supplies the LED's power.



Table B.17: Power LED (JFP3)

Pin	Pin Name	Pin	Pin Name
1	+3V	4	N/A
2	N/A	5	GND
3	SUSLED	?	?

B.18 IrDA connector (JIR1)

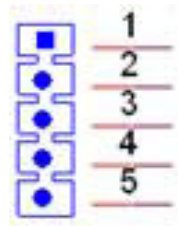

Table B.18: IrDA connector (JIR1)

Pin	Pin Name	Pin	Pin Name
1	+V5	4	GND
2	NC	5	SIO_IRTX
3	SIO_IRRX		

B.19 Case Open sensor (JCASE1)

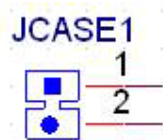

Table B.19: Case Open sensor (JCASE1)

Pin	Pin Name
1	CASEOP#
2	GND

B.20 Case Open Mode Connector (JCASEOP_SW1)

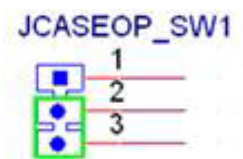

Table B.20: Case Open Mode Connector (JCASEOP_SW1)

Pin	Pin Name
1	CASEOP#
2	HWM_CASEOP#
3	CASEOP

(1-2) Normal close / (2-3) Normal open

B.21 RS-485 terminator jumper setting (J485P)



Table B.21: RS-485 terminator jumper setting (J485P/N)

J485P		J485N	
Pin	Pin Name	Pin	Pin Name
1	N.C	1	N.C.
2	COM1_RS485P	2	COM1_RS485N
3	COM1_RS485P_T	3	COM1_RS485N_T

(1-2): System wasn't set as terminal point / (2-3): System was set as terminal point.
This setting on J485P & J485N should be matched at the same time.

ADVANTECH

Enabling an Intelligent Planet

www.advantech.com

Please verify specifications before quoting. This guide is intended for reference purposes only.

All product specifications are subject to change without notice.

No part of this publication may be reproduced in any form or by any means, electronic, photocopying, recording or otherwise, without prior written permission of the publisher.

All brand and product names are trademarks or registered trademarks of their respective companies.

© Advantech Co., Ltd. 2013