

[About Samsung Electronics Co., Ltd.](#)

Samsung Electronics Co. Ltd inspires the world and shapes the future with transformative ideas and technologies. The company is redefining the worlds of TVs, smartphones, wearable devices, tablets, digital appliances, network systems, and semiconductor and LED solutions. For the latest news, please visit the Samsung Newsroom at <http://news.samsung.com>.

Copyright © 2017 Samsung Electronics Co., Ltd. All rights reserved.  
Samsung Electronics reserves the right to modify, at its sole discretion, the design, packaging, specifications, and features shown herein without notice at any time.

Samsung Electronics Co., Ltd.  
Samsung-ro 1, Giheung-gu, Yongin-si,  
Gyeonggi-do, 17113 Korea

[www.samsungled.com](http://www.samsungled.com)

Apr. 2018 Ver.1

**SAMSUNG**



Samsung LED

## Chip-on-Board LED Packages

D-series  
C-series



**SAMSUNG**

Apr. 2018

**D-series** provides industry-leading performance through a wide range of wattage offerings, and a variety of color rendering index levels can satisfy the need of richer, more vibrant colors.

### The industry-leading performance

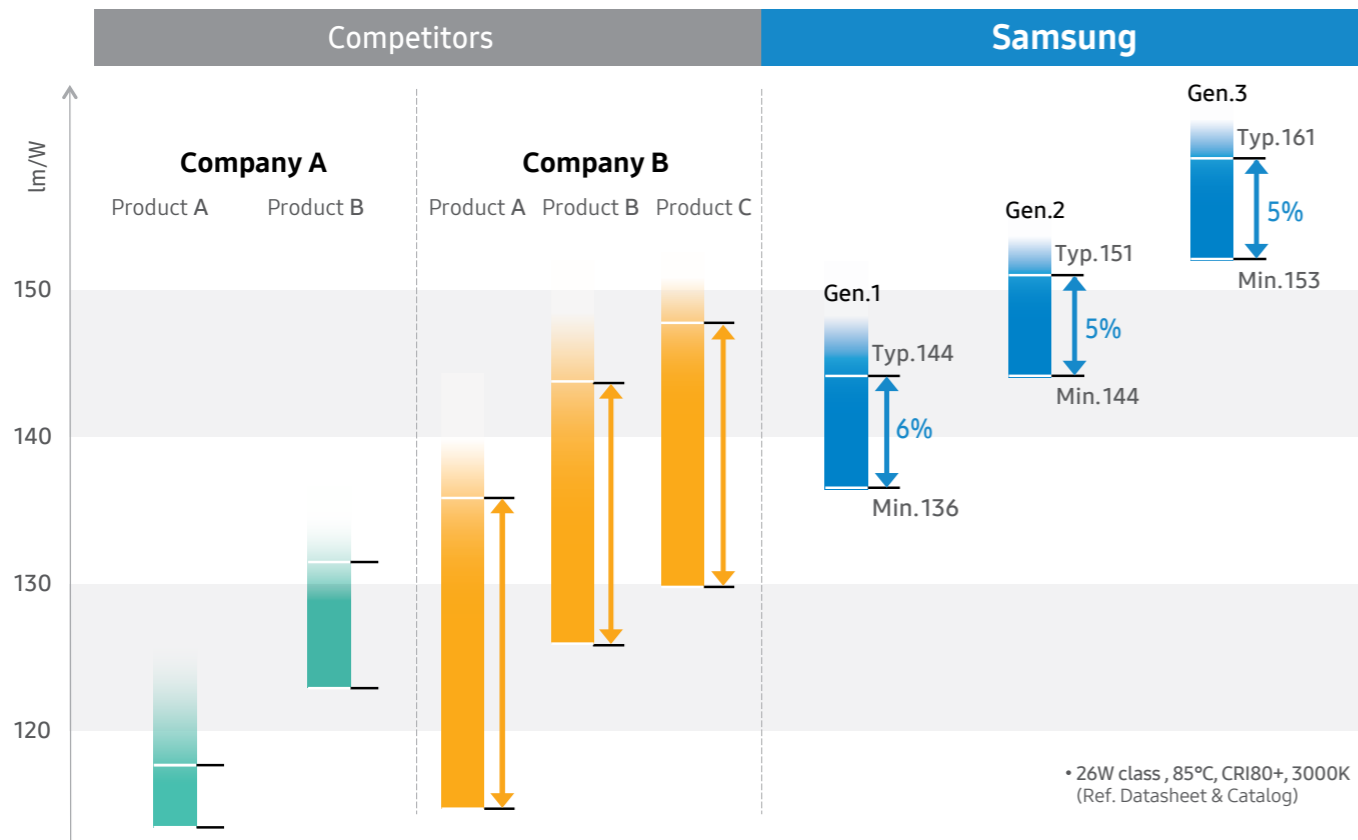

### A wide range of wattage and CRI options

Platform	Model LES	Wattage										Performance (LC026D)	
		3W	6W	9W	13W	16W	19W	26W	33W	40W	60W		80W
Gen 3	CRI 70+			●	●	●	●	●	●	●	●	●	D3 rank: 161lm/W
	CRI 80+	●	●	●	●	●	●	●	●	●	●		
	CRI 90+	●	●	●	●	●	●	●	●	●	●		
Gen 2	CRI 70+			●	●	●	●	●	●	●	●	D2 rank: 151lm/W	
	CRI 80+	●	●	●	●	●	●	●	●	●	●		
	CRI 90+	●	●	●	●	●	●	●	●	●	●		
Gen 1	CRI 70+									●	●	D1 rank: 143lm/W D0 rank: 136lm/W	
	CRI 80+	●	●	●	●	●	●	●	●	●	●		
	CRI 90+	●	●	●	●	●	●	●	●	●	●		

### Suitable for a wide variety of lighting applications

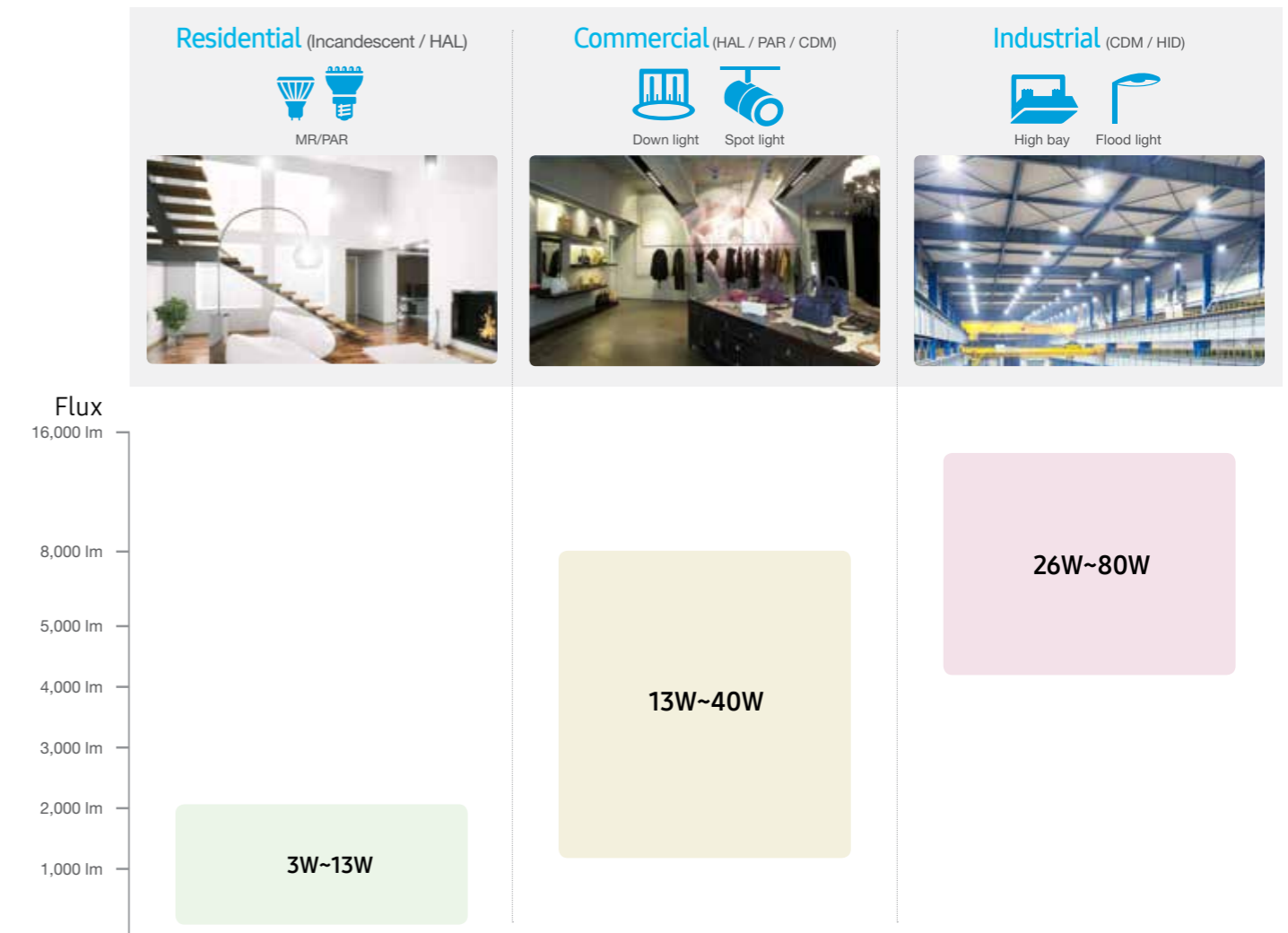

### Premium color line-ups for more effective lighting

Natural color (Ultra High CRI)	Vivid color	Special color
Color value as natural as halogen lamps	Vivid color value for Displaying	Commercial Lighting for Fashion, Meat, Vegetable

# D-series Gen 3







T <sub>j</sub> =85°C	LC003D Gen 3	LC006D Gen 3	LC009D Gen 3	LC013D Gen 3	LC016D Gen 3	LC019D Gen 3	LC026D Gen 3	LC033D Gen 3	LC040D Gen 3	LC060D Gen 3	LC080D Gen 3	
LES	9.8mm			14.5mm				22 mm				
Typical	33.8V											50.7V
	3.0W (90mA)	6.1W (180mA)	9.1W (270mA)	12.2W (360mA)	15.2W (450mA)	18.3W (540mA)	24.3W (720mA)	30.4W (900mA)	36.5W (1080mA)	54.8W (1080mA)	82.1W (1620mA)	
Max.	8.7W (230mA)	17.4W (460mA)	26.1W (690mA)	34.8W (920mA)	43.5W (1150mA)	52.2W (1380mA)	69.6W (1840mA)	86.9W (2300mA)	104.3W (2760mA)	152.9W (2760mA)	229.3W (4140mA)	
Size	13.5mm x 13.5mm			19mm x 19mm				28mm x 28mm				

## Color Variation

※ CRI: Minimum

Product	CRI90+					CRI80+							CRI70+		
	2700K	3000K	3500K	4000K	5000K	2700K	3000K	3500K	4000K	5000K	5700K	6500K	3000K	4000K	5000K
LC003D Gen3	o	o	o	o	o	o	o	o	o	o	o	o			
LC006D Gen3	o	o	o	o	o	o	o	o	o	o	o	o			
LC009D Gen3	o	o	o	o	o	o	o	o	o	o	o	o	o	o	o
LC013D Gen3	o	o	o	o	o	o	o	o	o	o	o	o	o	o	o
LC016D Gen3	o	o	o	o	o	o	o	o	o	o	o	o	o	o	o
LC019D Gen3	o	o	o	o	o	o	o	o	o	o	o	o	o	o	o
LC026D Gen3	o	o	o	o	o	o	o	o	o	o	o	o	o	o	o
LC033D Gen3	o	o	o	o	o	o	o	o	o	o	o	o	o	o	o
LC040D Gen3	o	o	o	o	o	o	o	o	o	o	o	o	o	o	o
LC060D Gen3	o	o	o	o	o	o	o	o	o	o	o	o	o	o	o
LC080D Gen3	o	o	o	o	o	o	o	o	o	o	o	o	o	o	o
MacAdam 2-Step	o	o	o	o		o	o	o	o						
MacAdam 3-Step	o	o	o	o	o	o	o	o	o	o	o	o	o	o	o

## Specifications

Product	CRI	CCT (K)	Color rank	Part Number	T <sub>j</sub> = 85°C		I <sub>F</sub> (mA) V <sub>F</sub> (V)		
					Luminous Flux Typ. (lm)	Luminous Efficacy Typ. (lm/W)			
 LC003D Gen 3	80+	2700	MacAdam 2step	SPHWAHDNA25YZW2D3	475	156	90mA 33.8V		
			MacAdam 3step	SPHWAHDNA25YZW3D3					
		3000	MacAdam 2step	SPHWAHDNA25YZV2D3	499	164			
			MacAdam 3step	SPHWAHDNA25YZV3D3					
		3500	MacAdam 2step	SPHWAHDNA25YU2D3	514	169			
			MacAdam 3step	SPHWAHDNA25YU3D3					
		4000	MacAdam 2step	SPHWAHDNA25YT2D3	524	172			
			MacAdam 3step	SPHWAHDNA25YT3D3					
		5000	MacAdam 3step	SPHWAHDNA25YZR3D3	529	174			
			5700	MacAdam 3step				SPHWAHDNA25YZQ3D3	529
		6500	MacAdam 3step	SPHWAHDNA25YZP3D3	524	172			
		 LC003D Gen 3	90+	2700	MacAdam 2step	SPHWAHDNA27YZW2D3		407	134
MacAdam 3step	SPHWAHDNA27YZW3D3								
3000	MacAdam 2step			SPHWAHDNA27YZV2D3	428	141			
	MacAdam 3step			SPHWAHDNA27YZV3D3					
3500	MacAdam 2step			SPHWAHDNA27YU2D3	441	145			
	MacAdam 3step			SPHWAHDNA27YU3D3					
4000	MacAdam 2step			SPHWAHDNA27YT2D3	450	148			
	MacAdam 3step			SPHWAHDNA27YT3D3					
5000	MacAdam 3step			SPHWAHDNA27YZR3D3	453	149			
 LC006D Gen 3	80+			2700	MacAdam 2step	SPHWAHDNB25YZW2D3	946	155	180mA 33.8V
					MacAdam 3step	SPHWAHDNB25YZW3D3			
				3000	MacAdam 2step	SPHWAHDNB25YZV2D3	994	163	
		MacAdam 3step	SPHWAHDNB25YZV3D3						
		3500	MacAdam 2step	SPHWAHDNB25YU2D3	1023	168			
			MacAdam 3step	SPHWAHDNB25YU3D3					
		4000	MacAdam 2step	SPHWAHDNB25YT2D3	1043	171			
			MacAdam 3step	SPHWAHDNB25YT3D3					
		5000	MacAdam 3step	SPHWAHDNB25YZR3D3	1052	173			
		5700	MacAdam 3step	SPHWAHDNB25YZQ3D3	1052	173			
		6500	MacAdam 3step	SPHWAHDNB25YZP3D3	1043	171			
		 LC006D Gen 3	90+	2700	MacAdam 2step	SPHWAHDNB27YZW2D3	809	133	
MacAdam 3step	SPHWAHDNB27YZW3D3								
3000	MacAdam 2step			SPHWAHDNB27YZV2D3	851	140			
	MacAdam 3step			SPHWAHDNB27YZV3D3					
3500	MacAdam 2step			SPHWAHDNB27YU2D3	877	144			
	MacAdam 3step			SPHWAHDNB27YU3D3					
4000	MacAdam 2step			SPHWAHDNB27YT2D3	895	147			
	MacAdam 3step			SPHWAHDNB27YT3D3					
5000	MacAdam 3step			SPHWAHDNB27YZR3D3	902	148			

# Specifications

Product	CRI	CCT (K)	Color rank	Part Number	T <sub>j</sub> = 85°C		I <sub>F</sub> (mA) V <sub>F</sub> (V)			
					Luminous Flux Typ. (lm)	Luminous Efficacy Typ. (lm/W)				
 LC009D Gen 3	70+	3000	MacAdam 3step	SPHWAHDNC23YZV3D3	1594	174	270mA 33.8V			
		4000	MacAdam 3step	SPHWAHDNC23YZT3D3	1624	177				
		5000	MacAdam 3step	SPHWAHDNC23YZR3D3	1653	180				
	80+	2700	MacAdam 2step	SPHWAHDNC25YZW2D3	1405	154				
			MacAdam 3step	SPHWAHDNC25YZW3D3						
		3000	MacAdam 2step	SPHWAHDNC25YZV2D3	1476	162				
			MacAdam 3step	SPHWAHDNC25YZV3D3						
		3500	MacAdam 2step	SPHWAHDNC25YZU2D3	1519	166				
			MacAdam 3step	SPHWAHDNC25YZU3D3						
	4000	MacAdam 2step	SPHWAHDNC25YZT2D3	1550	170					
		MacAdam 3step	SPHWAHDNC25YZT3D3							
	90+	5000	MacAdam 3step	SPHWAHDNC25YZR3D3	1563	171				
			5700	MacAdam 3step				SPHWAHDNC25YZQ3D3	1563	171
			6500	MacAdam 3step				SPHWAHDNC25YZP3D3		
		2700	MacAdam 2step	SPHWAHDNC27YZW2D3	1202	132				
			MacAdam 3step	SPHWAHDNC27YZW3D3						
		3000	MacAdam 2step	SPHWAHDNC27YZV2D3	1264	139				
			MacAdam 3step	SPHWAHDNC27YZV3D3						
			MacAdam 2step	SPHWAHDNC27YZU2D3				1302	143	
		MacAdam 3step	SPHWAHDNC27YZU3D3							
		4000	MacAdam 2step	SPHWAHDNC27YZT2D3	1329	146				
			MacAdam 3step	SPHWAHDNC27YZT3D3						
		5000	MacAdam 3step	SPHWAHDNC27YZR3D3	1340	147				
	70+	3000	MacAdam 3step	SPHWAHDND23YZV3D3	2094	171				
4000			MacAdam 3step	SPHWAHDND23YZT3D3			2133	174		
5000			MacAdam 3step	SPHWAHDND23YZR3D3						
80+		2700	MacAdam 2step	SPHWAHDND35YZW2D3	1845	152				
			MacAdam 3step	SPHWAHDND35YZW3D3						
		3000	MacAdam 2step	SPHWAHDND35YZV2D3	1939	159				
			MacAdam 3step	SPHWAHDND35YZV3D3						
		3500	MacAdam 2step	SPHWAHDND35YZU2D3	1996	164				
			MacAdam 3step	SPHWAHDND35YZU3D3						
4000		MacAdam 2step	SPHWAHDND35YZT2D3	2036	167					
		MacAdam 3step	SPHWAHDND35YZT3D3							
90+		5000	MacAdam 3step	SPHWAHDND35YZR3D3	2053	169				
			5700	MacAdam 3step			SPHWAHDND35YZQ3D3	2053	169	
			6500	MacAdam 3step			SPHWAHDND35YZP3D3			
		2700	MacAdam 2step	SPHWAHDND37YZW2D3	1579	130				
			MacAdam 3step	SPHWAHDND37YZW3D3						
		3000	MacAdam 2step	SPHWAHDND37YZV2D3	1661	137				
MacAdam 3step			SPHWAHDND37YZV3D3							
MacAdam 2step	SPHWAHDND37YZU2D3		1710	141						
MacAdam 3step	SPHWAHDND37YZU3D3									
4000	MacAdam 2step	SPHWAHDND37YZT2D3	1745	143						
	MacAdam 3step	SPHWAHDND37YZT3D3								
5000	MacAdam 3step	SPHWAHDND37YZR3D3	1760	145						

Product	CRI	CCT (K)	Color rank	Part Number	T <sub>j</sub> = 85°C		I <sub>F</sub> (mA) V <sub>F</sub> (V)			
					Luminous Flux Typ. (lm)	Luminous Efficacy Typ. (lm/W)				
 LC016D Gen 3	70+	3000	MacAdam 3step	SPHWAHDNE23YZV3D3	2697	176	450mA 33.8V			
		4000	MacAdam 3step	SPHWAHDNE23YZT3D3	2747	180				
		5000	MacAdam 3step	SPHWAHDNE23YZR3D3	2797	183				
	80+	2700	MacAdam 2step	SPHWAHDNE25YZW2D3	2376	156				
			MacAdam 3step	SPHWAHDNE25YZW3D3						
		3000	MacAdam 2step	SPHWAHDNE25YZV2D3	2497	164				
			MacAdam 3step	SPHWAHDNE25YZV3D3						
		3500	MacAdam 2step	SPHWAHDNE25YZU2D3	2570	169				
			MacAdam 3step	SPHWAHDNE25YZU3D3						
	4000	MacAdam 2step	SPHWAHDNE25YZT2D3	2622	172					
		MacAdam 3step	SPHWAHDNE25YZT3D3							
	90+	5000	MacAdam 3step	SPHWAHDNE25YZR3D3	2644	174				
			5700	MacAdam 3step				SPHWAHDNE25YZQ3D3	2644	174
			6500	MacAdam 3step				SPHWAHDNE25YZP3D3		
		2700	MacAdam 2step	SPHWAHDNE27YZW2D3	2033	134				
			MacAdam 3step	SPHWAHDNE27YZW3D3						
		3000	MacAdam 2step	SPHWAHDNE27YZV2D3	2139	141				
			MacAdam 3step	SPHWAHDNE27YZV3D3						
			MacAdam 2step	SPHWAHDNE27YZU2D3				2203	145	
		MacAdam 3step	SPHWAHDNE27YZU3D3							
		4000	MacAdam 2step	SPHWAHDNE27YZT2D3	2248	148				
			MacAdam 3step	SPHWAHDNE27YZT3D3						
		5000	MacAdam 3step	SPHWAHDNE27YZR3D3	2267	149				
	70+	3000	MacAdam 3step	SPHWAHDNF23YZV3D3	3220	175				
4000			MacAdam 3step	SPHWAHDNF23YZT3D3			3280	179		
5000			MacAdam 3step	SPHWAHDNF23YZR3D3						
80+		2700	MacAdam 2step	SPHWAHDNF25YZW2D3	2837	155				
			MacAdam 3step	SPHWAHDNF25YZW3D3						
		3000	MacAdam 2step	SPHWAHDNF25YZV2D3	2982	163				
			MacAdam 3step	SPHWAHDNF25YZV3D3						
		3500	MacAdam 2step	SPHWAHDNF25YZU2D3	3069	168				
			MacAdam 3step	SPHWAHDNF25YZU3D3						
4000		MacAdam 2step	SPHWAHDNF25YZT2D3	3130	171					
		MacAdam 3step	SPHWAHDNF25YZT3D3							
90+		5000	MacAdam 3step	SPHWAHDNF25YZR3D3	3157	173				
			5700	MacAdam 3step			SPHWAHDNF25YZQ3D3	3157	173	
			6500	MacAdam 3step			SPHWAHDNF25YZP3D3			
		2700	MacAdam 2step	SPHWAHDNF27YZW2D3	2428	133				
			MacAdam 3step	SPHWAHDNF27YZW3D3						
		3000	MacAdam 2step	SPHWAHDNF27YZV2D3	2554	140				
MacAdam 3step			SPHWAHDNF27YZV3D3							
MacAdam 2step	SPHWAHDNF27YZU2D3		2630	144						
MacAdam 3step	SPHWAHDNF27YZU3D3									
4000	MacAdam 2step	SPHWAHDNF27YZT2D3	2684	147						
	MacAdam 3step	SPHWAHDNF27YZT3D3								
5000	MacAdam 3step	SPHWAHDNF27YZR3D3	2707	148						

# Specifications

Product	CRI	CCT (K)	Color rank	Part Number	T <sub>j</sub> = 85°C		I <sub>F</sub> (mA) V <sub>F</sub> (V)
					Luminous Flux Typ. (lm)	Luminous Efficacy Typ. (lm/W)	
 LC026D Gen 3	70+	3000	MacAdam 3step	SPHWAHDNG23YZV3D3	4230	174	720mA 33.8V
		4000	MacAdam 3step	SPHWAHDNG23YZT3D3	4308	177	
		5000	MacAdam 3step	SPHWAHDNG23YZR3D3	4387	180	
	80+	2700	MacAdam 2step	SPHWAHDNG25YZW2D3	3727	153	
			MacAdam 3step	SPHWAHDNG25YZW3D3			
		3000	MacAdam 2step	SPHWAHDNG25YZV2D3	3917	161	
			MacAdam 3step	SPHWAHDNG25YZV3D3			
		3500	MacAdam 2step	SPHWAHDNG25YZU2D3	4032	166	
			MacAdam 3step	SPHWAHDNG25YZU3D3			
		4000	MacAdam 2step	SPHWAHDNG25YZT2D3	4112	169	
			MacAdam 3step	SPHWAHDNG25YZT3D3			
		5000	MacAdam 3step	SPHWAHDNG25YZR3D3	4147	170	
			MacAdam 3step	SPHWAHDNG25YZQ3D3			
		6500	MacAdam 3step	SPHWAHDNG25YZP3D3	4112	169	
			MacAdam 3step	SPHWAHDNG25YZP3D3			
	90+	2700	MacAdam 2step	SPHWAHDNG27YZW2D3	3190	131	
			MacAdam 3step	SPHWAHDNG27YZW3D3			
		3000	MacAdam 2step	SPHWAHDNG27YZV2D3	3355	138	
			MacAdam 3step	SPHWAHDNG27YZV3D3			
		3500	MacAdam 2step	SPHWAHDNG27YZU2D3	3455	142	
			MacAdam 3step	SPHWAHDNG27YZU3D3			
4000		MacAdam 2step	SPHWAHDNG27YZT2D3	3526	145		
		MacAdam 3step	SPHWAHDNG27YZT3D3				
5000		MacAdam 3step	SPHWAHDNG27YZR3D3	3556	146		
	MacAdam 3step	SPHWAHDNG27YZR3D3					
70+	3000	MacAdam 3step	SPHWAHDNH23YZV3D3	5235	172		
	4000	MacAdam 3step	SPHWAHDNH23YZT3D3	5332	175		
	5000	MacAdam 3step	SPHWAHDNH23YZR3D3	5429	178		
	2700	MacAdam 2step	SPHWAHDNH25YZW2D3	4612	152		
		MacAdam 3step	SPHWAHDNH25YZW3D3				
	3000	MacAdam 2step	SPHWAHDNH25YZV2D3	4847	159		
MacAdam 3step		SPHWAHDNH25YZV3D3					
80+	3500	MacAdam 2step	SPHWAHDNH25YZU2D3	4989	164		
		MacAdam 3step	SPHWAHDNH25YZU3D3				
	4000	MacAdam 2step	SPHWAHDNH25YZT2D3	5089	167		
		MacAdam 3step	SPHWAHDNH25YZT3D3				
	5000	MacAdam 3step	SPHWAHDNH25YZR3D3	5132	169		
	5700	MacAdam 3step	SPHWAHDNH25YZQ3D3	5132	169		
	6500	MacAdam 3step	SPHWAHDNH25YZP3D3	5089	167		

Product	CRI	CCT (K)	Color rank	Part Number	T <sub>j</sub> = 85°C		I <sub>F</sub> (mA) V <sub>F</sub> (V)
					Luminous Flux Typ. (lm)	Luminous Efficacy Typ. (lm/W)	
 LC033D Gen 3	90+	2700	MacAdam 2step	SPHWAHDNH27YZW2D3	3947	130	900mA 33.8V
			MacAdam 3step	SPHWAHDNH27YZW3D3			
		3000	MacAdam 2step	SPHWAHDNH27YZV2D3	4152	136	
			MacAdam 3step	SPHWAHDNH27YZV3D3			
		3500	MacAdam 2step	SPHWAHDNH27YZU2D3	4276	141	
			MacAdam 3step	SPHWAHDNH27YZU3D3			
	4000	MacAdam 2step	SPHWAHDNH27YZT2D3	4364	143		
		MacAdam 3step	SPHWAHDNH27YZT3D3				
	70+	3000	MacAdam 3step	SPHWAHDNK23YZV3D3	6440	176	
			MacAdam 3step	SPHWAHDNK23YZT3D3	6560	180	
			MacAdam 3step	SPHWAHDNK23YZR3D3	6679	183	
		2700	MacAdam 2step	SPHWAHDNK25YZW2D3	5675	155	
MacAdam 3step			SPHWAHDNK25YZW3D3				
MacAdam 2step			SPHWAHDNK25YZV2D3	5963			163
3000	MacAdam 3step	SPHWAHDNK25YZV3D3	6138	168			
	MacAdam 2step	SPHWAHDNK25YZU2D3					
	MacAdam 3step	SPHWAHDNK25YZU3D3					
4000	MacAdam 2step	SPHWAHDNK25YZT2D3	6261	172			
	MacAdam 3step	SPHWAHDNK25YZT3D3					
	MacAdam 3step	SPHWAHDNK25YZR3D3			6313	173	
5000	MacAdam 3step	SPHWAHDNK25YZQ3D3	6313	173			
	MacAdam 3step	SPHWAHDNK25YZP3D3	6261	172			
	MacAdam 3step	SPHWAHDNK25YZP3D3	6261	172			
80+	2700	MacAdam 2step	SPHWAHDNK27YZW2D3	4856	133		
		MacAdam 3step	SPHWAHDNK27YZW3D3				
	3000	MacAdam 2step	SPHWAHDNK27YZV2D3	5108	140		
		MacAdam 3step	SPHWAHDNK27YZV3D3				
	3500	MacAdam 2step	SPHWAHDNK27YZU2D3	5260	144		
		MacAdam 3step	SPHWAHDNK27YZU3D3				
4000	MacAdam 2step	SPHWAHDNK27YZT2D3	5369	147			
	MacAdam 3step	SPHWAHDNK27YZT3D3					
5000	MacAdam 3step	SPHWAHDNK27YZR3D3	5415	148			
90+	3500	MacAdam 2step	SPHWAHDNK27YZU2D3	5260	144		
		MacAdam 3step	SPHWAHDNK27YZU3D3				
	4000	MacAdam 2step	SPHWAHDNK27YZT2D3	5369	147		
		MacAdam 3step	SPHWAHDNK27YZT3D3				
	5000	MacAdam 3step	SPHWAHDNK27YZR3D3	5415	148		
		MacAdam 3step	SPHWAHDNK27YZR3D3				
5000	MacAdam 3step	SPHWAHDNK27YZR3D3	5415	148			

# Specifications

Product	CRI	CCT (K)	Color rank	Part Number	T <sub>j</sub> = 85°C		I <sub>F</sub> (mA) V <sub>F</sub> (V)
					Luminous Flux Typ. (lm)	Luminous Efficacy Typ. (lm/W)	
 LC060D Gen 3	70+	3000	MacAdam 3step	SPHWAHDNL231ZV3D3	9518	174	1080mA 50.7V
		4000	MacAdam 3step	SPHWAHDNL231ZT3D3	9694	177	
		5000	MacAdam 3step	SPHWAHDNL231ZR3D3	9870	180	
	2700	MacAdam 2step	SPHWAHDNL251ZW2D3	8386	153		
		MacAdam 3step	SPHWAHDNL251ZW3D3				
	3000	MacAdam 2step	SPHWAHDNL251ZV2D3	8813	161		
		MacAdam 3step	SPHWAHDNL251ZV3D3				
	3500	MacAdam 2step	SPHWAHDNL251ZU2D3	9071	166		
		MacAdam 3step	SPHWAHDNL251ZU3D3				
	4000	MacAdam 2step	SPHWAHDNL251ZT2D3	9253	169		
		MacAdam 3step	SPHWAHDNL251ZT3D3				
	5000	MacAdam 3step	SPHWAHDNL251ZR3D3	9330	170		
	5700	MacAdam 3step	SPHWAHDNL251ZQ3D3	9330	170		
	6500	MacAdam 3step	SPHWAHDNL251ZP3D3	9253	169		
	2700	MacAdam 2step	SPHWAHDNL271ZW2D3	7177	131		
		MacAdam 3step	SPHWAHDNL271ZW3D3				
	3000	MacAdam 2step	SPHWAHDNL271ZV2D3	7549	138		
		MacAdam 3step	SPHWAHDNL271ZV3D3				
	3500	MacAdam 2step	SPHWAHDNL271ZU2D3	7774	142		
		MacAdam 3step	SPHWAHDNL271ZU3D3				
4000	MacAdam 2step	SPHWAHDNL271ZT2D3	7934	145			
	MacAdam 3step	SPHWAHDNL271ZT3D3					
5000	MacAdam 3step	SPHWAHDNL271ZR3D3	8002	146			

Product	CRI	CCT (K)	Color rank	Part Number	T <sub>j</sub> = 85°C		I <sub>F</sub> (mA) V <sub>F</sub> (V)
					Luminous Flux Typ. (lm)	Luminous Efficacy Typ. (lm/W)	
 LC080D Gen 3	70+	3000	MacAdam 3step	SPHWAHDNM231ZV3D3	14115	172	1620mA 50.7V
		4000	MacAdam 3step	SPHWAHDNM231ZT3D3	14376	175	
		5000	MacAdam 3step	SPHWAHDNM231ZR3D3	14637	178	
	2700	MacAdam 2step	SPHWAHDNM251ZW2D3	12437	151		
		MacAdam 3step	SPHWAHDNM251ZW3D3				
	3000	MacAdam 2step	SPHWAHDNM251ZV2D3	13069	159		
		MacAdam 3step	SPHWAHDNM251ZV3D3				
	3500	MacAdam 2step	SPHWAHDNM251ZU2D3	13452	164		
		MacAdam 3step	SPHWAHDNM251ZU3D3				
	4000	MacAdam 2step	SPHWAHDNM251ZT2D3	13721	167		
		MacAdam 3step	SPHWAHDNM251ZT3D3				
	5000	MacAdam 3step	SPHWAHDNM251ZR3D3	13836	168		
	5700	MacAdam 3step	SPHWAHDNM251ZQ3D3	13836	168		
	6500	MacAdam 3step	SPHWAHDNM251ZP3D3	13721	167		
	2700	MacAdam 2step	SPHWAHDNM271ZW2D3	10643	130		
		MacAdam 3step	SPHWAHDNM271ZW3D3				
	3000	MacAdam 2step	SPHWAHDNM271ZV2D3	11195	136		
		MacAdam 3step	SPHWAHDNM271ZV3D3				
	3500	MacAdam 2step	SPHWAHDNM271ZU2D3	11529	140		
		MacAdam 3step	SPHWAHDNM271ZU3D3				
4000	MacAdam 2step	SPHWAHDNM271ZT2D3	11766	143			
	MacAdam 3step	SPHWAHDNM271ZT3D3					
5000	MacAdam 3step	SPHWAHDNM271ZR3D3	11867	144			

# D-series Gen 2

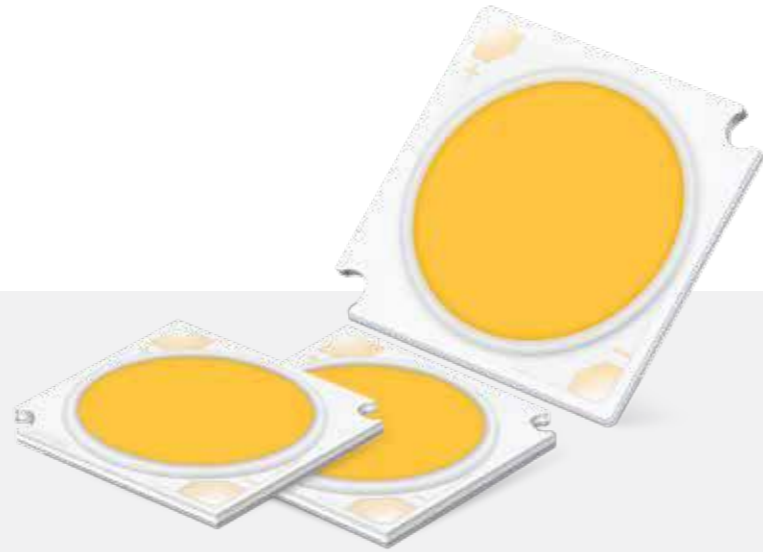

T <sub>j</sub> =85°C	LC003D Gen 2	LC006D Gen 2	LC009D Gen 2	LC013D Gen 2	LC016D Gen 2	LC019D Gen 2	LC026D Gen 2	LC033D Gen 2	LC040D Gen 2	LC060D Gen 2	LC080D Gen 2	
LES	9.8mm			14.5mm				22 mm				
Typical	34.6 V								52 V			
	3.1 W (90 mA)	6.2 W (180 mA)	9.4 W (270 mA)	12.5 W (360 mA)	15.6 W (450 mA)	18.7 W (540 mA)	24.9 W (720 mA)	31.1 W (900 mA)	37.4 W (1080 mA)	56.1 W (1080 mA)	84.2 W (1620 mA)	
Max.	8.6 W (230 mA)	17.2 W (460 mA)	25.9 W (690 mA)	34.5 W (920 mA)	43.1 W (1150 mA)	51.8 W (1380 mA)	69 W (1840 mA)	86.2 W (2300 mA)	103.5 W (2760 mA)	143.4 W (2760 mA)	215 W (4140 mA)	
Size	13.5mm x 13.5mm			19mm x 19mm				28mm x 28mm				

## Color Variation

※ CRI: Minimum

Product	CRI90+					CRI80+							CRI70+		
	2700K	3000K	3500K	4000K	5000K	2700K	3000K	3500K	4000K	5000K	5700K	6500K	3000K	4000K	5000K
LC003D Gen2	o	o	o	o	o	o	o	o	o	o	o	o			
LC006D Gen2	o	o	o	o	o	o	o	o	o	o	o	o			
LC009D Gen2	o	o	o	o	o	o	o	o	o	o	o	o	o	o	o
LC013D Gen2	o	o	o	o	o	o	o	o	o	o	o	o	o	o	o
LC016D Gen2	o	o	o	o	o	o	o	o	o	o	o	o	o	o	o
LC019D Gen2	o	o	o	o	o	o	o	o	o	o	o	o	o	o	o
LC026D Gen2	o	o	o	o	o	o	o	o	o	o	o	o	o	o	o
LC033D Gen2	o	o	o	o	o	o	o	o	o	o	o	o	o	o	o
LC040D Gen2	o	o	o	o	o	o	o	o	o	o	o	o	o	o	o
LC060D Gen2	o	o	o	o	o	o	o	o	o	o	o	o	o	o	o
LC080D Gen2	o	o	o	o	o	o	o	o	o	o	o	o	o	o	o
MacAdam 2-Step	o	o	o	o		o	o	o	o						
MacAdam 3-Step	o	o	o	o	o	o	o	o	o	o	o	o	o	o	o

## Specifications

Product	CRI	CCT (K)	Color rank	Part Number	T <sub>j</sub> = 85°C		I <sub>F</sub> (mA) V <sub>F</sub> (V)
					Luminous Flux Typ. (lm)	Luminous Efficacy Typ. (lm/W)	
 LC003D Gen 2	80+	2700	MacAdam 2step	SPHWAHDNA25YZW2D2	459	147	90mA 34.6V
			MacAdam 3step	SPHWAHDNA25YZW3D2			
		3000	MacAdam 2step	SPHWAHDNA25YZV2D2	483	155	
			MacAdam 3step	SPHWAHDNA25YZV3D2			
		3500	MacAdam 2step	SPHWAHDNA25YU2D2	501	161	
			MacAdam 3step	SPHWAHDNA25YU3D2			
		4000	MacAdam 2step	SPHWAHDNA25YT2D2	507	163	
			MacAdam 3step	SPHWAHDNA25YT3D2			
		5000	MacAdam 3step	SPHWAHDNA25YZR3D2	513	165	
		5700	MacAdam 3step	SPHWAHDNA25YZQ3D2	513	165	
		6500	MacAdam 3step	SPHWAHDNA25YZP3D2	507	163	
		90+	2700	MacAdam 2step	SPHWAHDNA27YZW2D2	388	
MacAdam 3step	SPHWAHDNA27YZW3D2						
3000	MacAdam 2step		SPHWAHDNA27YZV2D2	406	130		
	MacAdam 3step		SPHWAHDNA27YZV3D2				
3500	MacAdam 2step		SPHWAHDNA27YU2D2	419	135		
	MacAdam 3step		SPHWAHDNA27YU3D2				
4000	MacAdam 2step		SPHWAHDNA27YT2D2	427	137		
	MacAdam 3step		SPHWAHDNA27YT3D2				
5000	MacAdam 3step		SPHWAHDNA27YZR3D2	430	138		
80+	2700		MacAdam 2step	SPHWAHDNB25YZW2D2	924	148	180mA 34.6V
			MacAdam 3step	SPHWAHDNB25YZW3D2			
	3000		MacAdam 2step	SPHWAHDNB25YZV2D2	971	156	
		MacAdam 3step	SPHWAHDNB25YZV3D2				
	3500	MacAdam 2step	SPHWAHDNB25YU2D2	1001	161		
		MacAdam 3step	SPHWAHDNB25YU3D2				
	4000	MacAdam 2step	SPHWAHDNB25YT2D2	1024	164		
		MacAdam 3step	SPHWAHDNB25YT3D2				
	5000	MacAdam 3step	SPHWAHDNB25YZR3D2	1030	165		
	5700	MacAdam 3step	SPHWAHDNB25YZQ3D2	1030	165		
	6500	MacAdam 3step	SPHWAHDNB25YZP3D2	1018	163		
	90+	2700	MacAdam 2step	SPHWAHDNB27YZW2D2	786	126	
MacAdam 3step			SPHWAHDNB27YZW3D2				
3000		MacAdam 2step	SPHWAHDNB27YZV2D2	824	132		
		MacAdam 3step	SPHWAHDNB27YZV3D2				
3500		MacAdam 2step	SPHWAHDNB27YU2D2	853	137		
		MacAdam 3step	SPHWAHDNB27YU3D2				
4000		MacAdam 2step	SPHWAHDNB27YT2D2	870	140		
		MacAdam 3step	SPHWAHDNB27YT3D2				
5000		MacAdam 3step	SPHWAHDNB27YZR3D2	874	140		

# Specifications

Product	CRI	CCT (K)	Color rank	Part Number	T <sub>j</sub> = 85°C		I <sub>F</sub> (mA) V <sub>F</sub> (V)
					Luminous Flux Typ. (lm)	Luminous Efficacy Typ. (lm/W)	
 LC009D Gen 2	70+	3000	MacAdam 3step	SPHWAHDNC23YZV3D2	1578	161	270mA 34.6V
		4000	MacAdam 3step	SPHWAHDNC23YZT3D2	1654	169	
		5000	MacAdam 3step	SPHWAHDNC23YZR3D2	1707	174	
	80+	2700	MacAdam 2step	SPHWAHDNC25YZW2D2	1342	144	
			MacAdam 3step	SPHWAHDNC25YZW3D2			
		3000	MacAdam 2step	SPHWAHDNC25YZV2D2	1418	152	
			MacAdam 3step	SPHWAHDNC25YZV3D2			
		3500	MacAdam 2step	SPHWAHDNC25YZU2D2	1459	156	
			MacAdam 3step	SPHWAHDNC25YZU3D2			
	90+	4000	MacAdam 2step	SPHWAHDNC25YZT2D2	1494	160	
			MacAdam 3step	SPHWAHDNC25YZT3D2			
		5000	MacAdam 3step	SPHWAHDNC25YZR3D2	1506	161	
			MacAdam 3step	SPHWAHDNC25YZQ3D2	1506	161	
			MacAdam 3step	SPHWAHDNC25YZP3D2	1488	159	
	90+	2700	MacAdam 2step	SPHWAHDNC27YZW2D2	1152	123	
			MacAdam 3step	SPHWAHDNC27YZW3D2			
		3000	MacAdam 2step	SPHWAHDNC27YZV2D2	1206	129	
			MacAdam 3step	SPHWAHDNC27YZV3D2			
		3500	MacAdam 2step	SPHWAHDNC27YZU2D2	1245	133	
			MacAdam 3step	SPHWAHDNC27YZU3D2			
		4000	MacAdam 2step	SPHWAHDNC27YZT2D2	1273	136	
MacAdam 3step			SPHWAHDNC27YZT3D2				
MacAdam 3step			SPHWAHDNC27YZR3D2	1278			137
70+		3000	MacAdam 3step	SPHWAHDND23YZV3D2	2106	161	
	MacAdam 3step		SPHWAHDND23YZT3D2	2173	166		
	MacAdam 3step		SPHWAHDND23YZR3D2	2207	169		
	80+	2700	MacAdam 2step	SPHWAHDND25YZW2D2	1764	142	
			MacAdam 3step	SPHWAHDND25YZW3D2			
		3000	MacAdam 2step	SPHWAHDND25YZV2D2	1857	149	
			MacAdam 3step	SPHWAHDND25YZV3D2			
	3500	MacAdam 2step	SPHWAHDND25YZU2D2	1915	154		
		MacAdam 3step	SPHWAHDND25YZU3D2				
		4000	MacAdam 2step			SPHWAHDND25YZT2D2	1950
	MacAdam 3step		SPHWAHDND25YZT3D2				
	90+	5000	MacAdam 3step	SPHWAHDND25YZR3D2	1967	158	
			MacAdam 3step	SPHWAHDND25YZQ3D2	1967	158	
			MacAdam 3step	SPHWAHDND25YZP3D2	1938	156	
		2700	MacAdam 2step	SPHWAHDND27YZW2D2	1509	121	
MacAdam 3step			SPHWAHDND27YZW3D2				
90+	3000	MacAdam 2step	SPHWAHDND27YZV2D2	1580	127		
		MacAdam 3step	SPHWAHDND27YZV3D2				
	3500	MacAdam 2step	SPHWAHDND27YZU2D2	1635	131		
		MacAdam 3step	SPHWAHDND27YZU3D2				
	4000	MacAdam 2step	SPHWAHDND27YZT2D2	1670	134		
		MacAdam 3step	SPHWAHDND27YZT3D2				
		MacAdam 3step	SPHWAHDND27YZR3D2			1674	134

Product	CRI	CCT (K)	Color rank	Part Number	T <sub>j</sub> = 85°C		I <sub>F</sub> (mA) V <sub>F</sub> (V)
					Luminous Flux Typ. (lm)	Luminous Efficacy Typ. (lm/W)	
 LC016D Gen 2	70+	3000	MacAdam 3step	SPHWAHDNE23YZV3D2	2617	168	450mA 34.6V
		4000	MacAdam 3step	SPHWAHDNE23YZT3D2	2701	173	
		5000	MacAdam 3step	SPHWAHDNE23YZR3D2	2742	176	
	80+	2700	MacAdam 2step	SPHWAHDNE25YZW2D2	2293	147	
			MacAdam 3step	SPHWAHDNE25YZW3D2			
		3000	MacAdam 2step	SPHWAHDNE25YZV2D2	2423	156	
			MacAdam 3step	SPHWAHDNE25YZV3D2			
		3500	MacAdam 2step	SPHWAHDNE25YZU2D2	2513	161	
			MacAdam 3step	SPHWAHDNE25YZU3D2			
	90+	4000	MacAdam 2step	SPHWAHDNE25YZT2D2	2558	164	
			MacAdam 3step	SPHWAHDNE25YZT3D2			
		5000	MacAdam 3step	SPHWAHDNE25YZR3D2	2581	166	
			MacAdam 3step	SPHWAHDNE25YZQ3D2	2581	166	
			MacAdam 3step	SPHWAHDNE25YZP3D2	2558	164	
	90+	2700	MacAdam 2step	SPHWAHDNE27YZW2D2	1967	126	
			MacAdam 3step	SPHWAHDNE27YZW3D2			
		3000	MacAdam 2step	SPHWAHDNE27YZV2D2	2084	134	
			MacAdam 3step	SPHWAHDNE27YZV3D2			
		3500	MacAdam 2step	SPHWAHDNE27YZU2D2	2146	138	
			MacAdam 3step	SPHWAHDNE27YZU3D2			
		4000	MacAdam 2step	SPHWAHDNE27YZT2D2	2189	141	
MacAdam 3step			SPHWAHDNE27YZT3D2				
MacAdam 3step			SPHWAHDNE27YZR3D2	2209			142
70+		3000	MacAdam 3step	SPHWAHDNF23YZV3D2	3107	166	
	MacAdam 3step		SPHWAHDNF23YZT3D2	3207	172		
	MacAdam 3step		SPHWAHDNF23YZR3D2	3256	174		
	80+	2700	MacAdam 2step	SPHWAHDNF25YZW2D2	2728	146	
			MacAdam 3step	SPHWAHDNF25YZW3D2			
		3000	MacAdam 2step	SPHWAHDNF25YZV2D2	2877	154	
			MacAdam 3step	SPHWAHDNF25YZV3D2			
	3500	MacAdam 2step	SPHWAHDNF25YZU2D2	2965	159		
		MacAdam 3step	SPHWAHDNF25YZU3D2				
		4000	MacAdam 2step			SPHWAHDNF25YZT2D2	3026
	MacAdam 3step		SPHWAHDNF25YZT3D2				
	90+	5000	MacAdam 3step	SPHWAHDNF25YZR3D2	3059	164	
			MacAdam 3step	SPHWAHDNF25YZQ3D2	3059	164	
			MacAdam 3step	SPHWAHDNF25YZP3D2	3026	162	
		2700	MacAdam 2step	SPHWAHDNF27YZW2D2	2336	125	
MacAdam 3step			SPHWAHDNF27YZW3D2				
90+	3000	MacAdam 2step	SPHWAHDNF27YZV2D2	2449	131		
		MacAdam 3step	SPHWAHDNF27YZV3D2				
	3500	MacAdam 2step	SPHWAHDNF27YZU2D2	2539	136		
		MacAdam 3step	SPHWAHDNF27YZU3D2				
	4000	MacAdam 2step	SPHWAHDNF27YZT2D2	2594	139		
		MacAdam 3step	SPHWAHDNF27YZT3D2				
		MacAdam 3step	SPHWAHDNF27YZR3D2			2596	139





# Specifications

Product	CRI	CCT (K)	Color rank	Part Number	T <sub>j</sub> = 85°C		I <sub>F</sub> (mA) V <sub>F</sub> (V)
					Luminous Flux Typ. (lm)	Luminous Efficacy Typ. (lm/W)	
 LC026D Gen 2	70+	3000	MacAdam 3step	SPHWAHDNG23YZV3D2	4063	163	720mA 34.6V
		4000	MacAdam 3step	SPHWAHDNG23YZT3D2	4193	168	
		5000	MacAdam 3step	SPHWAHDNG23YZR3D2	4258	171	
	80+	2700	MacAdam 2step	SPHWAHDNG25YZW2D2	3580	144	
			MacAdam 3step	SPHWAHDNG25YZW3D2			
		3000	MacAdam 2step	SPHWAHDNG25YZV2D2	3762	151	
			MacAdam 3step	SPHWAHDNG25YZV3D2			
		3500	MacAdam 2step	SPHWAHDNG25YZU2D2	3872	155	
			MacAdam 3step	SPHWAHDNG25YZU3D2			
	4000	MacAdam 2step	SPHWAHDNG25YZT2D2	3950	159		
		MacAdam 3step	SPHWAHDNG25YZT3D2				
	90+	5000	MacAdam 3step	SPHWAHDNG25YZR3D2	3983	160	
		5700	MacAdam 3step	SPHWAHDNG25YZQ3D2	3983	160	
		6500	MacAdam 3step	SPHWAHDNG25YZP3D2	3950	159	
		2700	MacAdam 2step	SPHWAHDNG27YZW2D2	3064	123	
			MacAdam 3step	SPHWAHDNG27YZW3D2			
	3000	MacAdam 2step	SPHWAHDNG27YZV2D2	3223	129		
		MacAdam 3step	SPHWAHDNG27YZV3D2				
		MacAdam 3step	SPHWAHDNG27YZV3D2				
	3500	MacAdam 2step	SPHWAHDNG27YZU2D2	3319	133		
		MacAdam 3step	SPHWAHDNG27YZU3D2				
MacAdam 3step		SPHWAHDNG27YZU3D2					
4000	MacAdam 2step	SPHWAHDNG27YZT2D2	3387	136			
	MacAdam 3step	SPHWAHDNG27YZT3D2					
	MacAdam 3step	SPHWAHDNG27YZT3D2					
5000	MacAdam 3step	SPHWAHDNG27YZR3D2	3416	137			
	70+	3000	MacAdam 3step	SPHWAHDNG23YZV3D2	5014	161	900mA 34.6V
		4000	MacAdam 3step	SPHWAHDNG23YZT3D2	5175	166	
5000		MacAdam 3step	SPHWAHDNG23YZR3D2	5255	169		
80+	2700	MacAdam 2step	SPHWAHDNH25YZW2D2	4418	142		
		MacAdam 3step	SPHWAHDNH25YZW3D2				
	3000	MacAdam 2step	SPHWAHDNH25YZV2D2	4643	149		
		MacAdam 3step	SPHWAHDNH25YZV3D2				
	3500	MacAdam 2step	SPHWAHDNH25YZU2D2	4779	153		
		MacAdam 3step	SPHWAHDNH25YZU3D2				
4000	MacAdam 2step	SPHWAHDNH25YZT2D2	4875	157			
	MacAdam 3step	SPHWAHDNH25YZT3D2					
90+	5000	MacAdam 3step	SPHWAHDNH25YZR3D2	4916	158		
	5700	MacAdam 3step	SPHWAHDNH25YZQ3D2	4916	158		
	6500	MacAdam 3step	SPHWAHDNH25YZP3D2	4875	157		
	2700	MacAdam 2step	SPHWAHDNH27YZW2D2	3781	121		
		MacAdam 3step	SPHWAHDNH27YZW2D2				
3000	MacAdam 2step	SPHWAHDNH27YZV2D2	3977	128			
	MacAdam 3step	SPHWAHDNH27YZV3D2					
	MacAdam 3step	SPHWAHDNH27YZV3D2					
3500	MacAdam 2step	SPHWAHDNH27YZU2D2	4096	132			
	MacAdam 3step	SPHWAHDNH27YZU3D2					
	MacAdam 3step	SPHWAHDNH27YZU3D2					
4000	MacAdam 2step	SPHWAHDNH27YZT2D2	4180	134			
	MacAdam 3step	SPHWAHDNH27YZT2D2					
	MacAdam 3step	SPHWAHDNH27YZT2D2					
5000	MacAdam 3step	SPHWAHDNH27YZR3D2	4216	135			

Product	CRI	CCT (K)	Color rank	Part Number	T <sub>j</sub> = 85°C		I <sub>F</sub> (mA) V <sub>F</sub> (V)
					Luminous Flux Typ. (lm)	Luminous Efficacy Typ. (lm/W)	
 LC040D Gen 2	70+	3000	MacAdam 3step	SPHWAHDNK23YZV3D2	6304	169	1080mA 34.6V
		4000	MacAdam 3step	SPHWAHDNK23YZT3D2	6506	174	
		5000	MacAdam 3step	SPHWAHDNK23YZR3D2	6607	177	
	80+	2700	MacAdam 2step	SPHWAHDNK25YZW2D2	5547	148	
			MacAdam 3step	SPHWAHDNK25YZW3D2			
		3000	MacAdam 2step	SPHWAHDNK25YZV2D2	5837	156	
			MacAdam 3step	SPHWAHDNK25YZV3D2			
		3500	MacAdam 2step	SPHWAHDNK25YZU2D2	6016	161	
			MacAdam 3step	SPHWAHDNK25YZU3D2			
	4000	MacAdam 2step	SPHWAHDNK25YZT2D2	6146	164		
		MacAdam 3step	SPHWAHDNK25YZT3D2				
	5000	MacAdam 3step	SPHWAHDNK25YZR3D2	6175	165		
		5700	MacAdam 3step	SPHWAHDNK25YZQ3D2	6205	166	
		6500	MacAdam 3step	SPHWAHDNK25YZP3D2	6138	164	
	90+	2700	MacAdam 2step	SPHWAHDNK27YZW2D2	4755	127	
			MacAdam 3step	SPHWAHDNK27YZW3D2			
		3000	MacAdam 2step	SPHWAHDNK27YZV2D2	5024	134	
			MacAdam 3step	SPHWAHDNK27YZV3D2			
		3500	MacAdam 2step	SPHWAHDNK27YZU2D2	5152	138	
			MacAdam 3step	SPHWAHDNK27YZU3D2			
	4000	MacAdam 2step	SPHWAHDNK27YZT2D2	5266	141		
MacAdam 3step		SPHWAHDNK27YZT3D2					
MacAdam 3step		SPHWAHDNK27YZT3D2					
5000	MacAdam 3step	SPHWAHDNK27YZR3D2	5325	143			

# Specifications

Product	CRI	CCT (K)	Color rank	Part Number	T <sub>j</sub> = 85°C		I <sub>F</sub> (mA) V <sub>F</sub> (V)
					Luminous Flux Typ. (lm)	Luminous Efficacy Typ. (lm/W)	
 LC060D Gen 2	70+	3000	MacAdam 3step	SPHWAHDNL231ZV3D2	9225	164	1080mA 52V
		4000	MacAdam 3step	SPHWAHDNL231ZT3D2	9521	170	
		5000	MacAdam 3step	SPHWAHDNL231ZR3D2	9668	172	
	80+	2700	MacAdam 2step	SPHWAHDNL251ZW2D2	8107	144	
			MacAdam 3step	SPHWAHDNL251ZW3D2			
		3000	MacAdam 2step	SPHWAHDNL251ZV2D2	8542	152	
	MacAdam 3step	SPHWAHDNL251ZV3D2					
	80+	3500	MacAdam 2step	SPHWAHDNL251ZU2D2	8812	157	
			MacAdam 3step	SPHWAHDNL251ZU3D2			
		4000	MacAdam 2step	SPHWAHDNL251ZT2D2	8995	160	
	MacAdam 3step	SPHWAHDNL251ZT3D2					
	5000	MacAdam 3step	SPHWAHDNL251ZR3D2	9039	161		
	5700	MacAdam 3step	SPHWAHDNL251ZQ3D2	9084	162		
	6500	MacAdam 3step	SPHWAHDNL251ZP3D2	8990	160		
	90+	2700	MacAdam 2step	SPHWAHDNL271ZW2D2	6959	124	
			MacAdam 3step	SPHWAHDNL271ZW3D2			
		3000	MacAdam 2step	SPHWAHDNL271ZV2D2	7352	131	
			MacAdam 3step	SPHWAHDNL271ZV3D2			
		3500	MacAdam 2step	SPHWAHDNL271ZU2D2	7539	134	
			MacAdam 3step	SPHWAHDNL271ZU3D2			
4000		MacAdam 2step	SPHWAHDNL271ZT2D2	7706	137		
		MacAdam 3step	SPHWAHDNL271ZT3D2				
		5000	MacAdam 3step			SPHWAHDNL271ZR3D2	7793

Product	CRI	CCT (K)	Color rank	Part Number	T <sub>j</sub> = 85°C		I <sub>F</sub> (mA) V <sub>F</sub> (V)
					Luminous Flux Typ. (lm)	Luminous Efficacy Typ. (lm/W)	
 LC080D Gen 2	70+	3000	MacAdam 3step	SPHWAHDNM231ZV3D2	13465	160	1620mA 52V
		4000	MacAdam 3step	SPHWAHDNM231ZT3D2	13896	165	
		5000	MacAdam 3step	SPHWAHDNM231ZR3D2	14112	168	
	80+	2700	MacAdam 2step	SPHWAHDNM251ZW2D2	11815	140	
			MacAdam 3step	SPHWAHDNM251ZW3D2			
		3000	MacAdam 2step	SPHWAHDNM251ZV2D2	12468	148	
	MacAdam 3step	SPHWAHDNM251ZV3D2					
	80+	3500	MacAdam 2step	SPHWAHDNM251ZU2D2	12852	153	
			MacAdam 3step	SPHWAHDNM251ZU3D2			
		4000	MacAdam 2step	SPHWAHDNM251ZT2D2	13123	156	
	MacAdam 3step	SPHWAHDNM251ZT3D2					
	5000	MacAdam 3step	SPHWAHDNM251ZR3D2	13196	157		
	5700	MacAdam 3step	SPHWAHDNM251ZQ3D2	13258	157		
	6500	MacAdam 3step	SPHWAHDNM251ZP3D2	13121	156		
	90+	2700	MacAdam 2step	SPHWAHDNM271ZW2D2	10157	121	
			MacAdam 3step	SPHWAHDNM271ZW3D2			
		3000	MacAdam 2step	SPHWAHDNM271ZV2D2	10731	127	
			MacAdam 3step	SPHWAHDNM271ZV3D2			
		3500	MacAdam 2step	SPHWAHDNM271ZU2D2	11004	131	
			MacAdam 3step	SPHWAHDNM271ZU3D2			
4000		MacAdam 2step	SPHWAHDNM271ZT2D2	11247	134		
		MacAdam 3step	SPHWAHDNM271ZT3D2				
		5000	MacAdam 3step			SPHWAHDNM271ZR3D2	11375

# D-series Gen 1



T <sub>j</sub> =85°C	LC003D Gen 1	LC006D Gen 1	LC009D Gen 1	LC013D Gen 1	LC016D Gen 1	LC019D Gen 1	LC026D Gen 1	LC040D Gen 1	LC060D Gen 1	LC080D Gen 1
LES	9.8 mm			14.5 mm			22 mm			
Typical	34.6 V								52 V	
	3.1 W (90 mA)	6.2 W (180 mA)	9.4 W (270 mA)	12.5 W (360 mA)	15.6 W (450 mA)	18.7 W (540 mA)	24.9 W (720 mA)	37.4 W (1080 mA)	56.1 W (1080 mA)	84.2 W (1620 mA)
Max.	8.6 W (230 mA)	17.2 W (460 mA)	25.9 W (690 mA)	34.5 W (920 mA)	43.1 W (1150 mA)	51.8 W (1380 mA)	69 W (1840 mA)	103.5 W (2760 mA)	143.4 W (2760 mA)	215 W (2760 mA)
Size	13.5 x 13.5 mm			19 x 19 mm			28 x 28 mm			

## Color Variation

※ CRI: Minimum

Product	CRI90+				CRI80+							CRI70+		
	2700K	3000K	3500K	4000K	2700K	3000K	3500K	4000K	5000K	5700K	6500K	3000K	4000K	5000K
LC003D Gen1	o	o	o	o	o	o	o	o	o	o	o			
LC006D Gen1	o	o	o	o	o	o	o	o	o	o	o			
LC009D Gen1	o	o	o	o	o	o	o	o	o	o	o			
LC013D Gen1	o	o	o	o	o	o	o	o	o	o	o			
LC016D Gen1	o	o	o	o	o	o	o	o	o	o	o			
LC019D Gen1	o	o	o	o	o	o	o	o	o	o	o			
LC026D Gen1	o	o	o	o	o	o	o	o	o	o	o			
LC040D Gen1	o	o	o	o	o	o	o	o	o	o	o			
LC060D Gen1					o	o	o	o	o	o	o	o	o	o
LC080D Gen1					o	o	o	o	o	o	o	o	o	o
MacAdam 2-Step	o	o	o	o	o	o	o	o						
MacAdam 3-Step	o	o	o	o	o	o	o	o	o	o	o	o	o	o

## Specifications

Product	CRI	CCT (K)	Color rank	Part Number	T <sub>j</sub> = 85°C		I <sub>F</sub> (mA) V <sub>F</sub> (V)	
					Luminous Flux Typ. (lm)	Luminous Efficacy Typ. (lm/W)		
80+	2700		MacAdam 2step	SPHWAHDNA25YZW2A9	413	133	90mA 34.6V	
			MacAdam 3step	SPHWAHDNA25YZW3A9				
			MacAdam 2step	SPHWAHDNA25YZW2D1	434	139		
			MacAdam 3step	SPHWAHDNA25YZW3D1				
	3000		MacAdam 2step	SPHWAHDNA25YZV2B1	435	140		
			MacAdam 3step	SPHWAHDNA25YZV3B1				
			MacAdam 2step	SPHWAHDNA25YZV2D1	457	147		
			MacAdam 3step	SPHWAHDNA25YZV3D1				
	3500		MacAdam 2step	SPHWAHDNA25YZU2B2	451	145		
			MacAdam 3step	SPHWAHDNA25YZU3B2				
			MacAdam 2step	SPHWAHDNA25YZU2D1	474	152		
			MacAdam 3step	SPHWAHDNA25YZU3D1				
4000		MacAdam 2step	SPHWAHDNA25YZT2B3	457	147			
		MacAdam 3step	SPHWAHDNA25YZT3B3					
		MacAdam 2step	SPHWAHDNA25YZT2D1	480	154			
		MacAdam 3step	SPHWAHDNA25YZT3D1					
5000	MacAdam 3step		SPHWAHDNA25YZR3B3	462	148			
			SPHWAHDNA25YZR3D1	485	156			
		5700		SPHWAHDNA25YZQ3B3	462	148		
				SPHWAHDNA25YZQ3D1	485	156		
6500	MacAdam 3step		SPHWAHDNA25YZP3B3	457	147			
			SPHWAHDNA25YZP3D1	480	154			
		90+	2700		MacAdam 2step	SPHWAHDNA27YZW2A3	349	112
					MacAdam 3step	SPHWAHDNA27YZW3A3		
MacAdam 2step	SPHWAHDNA27YZW2D1				367	118		
MacAdam 3step	SPHWAHDNA27YZW3D1							
3000			MacAdam 2step	SPHWAHDNA27YZV2A4	365	117		
			MacAdam 3step	SPHWAHDNA27YZV3A4				
			MacAdam 2step	SPHWAHDNA27YZV2D1	384	123		
			MacAdam 3step	SPHWAHDNA27YZV3D1				
3500			MacAdam 2step	SPHWAHDNA27YZU2A5	377	121		
			MacAdam 3step	SPHWAHDNA27YZU3A5				
			MacAdam 2step	SPHWAHDNA27YZU2D1	396	127		
			MacAdam 3step	SPHWAHDNA27YZU3D1				
4000		MacAdam 2step	SPHWAHDNA27YZT2A6	385	124			
		MacAdam 3step	SPHWAHDNA27YZT3A6					
		MacAdam 2step	SPHWAHDNA27YZT2D1	404	130			
		MacAdam 3step	SPHWAHDNA27YZT3D1					
5000	MacAdam 3step		SPHWAHDNA27YZR3A6	387	124			
			SPHWAHDNA27YZR3D1	407	131			



LC003D Gen 1

# Specifications

Product	CRI	CCT (K)	Color rank	Part Number	T <sub>j</sub> = 85°C		I <sub>F</sub> (mA) V <sub>F</sub> (V)
					Luminous Flux Typ. (lm)	Luminous Efficacy Typ. (lm/W)	
 LC006D Gen1	80+	2700	MacAdam 2step	SPHWAHDNB25YZW2E9	832	134	180mA 34.6V
			MacAdam 3step	SPHWAHDNB25YZW3E9			
			MacAdam 2step	SPHWAHDNB25YZW2D1	874	140	
			MacAdam 3step	SPHWAHDNB25YZW3D1			
		3000	MacAdam 2step	SPHWAHDNB25YZV2F3	875	140	
			MacAdam 3step	SPHWAHDNB25YZV3F3			
			MacAdam 2step	SPHWAHDNB25YZV2D1	919	148	
			MacAdam 3step	SPHWAHDNB25YZV3D1			
		3500	MacAdam 2step	SPHWAHDNB25YZU2F5	902	145	
			MacAdam 3step	SPHWAHDNB25YZU3F5			
			MacAdam 2step	SPHWAHDNB25YZU2D1	947	152	
			MacAdam 3step	SPHWAHDNB25YZU3D1			
		4000	MacAdam 2step	SPHWAHDNB25YZT2F8	923	148	
			MacAdam 3step	SPHWAHDNB25YZT3F8			
			MacAdam 2step	SPHWAHDNB25YZT2D1	969	156	
			MacAdam 3step	SPHWAHDNB25YZT3D1			
	5000	MacAdam 3step	SPHWAHDNB25YZR3F8	928	149		
			SPHWAHDNB25YZR3D1	975	157		
	5700	MacAdam 3step	SPHWAHDNB25YZQ3F8	928	149		
			SPHWAHDNB25YZQ3D1	975	157		
	6500	MacAdam 3step	SPHWAHDNB25YZP3F7	918	147		
			SPHWAHDNB25YZP3D1	964	155		
	90+	2700	MacAdam 2step	SPHWAHDNB27YZW2D7	709	114	
			MacAdam 3step	SPHWAHDNB27YZW3D7			
			MacAdam 2step	SPHWAHDNB27YZW2D1	744	119	
			MacAdam 3step	SPHWAHDNB27YZW3D1			
		3000	MacAdam 2step	SPHWAHDNB27YZV2E9	743	119	
			MacAdam 3step	SPHWAHDNB27YZV3E9			
MacAdam 2step			SPHWAHDNB27YZV2D1	780	125		
MacAdam 3step			SPHWAHDNB27YZV3D1				
3500		MacAdam 2step	SPHWAHDNB27YZU2E0	768	123		
		MacAdam 3step	SPHWAHDNB27YZU3E0				
		MacAdam 2step	SPHWAHDNB27YZU2D1	807	130		
		MacAdam 3step	SPHWAHDNB27YZU3D1				
4000	MacAdam 2step	SPHWAHDNB27YZT2E4	784	126			
	MacAdam 3step	SPHWAHDNB27YZT3E4					
	MacAdam 2step	SPHWAHDNB27YZT2D1	824	132			
	MacAdam 3step	SPHWAHDNB27YZT3D1					
5000	MacAdam 3step	SPHWAHDNB27YZR3E4	787	126			
		SPHWAHDNB27YZR3D1	827	133			

Product	CRI	CCT (K)	Color rank	Part Number	T <sub>j</sub> = 85°C		I <sub>F</sub> (mA) V <sub>F</sub> (V)
					Luminous Flux Typ. (lm)	Luminous Efficacy Typ. (lm/W)	
 LC009D Gen1	80+	2700	MacAdam 2step	SPHWAHDNC25YZW2H1	1209	129	270mA 34.6V
			MacAdam 3step	SPHWAHDNC25YZW3H1			
			MacAdam 2step	SPHWAHDNC25YZW2D1	1270	136	
			MacAdam 3step	SPHWAHDNC25YZW3D1			
		3000	MacAdam 2step	SPHWAHDNC25YZV2H2	1278	137	
			MacAdam 3step	SPHWAHDNC25YZV3H2			
			MacAdam 2step	SPHWAHDNC25YZV2D1	1342	144	
			MacAdam 3step	SPHWAHDNC25YZV3D1			
		3500	MacAdam 2step	SPHWAHDNC25YZU2H2	1315	141	
			MacAdam 3step	SPHWAHDNC25YZU3H2			
			MacAdam 2step	SPHWAHDNC25YZU2D1	1381	148	
			MacAdam 3step	SPHWAHDNC25YZU3D1			
		4000	MacAdam 2step	SPHWAHDNC25YZT2H2	1347	144	
			MacAdam 3step	SPHWAHDNC25YZT3H2			
			MacAdam 2step	SPHWAHDNC25YZT2D1	1414	151	
			MacAdam 3step	SPHWAHDNC25YZT3D1			
	5000	MacAdam 3step	SPHWAHDNC25YZR3H2	1357	145		
			SPHWAHDNC25YZR3D1	1425	153		
	5700	MacAdam 3step	SPHWAHDNC25YZQ3H2	1357	145		
			SPHWAHDNC25YZQ3D1	1425	153		
	6500	MacAdam 3step	SPHWAHDNC25YZP3H2	1341	144		
			SPHWAHDNC25YZP3D1	1408	151		
	90+	2700	MacAdam 2step	SPHWAHDNC27YZW2G8	1038	111	
			MacAdam 3step	SPHWAHDNC27YZW3G8			
			MacAdam 2step	SPHWAHDNC27YZW2D1	1090	117	
			MacAdam 3step	SPHWAHDNC27YZW3D1			
		3000	MacAdam 2step	SPHWAHDNC27YZV2H0	1087	116	
			MacAdam 3step	SPHWAHDNC27YZV3H0			
MacAdam 2step			SPHWAHDNC27YZV2D1	1141	122		
MacAdam 3step			SPHWAHDNC27YZV3D1				
3500		MacAdam 2step	SPHWAHDNC27YZU2H0	1122	120		
		MacAdam 3step	SPHWAHDNC27YZU3H0				
		MacAdam 2step	SPHWAHDNC27YZU2D1	1178	126		
		MacAdam 3step	SPHWAHDNC27YZU3D1				
4000	MacAdam 2step	SPHWAHDNC27YZT2H0	1147	123			
	MacAdam 3step	SPHWAHDNC27YZT3H0					
	MacAdam 2step	SPHWAHDNC27YZT2D1	1204	129			
	MacAdam 3step	SPHWAHDNC27YZT3D1					
5000	MacAdam 3step	SPHWAHDNC27YZR3H1	1152	123			
		SPHWAHDNC27YZR3D1	1210	130			

# Specifications

Product	CRI	CCT (K)	Color rank	Part Number	T <sub>j</sub> = 85°C		I <sub>F</sub> (mA) V <sub>F</sub> (V)
					Luminous Flux Typ. (lm)	Luminous Efficacy Typ. (lm/W)	
 LC013D Gen 1	80+	2700	MacAdam 2step	SPHWAHDND25YZW2H5	1589	128	360mA 34.6V
			MacAdam 3step	SPHWAHDND25YZW3H5			
			MacAdam 2step	SPHWAHDND25YZW2D1	1669	134	
			MacAdam 3step	SPHWAHDND25YZW3D1			
		3000	MacAdam 2step	SPHWAHDND25YZV2H5	1673	134	
			MacAdam 3step	SPHWAHDND25YZV3H5			
			MacAdam 2step	SPHWAHDND25YZV2D1	1757	141	
			MacAdam 3step	SPHWAHDND25YZV3D1			
		3500	MacAdam 2step	SPHWAHDND25YZU2H6	1725	138	
			MacAdam 3step	SPHWAHDND25YZU3H6			
			MacAdam 2step	SPHWAHDND25YZU2D1	1812	145	
			MacAdam 3step	SPHWAHDND25YZU3D1			
		4000	MacAdam 2step	SPHWAHDND25YZT2H6	1757	141	
			MacAdam 3step	SPHWAHDND25YZT3H6			
			MacAdam 2step	SPHWAHDND25YZT2D1	1844	148	
			MacAdam 3step	SPHWAHDND25YZT3D1			
	5000	MacAdam 3step	SPHWAHDND25YZR3H6	1772	142		
			SPHWAHDND25YZR3D1	1861	149		
	5700	MacAdam 3step	SPHWAHDND25YZQ3H6	1772	142		
			SPHWAHDND25YZQ3D1	1861	149		
	6500	MacAdam 3step	SPHWAHDND25YZP3H6	1746	140		
			SPHWAHDND25YZP3D1	1834	147		
	90+	2700	MacAdam 2step	SPHWAHDND27YZW2H2	1359	109	
			MacAdam 3step	SPHWAHDND27YZW3H2			
			MacAdam 2step	SPHWAHDND27YZW2D1	1427	115	
			MacAdam 3step	SPHWAHDND27YZW3D2			
		3000	MacAdam 2step	SPHWAHDND27YZV2H3	1423	114	
			MacAdam 3step	SPHWAHDND27YZV3H3			
MacAdam 2step			SPHWAHDND27YZV2D1	1494	120		
MacAdam 3step			SPHWAHDND27YZV3D1				
3500		MacAdam 2step	SPHWAHDND27YZU2H4	1473	118		
		MacAdam 3step	SPHWAHDND27YZU3H4				
		MacAdam 2step	SPHWAHDND27YZU2D1	1547	124		
		MacAdam 3step	SPHWAHDND27YZU3D1				
4000	MacAdam 2step	SPHWAHDND27YZT2H4	1505	121			
	MacAdam 3step	SPHWAHDND27YZT3H4					
	MacAdam 2step	SPHWAHDND27YZT2D1	1580	127			
	MacAdam 3step	SPHWAHDND27YZT3D1					
5000	MacAdam 3step	SPHWAHDND27YZR3H4	1508	121			
		SPHWAHDND27YZR3D1	1584	127			

Product	CRI	CCT (K)	Color rank	Part Number	T <sub>j</sub> = 85°C		I <sub>F</sub> (mA) V <sub>F</sub> (V)
					Luminous Flux Typ. (lm)	Luminous Efficacy Typ. (lm/W)	
 LC016D Gen 1	80+	2700	MacAdam 2step	SPHWAHDNE25YZW2H9	2065	133	450mA 34.6V
			MacAdam 3step	SPHWAHDNE25YZW3H9			
			MacAdam 2step	SPHWAHDNE25YZW2D1	2169	139	
			MacAdam 3step	SPHWAHDNE25YZW3D1			
		3000	MacAdam 2step	SPHWAHDNE25YZV2J0	2182	140	
			MacAdam 3step	SPHWAHDNE25YZV3J0			
			MacAdam 2step	SPHWAHDNE25YZV2D1	2291	147	
			MacAdam 3step	SPHWAHDNE25YZV3D1			
		3500	MacAdam 2step	SPHWAHDNE25YZU2J1	2263	145	
			MacAdam 3step	SPHWAHDNE25YZU3J1			
			MacAdam 2step	SPHWAHDNE25YZU2D1	2376	153	
			MacAdam 3step	SPHWAHDNE25YZU3D1			
		4000	MacAdam 2step	SPHWAHDNE25YZT2J1	2304	148	
			MacAdam 3step	SPHWAHDNE25YZT3J1			
			MacAdam 2step	SPHWAHDNE25YZT2D1	2419	155	
			MacAdam 3step	SPHWAHDNE25YZT3D1			
	5000	MacAdam 3step	SPHWAHDNE25YZR3J2	2324	149		
			SPHWAHDNE25YZR3D1	2440	157		
	5700	MacAdam 3step	SPHWAHDNE25YZQ3J2	2324	149		
			SPHWAHDNE25YZQ3D1	2440	157		
	6500	MacAdam 3step	SPHWAHDNE25YZP3J1	2304	148		
			SPHWAHDNE25YZP3D1	2419	155		
	90+	2700	MacAdam 2step	SPHWAHDNE27YZW2H6	1771	114	
			MacAdam 3step	SPHWAHDNE27YZW3H6			
			MacAdam 2step	SPHWAHDNE27YZW2D1	1860	119	
			MacAdam 3step	SPHWAHDNE27YZW3D1			
		3000	MacAdam 2step	SPHWAHDNE27YZV2H7	1877	121	
			MacAdam 3step	SPHWAHDNE27YZV3H7			
MacAdam 2step			SPHWAHDNE27YZV2D1	1970	127		
MacAdam 3step			SPHWAHDNE27YZV3D1				
3500		MacAdam 2step	SPHWAHDNE27YZU2H8	1932	124		
		MacAdam 3step	SPHWAHDNE27YZU3H8				
		MacAdam 2step	SPHWAHDNE27YZU2D1	2029	130		
		MacAdam 3step	SPHWAHDNE27YZU3D1				
4000	MacAdam 2step	SPHWAHDNE27YZT2H8	1971	127			
	MacAdam 3step	SPHWAHDNE27YZT3H8					
	MacAdam 2step	SPHWAHDNE27YZT2D1	2069	133			
	MacAdam 3step	SPHWAHDNE27YZT3D1					
5000	MacAdam 3step	SPHWAHDNE27YZR3H8	1989	128			
		SPHWAHDNE27YZR3D1	2089	134			



# Specifications

Product	CRI	CCT (K)	Color rank	Part Number	T <sub>j</sub> = 85°C		I <sub>F</sub> (mA) V <sub>F</sub> (V)	
					Luminous Flux Typ. (lm)	Luminous Efficacy Typ. (lm/W)		
 LC019D Gen 1	80+	2700	MacAdam 2step	SPHWAHDNF25YZW2J3	2458	132	540mA 34.6V	
			MacAdam 3step	SPHWAHDNF25YZW3J3				
			MacAdam 2step	SPHWAHDNF25YZW2D1	2581	138		
			MacAdam 3step	SPHWAHDNF25YZW3D1				
		3000	MacAdam 2step	SPHWAHDNF25YZV24	2592	139		
			MacAdam 3step	SPHWAHDNF25YZV3J4				
			MacAdam 2step	SPHWAHDNF25YZV2D1	2722	146		
			MacAdam 3step	SPHWAHDNF25YZV3D1				
		3500	MacAdam 2step	SPHWAHDNF25YZU25	2672	143		
			MacAdam 3step	SPHWAHDNF25YZU3J5				
			MacAdam 2step	SPHWAHDNF25YZU2D1	2805	150		
			MacAdam 3step	SPHWAHDNF25YZU3D1				
		4000	MacAdam 2step	SPHWAHDNF25YZT25	2726	146		
			MacAdam 3step	SPHWAHDNF25YZT3J5				
			MacAdam 2step	SPHWAHDNF25YZT2D1	2863	153		
			MacAdam 3step	SPHWAHDNF25YZT3D1				
		5000	MacAdam 3step	SPHWAHDNF25YZR3J6	2756	148		
				SPHWAHDNF25YZR3D1	2894	155		
		5700	MacAdam 3step	SPHWAHDNF25YZQ3J6	2756	148		
				SPHWAHDNF25YZQ3D1	2894	155		
		6500	MacAdam 3step	SPHWAHDNF25YZP3J5	2726	146		
				SPHWAHDNF25YZP3D1	2863	153		
		90+	2700	MacAdam 2step	SPHWAHDNF27YZW2H9	2104		113
				MacAdam 3step	SPHWAHDNF27YZW3H9			
				MacAdam 2step	SPHWAHDNF27YZW2D1	2210		118
				MacAdam 3step	SPHWAHDNF27YZW3D1			
			3000	MacAdam 2step	SPHWAHDNF27YZV2J0	2207		118
				MacAdam 3step	SPHWAHDNF27YZV3J0			
MacAdam 2step	SPHWAHDNF27YZV2D1			2317	124			
MacAdam 3step	SPHWAHDNF27YZV3D1							
3500	MacAdam 2step		SPHWAHDNF27YZU2J1	2287	122			
	MacAdam 3step		SPHWAHDNF27YZU3J1					
	MacAdam 2step		SPHWAHDNF27YZU2D1	2402	129			
	MacAdam 3step		SPHWAHDNF27YZU3D1					
4000	MacAdam 2step		SPHWAHDNF27YZT2J2	2337	125			
	MacAdam 3step		SPHWAHDNF27YZT3J2					
	MacAdam 2step		SPHWAHDNF27YZT2D1	2454	131			
	MacAdam 3step		SPHWAHDNF27YZT3D1					
5000	MacAdam 3step		SPHWAHDNG27YZR3J8	2339	125			
			SPHWAHDNG27YZR3D1	2456	131			

Product	CRI	CCT (K)	Color rank	Part Number	T <sub>j</sub> = 85°C		I <sub>F</sub> (mA) V <sub>F</sub> (V)	
					Luminous Flux Typ. (lm)	Luminous Efficacy Typ. (lm/W)		
 LC026D Gen 1	80+	2700	MacAdam 2step	SPHWAHDNK25YZW2M7	3225	129	720mA 34.6V	
			MacAdam 3step	SPHWAHDNK25YZW3M7				
			MacAdam 2step	SPHWAHDNK25YZW2D1	3386	136		
			MacAdam 3step	SPHWAHDNK25YZW3D1				
		3000	MacAdam 2step	SPHWAHDNK25YZV2M9	3389	136		
			MacAdam 3step	SPHWAHDNK25YZV3M9				
			MacAdam 2step	SPHWAHDNK25YZV2D1	3558	143		
			MacAdam 3step	SPHWAHDNK25YZV3D1				
		3500	MacAdam 2step	SPHWAHDNK25YZU2N1	3488	140		
			MacAdam 3step	SPHWAHDNK25YZU3N1				
			MacAdam 2step	SPHWAHDNK25YZU2D1	3663	147		
			MacAdam 3step	SPHWAHDNK25YZU3D1				
		4000	MacAdam 2step	SPHWAHDNK25YZT2N2	3558	143		
			MacAdam 3step	SPHWAHDNK25YZT3N2				
			MacAdam 2step	SPHWAHDNK25YZT2D1	3736	150		
			MacAdam 3step	SPHWAHDNK25YZT3D1				
		5000	MacAdam 3step	SPHWAHDNK25YZR3N2	3588	144		
				SPHWAHDNK25YZR3D1	3767	151		
		5700	MacAdam 3step	SPHWAHDNK25YZQ3N3	3588	144		
				SPHWAHDNK25YZQ3D1	3767	151		
		6500	MacAdam 3step	SPHWAHDNK25YZP3N2	3558	143		
				SPHWAHDNK25YZP3D1	3736	150		
		90+	2700	MacAdam 2step	SPHWAHDNK27YZW2M0	2760		111
				MacAdam 3step	SPHWAHDNK27YZW3M0			
				MacAdam 2step	SPHWAHDNK27YZW2D1	2898		116
				MacAdam 3step	SPHWAHDNK27YZW3D1			
			3000	MacAdam 2step	SPHWAHDNK27YZV2M2	2903		117
				MacAdam 3step	SPHWAHDNK27YZV3M2			
MacAdam 2step	SPHWAHDNK27YZV2D1			3048	122			
MacAdam 3step	SPHWAHDNK27YZV3D1							
3500	MacAdam 2step		SPHWAHDNK27YZU2M4	2990	120			
	MacAdam 3step		SPHWAHDNK27YZU3M4					
	MacAdam 2step		SPHWAHDNK27YZU2D1	3139	126			
	MacAdam 3step		SPHWAHDNK27YZU3D1					
4000	MacAdam 2step		SPHWAHDNK27YZT2M5	3051	122			
	MacAdam 3step		SPHWAHDNK27YZT3M5					
	MacAdam 2step		SPHWAHDNK27YZT2D1	3204	129			
	MacAdam 3step		SPHWAHDNK27YZT3D1					
5000	MacAdam 3step		SPHWAHDNK27YZR3M5	3077	124			
			SPHWAHDNK27YZR3D1	3231	130			

# Specifications

Product	CRI	CCT (K)	Color rank	Part Number	T <sub>j</sub> = 85°C		I <sub>F</sub> (mA) V <sub>F</sub> (V)
					Luminous Flux Typ. (lm)	Luminous Efficacy Typ. (lm/W)	
 LC040D Gen1	80+	2700	MacAdam 2step	SPHWAHDNG25YZW2K0	4996	134	1080mA 34.6V
			MacAdam 3step	SPHWAHDNG25YZW3K0			
			MacAdam 2step	SPHWAHDNG25YZW2D1	5246	140	
			MacAdam 3step	SPHWAHDNG25YZW3D1			
		3000	MacAdam 2step	SPHWAHDNG25YZV2K2	5257	141	
			MacAdam 3step	SPHWAHDNG25YZV3K2			
			MacAdam 2step	SPHWAHDNG25YZV2D1	5520	148	
			MacAdam 3step	SPHWAHDNG25YZV3D1			
		3500	MacAdam 2step	SPHWAHDNG25YZU2K3	5418	145	
			MacAdam 3step	SPHWAHDNG25YZU3K3			
			MacAdam 2step	SPHWAHDNG25YZU2D1	5689	152	
			MacAdam 3step	SPHWAHDNG25YZU3D1			
	4000	MacAdam 2step	SPHWAHDNG25YZT2K3	5535	148		
		MacAdam 3step	SPHWAHDNG25YZT3K3				
		MacAdam 2step	SPHWAHDNG25YZT2D1	5812	156		
		MacAdam 3step	SPHWAHDNG25YZT3D1				
	5000	MacAdam 3step	SPHWAHDNG25YZR3K4	5561	149		
			SPHWAHDNG25YZR3D1	5839	156		
		MacAdam 3step	SPHWAHDNG25YZQ3K4	5588	150		
			SPHWAHDNG25YZQ3D1	5868	157		
	6500	MacAdam 3step	SPHWAHDNG25YZP3K3	5528	148		
			SPHWAHDNG25YZP3D1	5804	155		
		2700	MacAdam 2step	SPHWAHDNG27YZW2J6	4283	115	
			MacAdam 3step	SPHWAHDNG27YZW3J6			
	MacAdam 2step		SPHWAHDNG27YZW2D1	4497	120		
	MacAdam 3step		SPHWAHDNG27YZW3D1				
	3000	MacAdam 2step	SPHWAHDNG27YZV2J7	4525	121		
		MacAdam 3step	SPHWAHDNG27YZV3J7				
		MacAdam 2step	SPHWAHDNG27YZV2D1	4751	127		
		MacAdam 3step	SPHWAHDNG27YZV3D1				
3500	MacAdam 2step	SPHWAHDNG27YZU2J8	4640	124			
	MacAdam 3step	SPHWAHDNG27YZU3J8					
	MacAdam 2step	SPHWAHDNG27YZU2D1	4872	130			
	MacAdam 3step	SPHWAHDNG27YZU3D1					
4000	MacAdam 2step	SPHWAHDNG27YZT2J8	4742	127			
	MacAdam 3step	SPHWAHDNG27YZT3J8					
	MacAdam 2step	SPHWAHDNG27YZT2D1	4979	133			
	MacAdam 3step	SPHWAHDNG27YZT3D1					
5000	MacAdam 3step	SPHWAHDNG27YZR3J8	4796	128			
		SPHWAHDNG27YZR3D1	5036	135			

Product	CRI	CCT (K)	Color rank	Part Number	T <sub>j</sub> = 85°C		I <sub>F</sub> (mA) V <sub>F</sub> (V)
					Luminous Flux Typ. (lm)	Luminous Efficacy Typ. (lm/W)	
 LC060D Gen1	70+	3000	MacAdam 3step	SPHWAHDNL231ZV3Q8	8284	148	1080mA 52V
		4000	MacAdam 3step	SPHWAHDNL231ZT3R1	8550	152	
		5000	MacAdam 3step	SPHWAHDNL231ZR3R2	8683	155	
		2700	MacAdam 2step	SPHWAHDNL251ZW2P9	7277	130	
			MacAdam 3step	SPHWAHDNL251ZW3P9			
		3000	MacAdam 2step	SPHWAHDNL251ZV2Q3	7667	137	
	MacAdam 3step		SPHWAHDNL251ZV3Q3				
	80+	3500	MacAdam 2step	SPHWAHDNL251ZU2Q5	7904	141	
			MacAdam 3step	SPHWAHDNL251ZU3Q5			
		4000	MacAdam 2step	SPHWAHDNL251ZT2Q6	8075	144	
			MacAdam 3step	SPHWAHDNL251ZT3Q6			
		5000	MacAdam 3step	SPHWAHDNL251ZR3Q7	8113	144	
5700		MacAdam 3step	SPHWAHDNL251ZQ3Q7	8151	145		
6500	MacAdam 3step	SPHWAHDNL271ZP3Q6	8066	144			
 LC080D Gen1	70+	3000	MacAdam 3step	SPHWAHDNM231ZV3U5	12084	143	1620mA 52V
		4000	MacAdam 3step	SPHWAHDNM231ZT3U9	12483	148	
		5000	MacAdam 3step	SPHWAHDNM231ZR3V0	12673	150	
		2700	MacAdam 2step	SPHWAHDNM251ZW2T1	10612	126	
			MacAdam 3step	SPHWAHDNM251ZW3T1			
		3000	MacAdam 2step	SPHWAHDNM251ZV2T6	11201	133	
	MacAdam 3step		SPHWAHDNM251ZV3T6				
	80+	3500	MacAdam 2step	SPHWAHDNM251ZU2T9	11533	137	
			MacAdam 3step	SPHWAHDNM251ZU3T9			
		4000	MacAdam 2step	SPHWAHDNM251ZT2U2	11780	140	
			MacAdam 3step	SPHWAHDNM251ZT3U2			
		5000	MacAdam 3step	SPHWAHDNM251ZR3U2	11847	141	
5700		MacAdam 3step	SPHWAHDNM251ZQ3V0	11904	141		
6500	MacAdam 3step	SPHWAHDNM251ZP3V5	11723	139			

# D-series Premium color - High CRI

- Full line-up for major applications: ultra high CRI for spot & down lights
- Excellent color index distribution

T <sub>j</sub> =85°C	LC013D	LC016D	LC019D	LC026D	LC033D	LC040D
LES	9.8mm	14.5mm				22 mm
Typical	34.6 V					
	12.5W (360mA)	15.6W (450mA)	18.7W (540mA)	24.9W (720mA)	31.1W (900mA)	37.4W (1080mA)
Max.	34.5W (920mA)	43.1W (1150mA)	51.8W (1380mA)	69.0W (1840mA)	86.2W (2300mA)	103.5W (2760mA)
Size	13.5mm x 13.5mm	19mm x 19mm				28mm x 28mm

## Ultra High CRI (Ra 95+): Typ. R9 ≅ 90

(2700K~4000K)

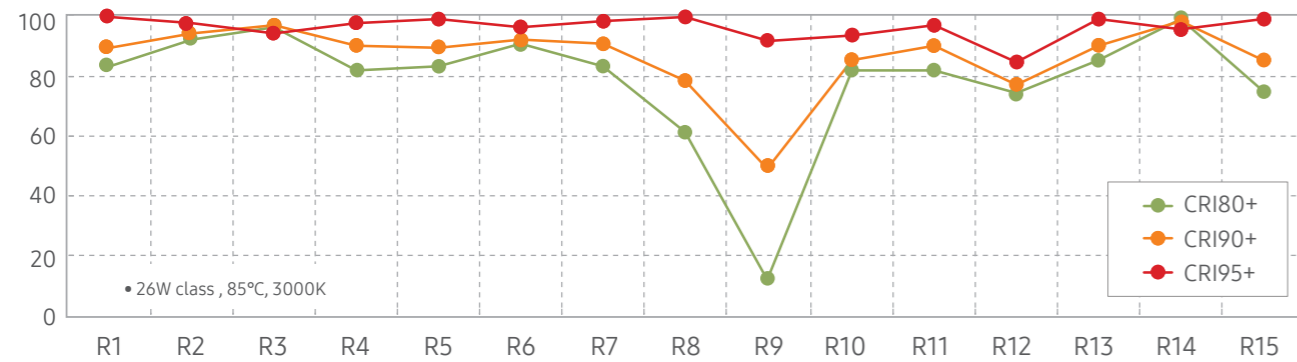

## Color Variation

Product	High CRI 95+				
	2700K	3000K	3500K	4000K	5000K
LC013D	o	o	o	o	o
LC016D	o	o	o	o	o
LC019D	o	o	o	o	o
LC026D	o	o	o	o	o
LC033D	o	o	o	o	o
LC040D	o	o	o	o	o
MacAdam 2-Step	o	o	o	o	o
MacAdam 3-Step	o	o	o	o	o

## Specifications

Product	CRI	CCT (K)	Color rank	Part Number	T <sub>j</sub> = 85°C		I <sub>F</sub> (mA) V <sub>F</sub> (V)
					Luminous Flux Typ. (lm)	Luminous Efficacy Typ. (lm/W)	
LC013D Premium color	95+	2700	MacAdam 2step	SPHWHAHNDND28YZW2D2	1223	98	360mA 34.6V
			MacAdam 3step	SPHWHAHNDND28YZW3D2			
		3000	MacAdam 2step	SPHWHAHNDND28YZV2D2	1285	103	
			MacAdam 3step	SPHWHAHNDND28YZV3D2			
		3500	MacAdam 2step	SPHWHAHNDND28YZU2D2	1337	107	
			MacAdam 3step	SPHWHAHNDND28YZU3D2			
4000	MacAdam 2step	SPHWHAHNDND28YZT2D2	1379	111			
	MacAdam 3step	SPHWHAHNDND28YZT3D2					
LC016D Premium color	95+	2700	MacAdam 2step	SPHWHAHDNE28YZW2D2	1575	101	450mA 34.6V
			MacAdam 3step	SPHWHAHDNE28YZW3D2			
		3000	MacAdam 2step	SPHWHAHDNE28YZV2D2	1655	106	
			MacAdam 3step	SPHWHAHDNE28YZV3D2			
		3500	MacAdam 2step	SPHWHAHDNE28YZU2D2	1722	111	
			MacAdam 3step	SPHWHAHDNE28YZU3D2			
4000	MacAdam 2step	SPHWHAHDNE28YZT2D2	1776	114			
	MacAdam 3step	SPHWHAHDNE28YZT3D2					
5000	MacAdam 3step	SPHWHAHDNE28YZR3D2	1791	115			
	LC019D Premium color	95+	2700	MacAdam 2step	SPHWHAHDNF28YZW2D2	1880	101
MacAdam 3step				SPHWHAHDNF28YZW3D2			
3000			MacAdam 2step	SPHWHAHDNF28YZV2D2	1976	106	
			MacAdam 3step	SPHWHAHDNF28YZV3D2			
3500			MacAdam 2step	SPHWHAHDNF28YZU2D2	2056	110	
			MacAdam 3step	SPHWHAHDNF28YZU3D2			
4000	MacAdam 2step	SPHWHAHDNF28YZT2D2	2121	114			
	MacAdam 3step	SPHWHAHDNF28YZT3D2					
5000	MacAdam 3step	SPHWHAHDNF28YZR3D2	2138	114			
	LC026D Premium color	95+	2700	MacAdam 2step	SPHWHAHDNG28YZW2D2	2470	99
MacAdam 3step				SPHWHAHDNG28YZW3D2			
3000			MacAdam 2step	SPHWHAHDNG28YZV2D2	2596	104	
			MacAdam 3step	SPHWHAHDNG28YZV3D2			
3500			MacAdam 2step	SPHWHAHDNG28YZU2D2	2701	108	
			MacAdam 3step	SPHWHAHDNG28YZU3D2			
4000	MacAdam 2step	SPHWHAHDNG28YZT2D2	2786	112			
	MacAdam 3step	SPHWHAHDNG28YZT3D2					
5000	MacAdam 3step	SPHWHAHDNG28YZR3D2	2809	113			
	LC033D Premium color	95+	2700	MacAdam 2step	SPHWHAHDNH28YZW2D2	3057	98
MacAdam 3step				SPHWHAHDNH28YZW3D2			
3000			MacAdam 2step	SPHWHAHDNH28YZV2D2	3212	103	
			MacAdam 3step	SPHWHAHDNH28YZV3D2			
3500			MacAdam 2step	SPHWHAHDNH28YZU2D2	3343	107	
			MacAdam 3step	SPHWHAHDNH28YZU3D2			
4000	MacAdam 2step	SPHWHAHDNH28YZT2D2	3447	111			
	MacAdam 3step	SPHWHAHDNH28YZT3D2					
5000	MacAdam 3step	SPHWHAHDNH28YZR3D2	3476	112			
	LC040D Premium color	95+	2700	MacAdam 2step	SPHWHAHDNK28YZW2D2	3760	101
MacAdam 3step				SPHWHAHDNK28YZW3D2			
3000			MacAdam 2step	SPHWHAHDNK28YZV2D2	3952	106	
			MacAdam 3step	SPHWHAHDNK28YZV3D2			
3500			MacAdam 2step	SPHWHAHDNK28YZU2D2	4113	110	
			MacAdam 3step	SPHWHAHDNK28YZU3D2			
4000	MacAdam 2step	SPHWHAHDNK28YZT2D2	4241	113			
	MacAdam 3step	SPHWHAHDNK28YZT3D2					
5000	MacAdam 3step	SPHWHAHDNK28YZR3D2	4277	114			



# D-series Premium color - Vivid color

- Vivid white without yellowish tint
- Attractive color for human eye perception
- The chromaticity of vivid color COB - Below B.B.L

T <sub>J</sub> =85°C	LC013D	LC016D	LC019D	LC026D	LC033D	LC040D
LES	9.8mm	14.5mm				22 mm
Typical	34.6 V					
	12.5W (360mA)	15.6W (450mA)	18.7W (540mA)	24.9W (720mA)	31.1W (900mA)	37.4W (1080mA)
Max.	34.5W (920mA)	43.1W (1150mA)	51.8W (1380mA)	69.0W (1840mA)	86.2W (2300mA)	103.5W (2760mA)
Size	13.5mm x 13.5mm	19mm x 19mm				28mm x 28mm

## Vivid spectrum enables high contrast for showcases



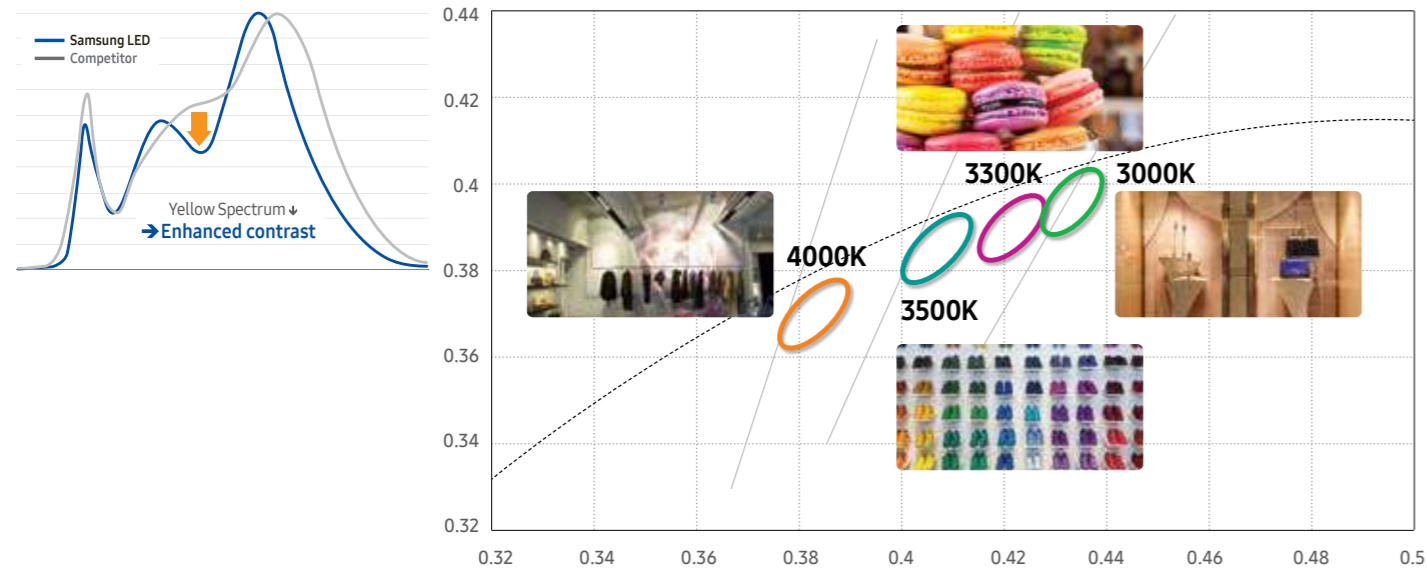



Below BBL : 3000K, 3300K, 3500K, 4000K



## Color Variation

Product	Vivid (Below B.B.L.)			
	3000K	3300K	3500K	4000K
LC013D	○	○	○	○
LC016D	○	○	○	○
LC019D	○	○	○	○
LC026D	○	○	○	○
LC033D	○	○	○	○
MacAdam 2-Step	○	○	○	○
MacAdam 3-Step	○	○	○	○

## Specifications

Product	CRI	CCT (K)	Color rank	Part Number	T <sub>J</sub> = 85°C		I <sub>F</sub> (mA) V <sub>F</sub> (V)
					Luminous Flux Typ. (lm)	Luminous Efficacy Typ. (lm/W)	
 LC013D Premium color	Vivid color	3000 (Below BBL)	MacAdam 2step	SPHWAHDND2VYZV2D2	1334	107	360mA 34.6V
			MacAdam 3step	SPHWAHDND2VYZVVD2			
		3300 (Below BBL)	MacAdam 2step	SPHWAHDND2VYZA2D2	1394	112	
			MacAdam 3step	SPHWAHDND2VYZAVD2			
		3500 (Below BBL)	MacAdam 2step	SPHWAHDND2VYZU2D2	1433	115	
			MacAdam 3step	SPHWAHDND2VYZUVD2			
		4000 (Below BBL)	MacAdam 2step	SPHWAHDND2VYZT2D2	1533	123	
			MacAdam 3step	SPHWAHDND2VYZTVD2			
 LC016D Premium color	Vivid color	3000 (Below BBL)	MacAdam 2step	SPHWAHDNE2VYZV2D2	1745	112	450mA 34.6V
			MacAdam 3step	SPHWAHDNE2VYZVVD2			
		3300 (Below BBL)	MacAdam 2step	SPHWAHDNE2VYZA2D2	1823	117	
			MacAdam 3step	SPHWAHDNE2VYZAVD2			
		3500 (Below BBL)	MacAdam 2step	SPHWAHDNE2VYZU2D2	1875	120	
			MacAdam 3step	SPHWAHDNE2VYZUVD2			
		4000 (Below BBL)	MacAdam 2step	SPHWAHDNE2VYZT2D2	2005	129	
			MacAdam 3step	SPHWAHDNE2VYZTVD2			
 LC019D Premium color	Vivid color	3000 (Below BBL)	MacAdam 2step	SPHWAHDNF2VYZV2D2	2068	111	540mA 34.6V
			MacAdam 3step	SPHWAHDNF2VYZVVD2			
		3300 (Below BBL)	MacAdam 2step	SPHWAHDNF2VYZA2D2	2160	116	
			MacAdam 3step	SPHWAHDNF2VYZAVD2			
		3500 (Below BBL)	MacAdam 2step	SPHWAHDNF2VYZU2D2	2222	119	
			MacAdam 3step	SPHWAHDNF2VYZUVD2			
		4000 (Below BBL)	MacAdam 2step	SPHWAHDNF2VYZT2D2	2376	127	
			MacAdam 3step	SPHWAHDNF2VYZTVD2			
 LC026D Premium color	Vivid color	3000 (Below BBL)	MacAdam 2step	SPHWAHDNG2VYZV2D2	2706	109	720mA 34.6V
			MacAdam 3step	SPHWAHDNG2VYZVVD2			
		3300 (Below BBL)	MacAdam 2step	SPHWAHDNG2VYZA2D2	2827	113	
			MacAdam 3step	SPHWAHDNG2VYZAVD2			
		3500 (Below BBL)	MacAdam 2step	SPHWAHDNG2VYZU2D2	2907	117	
			MacAdam 3step	SPHWAHDNG2VYZUVD2			
		4000 (Below BBL)	MacAdam 2step	SPHWAHDNG2VYZT2D2	3108	125	
			MacAdam 3step	SPHWAHDNG2VYZTVD2			
 LC033D Premium color	Vivid color	3000 (Below BBL)	MacAdam 2step	SPHWAHDNH2VYZV2D2	3339	107	900mA 34.6V
			MacAdam 3step	SPHWAHDNH2VYZVVD2			
		3300 (Below BBL)	MacAdam 2step	SPHWAHDNH2VYZA2D2	3488	112	
			MacAdam 3step	SPHWAHDNH2VYZAVD2			
		3500 (Below BBL)	MacAdam 2step	SPHWAHDNH2VYZU2D2	3588	115	
			MacAdam 3step	SPHWAHDNH2VYZUVD2			
		4000 (Below BBL)	MacAdam 2step	SPHWAHDNH2VYZT2D2	3836	123	
			MacAdam 3step	SPHWAHDNH2VYZTVD2			
 LC040D Premium color	Vivid color	3000 (Below BBL)	MacAdam 2step	SPHWAHDNK2VYZV2D2	4150	111	1080mA 34.6V
			MacAdam 3step	SPHWAHDNK2VYZVVD2			
		3300 (Below BBL)	MacAdam 2step	SPHWAHDNK2VYZA2D2	4335	116	
			MacAdam 3step	SPHWAHDNK2VYZAVD2			
		3500 (Below BBL)	MacAdam 2step	SPHWAHDNK2VYZU2D2	4459	119	
			MacAdam 3step	SPHWAHDNK2VYZUVD2			
		4000 (Below BBL)	MacAdam 2step	SPHWAHDNK2VYZT2D2	4768	128	
			MacAdam 3step	SPHWAHDNK2VYZTVD2			

# D-series Premium color - Special color

- Fashion light effect: Clean, Elegant, Vivid
- Meat light effect: Fresh (Red), Delicious (Red), Vivid
- Vegetable light effect: Fresh, Delicious, Vivid

T <sub>j</sub> =85°C	LC013D	LC016D	LC019D	LC026D	LC033D
LES	9.8mm	14.5mm			
Typical	34.6 V				
	12.5W (360mA)	15.6W (450mA)	18.7W (540mA)	24.9W (720mA)	31.1W (900mA)
Max.	34.5W (920mA)	43.1W (1150mA)	51.8W (1380mA)	69.0W (1840mA)	86.2W (2300mA)
Size	13.5mm x 13.5mm	19mm x 19mm			

## Make the colors of objects whiter and more vivid

### Fashion



Whiteness, All saturated color↑  
Clean, Elegant, Vividness↑

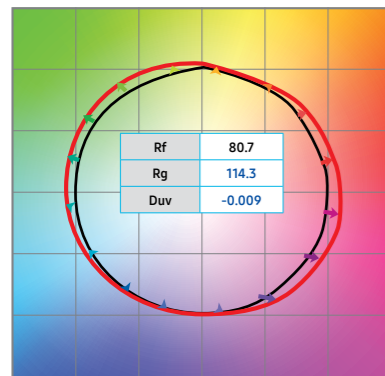

### Meat



Whiteness, Red saturated color↑  
Fresh, Delicious, Vividness↑

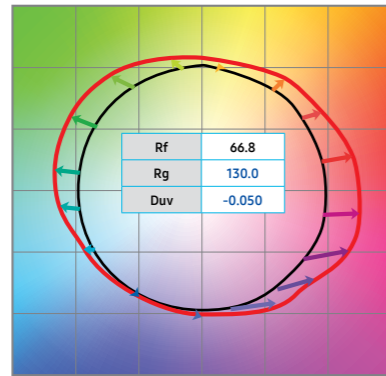

### Vegetable



Whiteness, Green & Red saturated color↑  
Fresh, Delicious, Vividness↑

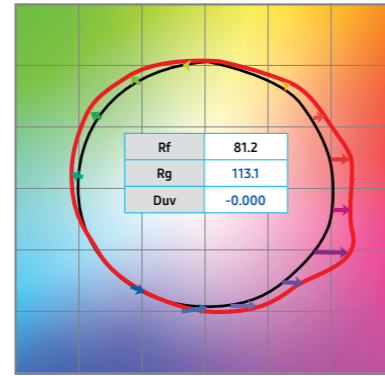

## Color Variation

Product	Fashion	Meat	Vegetable
LC013D	○	○	○
LC016D	○	○	○
LC019D	○	○	○
LC026D	○	○	○
LC033D	○	○	○
MacAdam 2-Step	○	○	○

## Specifications

Product	CRI	CCT (K)	Color rank	Part Number	T <sub>j</sub> = 85°C		I <sub>F</sub> (mA) V <sub>F</sub> (V)
					Luminous Flux Typ. (lm)	Luminous Efficacy Typ. (lm/W)	
 LC013D Premium color	Special color	Fashion	MacAdam 2step	SPHWAHDND2VYZUSD2	1085	1142	360mA 34.6V
		Meat	MacAdam 2step	SPHWAHDND2VYZTSD2	868	914	
		Vegetable	MacAdam 2step	SPHWAHDND2VYZRSD2	1128	1188	
 LC016D Premium color	Special color	Fashion	MacAdam 2step	SPHWAHDNE2VYZUSD2	1411	1485	450mA 34.6V
		Meat	MacAdam 2step	SPHWAHDNE2VYZTSD2	1129	1188	
		Vegetable	MacAdam 2step	SPHWAHDNE2VYZRSD2	1467	1544	
 LC019D Premium color	Special color	Fashion	MacAdam 2step	SPHWAHDNF2VYZUSD2	1677	1765	540mA 34.6V
		Meat	MacAdam 2step	SPHWAHDNF2VYZTSD2	1341	1412	
		Vegetable	MacAdam 2step	SPHWAHDNF2VYZRSD2	1744	1835	
 LC026D Premium color	Special color	Fashion	MacAdam 2step	SPHWAHDNG2VYZUSD2	2192	2307	720mA 34.6V
		Meat	MacAdam 2step	SPHWAHDNG2VYZTSD2	1753	1845	
		Vegetable	MacAdam 2step	SPHWAHDNG2VYZRSD2	2279	2399	
 LC033D Premium color	Special color	Fashion	MacAdam 2step	SPHWAHDNH2VYZUSD2	2712	2855	900mA 34.6V
		Meat	MacAdam 2step	SPHWAHDNH2VYZTSD2	2170	2284	
		Vegetable	MacAdam 2step	SPHWAHDNH2VYZRSD2	2820	2969	

**C-series** features a smaller LES (Light Emitting Surface) than the D-series, while providing a higher CBCP (Center Beam Candle Power) than its previous generation.



## High lumen density COB

Fits best into spot and down lighting applications which require a narrow beam



Standard COB



Small LES COB

## A wide range of wattage and CRI options

Platform	Model	Wattage				Key Features
		10W (LC010C)	20W (LC020C)	30W (LC030C)	40W (LC040C)	
		LES -In (LES-Out) Package	6.0mm (7.5mm) 13.5mm x 13.5mm	8.5mm (10.0mm) 19.0mm x 19.0mm	11.5mm (13.5mm) 19.0mm x 19.0mm	
C-series Gen 2	CRI 80+	●	●	●	●	<ul style="list-style-type: none"> <li>• Providing full options of CCT &amp; CRI</li> <li>• Best efficacy</li> <li>• Low thermal resistance by metal substrate</li> <li>• Easy holder design using same outline as D-series</li> </ul>
	CRI 90+	●	●	●	●	

## C-series Gen 2 [Small LES COB]

- Uses new flip chip technology
- Low droop to improve current and thermal performance
- High reliability
- Completed 6,000 hours of LM-80 testing

T <sub>j</sub> =85°C	LC010C Gen 2	LC020C Gen 2	LC030C Gen 2	LC040C Gen 2
LES	6.0mm	8.5mm	11.5mm	
Typical	35.0V			
	10.5W (300mA)	21.0W (600mA)	31.5W (900mA)	36.8W (1050mA)
Max.	13.8W (380mA)	34.0W (920mA)	51.1W (1380mA)	59.5W (1610mA)
Size	13.5mm x 13.5mm	19mm x 19mm	19mm x 19mm	19mm x 19mm



## Color Variation

Product	CRI90+					CRI80+				
	2700K	3000K	3500K	4000K	5000K	2700K	3000K	3500K	4000K	5000K
LC010C Gen 2	○	○	○	○	○	○	○	○	○	○
LC020C Gen 2	○	○	○	○	○	○	○	○	○	○
LC030C Gen 2	○	○	○	○	○	○	○	○	○	○
LC040C Gen 2	○	○	○	○	○	○	○	○	○	○
MacAdam 3-Step	○	○	○	○	○	○	○	○	○	○

## Specifications

Product	CRI	CCT (K)	Color rank	Part Number	T <sub>j</sub> = 85°C		I <sub>F</sub> (mA) V <sub>F</sub> (V)
					Luminous Flux Typ. (lm)	Luminous Efficacy Typ. (lm/W)	
 LC010C Gen 2	80+	2700K	MacAdam 3step	SPHWAHDNC25YZW3C2	1212	115	300mA 35.0V
		3000K	MacAdam 3step	SPHWAHDNC25YZV3C2	1274	121	
		3500K	MacAdam 3step	SPHWAHDNC25YZU3C2	1311	125	
		4000K	MacAdam 3step	SPHWAHDNC25YZT3C2	1337	127	
		5000K	MacAdam 3step	SPHWAHDNC25YZR3C2	1348	128	
	90+	2700K	MacAdam 3step	SPHWAHDNC27YZW3C2	1037	99	
		3000K	MacAdam 3step	SPHWAHDNC27YZV3C2	1091	104	
		3500K	MacAdam 3step	SPHWAHDNC27YZU3C2	1123	107	
		4000K	MacAdam 3step	SPHWAHDNC27YZT3C2	1147	109	
		5000K	MacAdam 3step	SPHWAHDNC27YZR3C2	1156	110	

## Specifications

Product	CRI	CCT (K)	Color rank	Part Number	$T_j = 85^\circ\text{C}$		$I_F$ (mA) $V_F$ (V)
					Luminous Flux Typ. (lm)	Luminous Efficacy Typ. (lm/W)	
 LC020C Gen 2	80+	2700K	MacAdam 3step	SPHWAHDNF25YZW3C2	2485	118	600mA 35.0V
		3000K	MacAdam 3step	SPHWAHDNF25YZV3C2	2625	125	
		3500K	MacAdam 3step	SPHWAHDNF25YZU3C2	2688	128	
		4000K	MacAdam 3step	SPHWAHDNF25YZT3C2	2742	131	
		5000K	MacAdam 3step	SPHWAHDNF25YZR3C2	2765	132	
	90+	2700K	MacAdam 3step	SPHWAHDNF27YZW3C2	2127	101	
		3000K	MacAdam 3step	SPHWAHDNF27YZV3C2	2237	107	
		3500K	MacAdam 3step	SPHWAHDNF27YZU3C2	2304	110	
		4000K	MacAdam 3step	SPHWAHDNF27YZT3C2	2351	112	
		5000K	MacAdam 3step	SPHWAHDNF27YZR3C2	2372	113	
 LC030C Gen 2	80+	2700K	MacAdam 3step	SPHWAHDNH25YZW3C2	3765	120	900mA 35.0V
		3000K	MacAdam 3step	SPHWAHDNH25YZV3C2	3956	126	
		3500K	MacAdam 3step	SPHWAHDNH25YZU3C2	4072	129	
		4000K	MacAdam 3step	SPHWAHDNH25YZT3C2	4154	132	
		5000K	MacAdam 3step	SPHWAHDNH25YZR3C2	4188	133	
	90+	2700K	MacAdam 3step	SPHWAHDNH27YZW3C2	3222	102	
		3000K	MacAdam 3step	SPHWAHDNH27YZV3C2	3389	108	
		3500K	MacAdam 3step	SPHWAHDNH27YZU3C2	3490	111	
		4000K	MacAdam 3step	SPHWAHDNH27YZT3C2	3562	113	
		5000K	MacAdam 3step	SPHWAHDNH27YZR3C2	3592	114	
 LC040C Gen 2	80+	2700K	MacAdam 3step	SPHWAHDNK25YZW3C2	4305	117	1050mA 35.0V
		3000K	MacAdam 3step	SPHWAHDNK25YZV3C2	4524	123	
		3500K	MacAdam 3step	SPHWAHDNK25YZU3C2	4657	127	
		4000K	MacAdam 3step	SPHWAHDNK25YZT3C2	4750	129	
		5000K	MacAdam 3step	SPHWAHDNK25YZR3C2	4790	130	
	90+	2700K	MacAdam 3step	SPHWAHDNK27YZW3C2	3684	100	
		3000K	MacAdam 3step	SPHWAHDNK27YZV3C2	3875	105	
		3500K	MacAdam 3step	SPHWAHDNK27YZU3C2	3991	109	
		4000K	MacAdam 3step	SPHWAHDNK27YZT3C2	4073	111	
		5000K	MacAdam 3step	SPHWAHDNK27YZR3C2	4108	112	

## Product Details

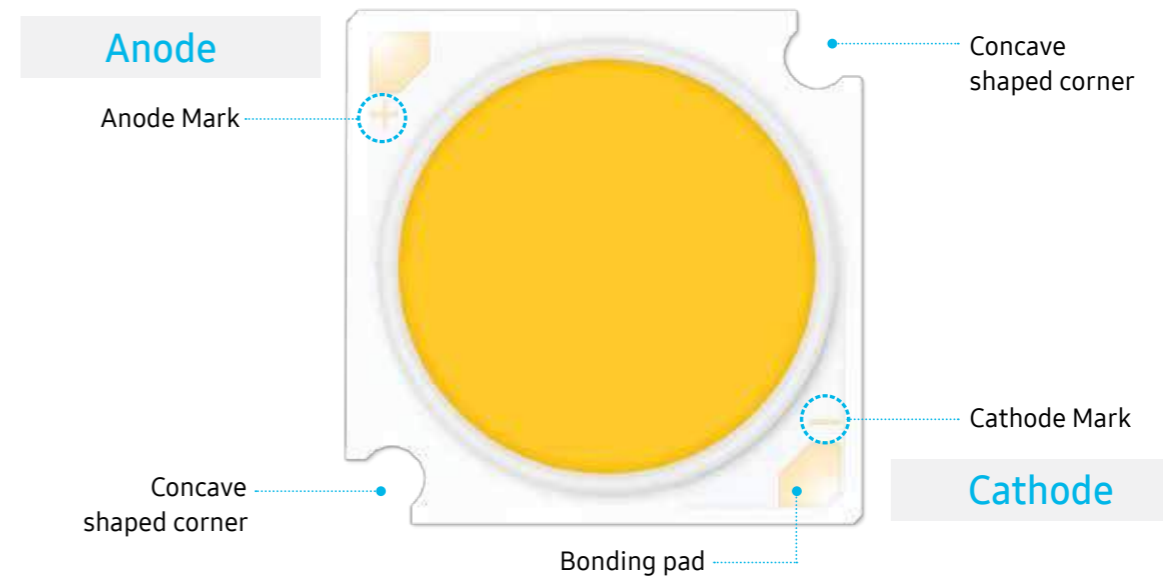

## Product Dimensions

### D-series

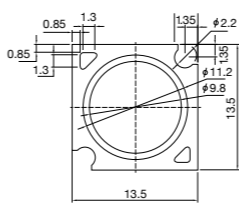
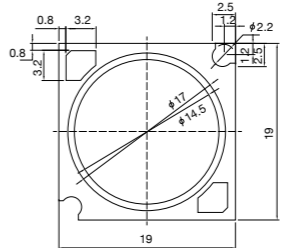
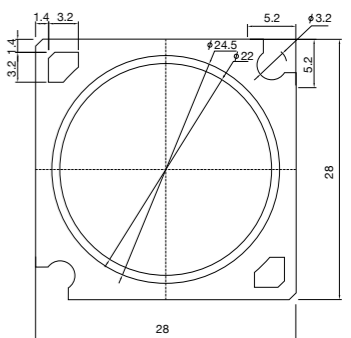
LC003D / LC006D / LC009D / LC013D	LC016D / LC019D / LC026D / LC033D	LC040D / LC060D / LC080D
		

### C-series

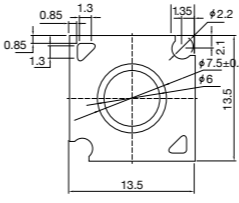
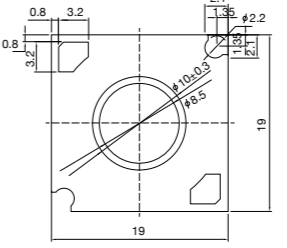
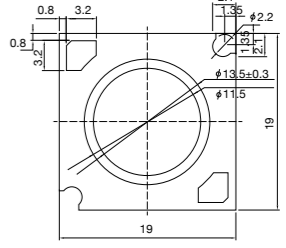
LC010C Gen 2	LC020C Gen 2	LC030C Gen 2 / LC040C Gen 2
		

## Simple Assembly for Your Lighting System



Field	Partners	Solutions
Optic	Alux Luxar, Wide germ Khatod, LEDil, Caclo, etc	Reflector (possible to be mounted on holders), Lens
Holder	Molex, TE, BJB, Bender Wirth, Stucchi, etc	Holder for fixation, Electrical connection
Thermal	Laired, TTM, Bergquist, etc	Thermal Interface Material (TIM) (Thermal Grease, thermal pad)
	Nuventix (Uniqest), etc	Heat sink

For up-to-dated list, visit [www.samsungled.com](http://www.samsungled.com)

## Certification Support Program

To provide more valuable services for your successful business

### Program Overview

#### Pre-Certification Test Support

Product structure, test and review by Samsung.  
Samsung is an accredited partner of UL, VDE & KOLAS

#### Certification Accreditations Support

- Customer support for **Cost and Test Period Saving for the EU, US & ASIA certification**
- Global certification program roll out soon to be available

### Customer Benefit

Certification	ETL, Energy Star, DLC <sup>1)</sup> , FCC, LM 79		KS/High Efficiency	PSE	S-Mark	CE, ErP, ENEC, ENEC+, EU Eco-Label, GS mark		CCC/CQC	
Customer Location	US	Korea/China		-		EU/US/Asia	China	Korea	China
Cost Discount	Testing	-20%	-30%	-30%	-30%	-20%	-30%	-20%	-30%
	Handling			-	-30%	-30%			
Test Period Savings	-30 ~ -50%	-30 ~ -50%	-20 ~ -30%			-20 ~ -30%	-20 ~ -30%	-20 ~ -30%	-20 ~ -30%
Company	Intertek		KTL (Korea Testing Laboratory)			TUV SUD		CCIC	
Branch	North America, China, Hong Kong, Korea		Korea, China			North America, Germany, China, Hong Kong, Singapore, Taiwan, Korea		Korea, China	

1) Energy Star, DLC's duration is not included for Lumen Maintenance test duration.  
2) Discount rate is based on the standard price of Companies.

### Process



Contact us : [www.samsung.com/global/business/led/contact-us](http://www.samsung.com/global/business/led/contact-us)