

SINGLE SUPPLY HIGH-SLEW RATE SINGLE OPERATIONAL AMPLIFIER

■ GENERAL DESCRIPTION

The NJM2716 is single supply single high slew rate operational amplifier.

It is applicable to A/D converters, FAX, scanner which require the single supply operation and high slew rate.

■ PACKAGE OUTLINE



NJM2716F

■ FEATURES

- Single Supply
- Operating Voltage +2.7V to 12V
- Operating Current 5.5mA max.
- High Slew Rate 40V/ μ s typ.
- Bipolar Technology
- Package Outline SOT-23-5

■ PIN CONFIGURATION

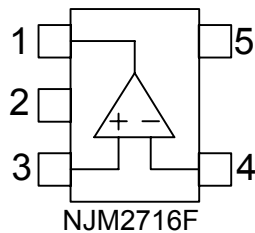

PIN FUNCTION

- 1.OUTPUT
- 2.GND
- 3.+INPUT
- 4.-INPUT
- 5.V⁺

■ EQUIVALENT CIRCUIT

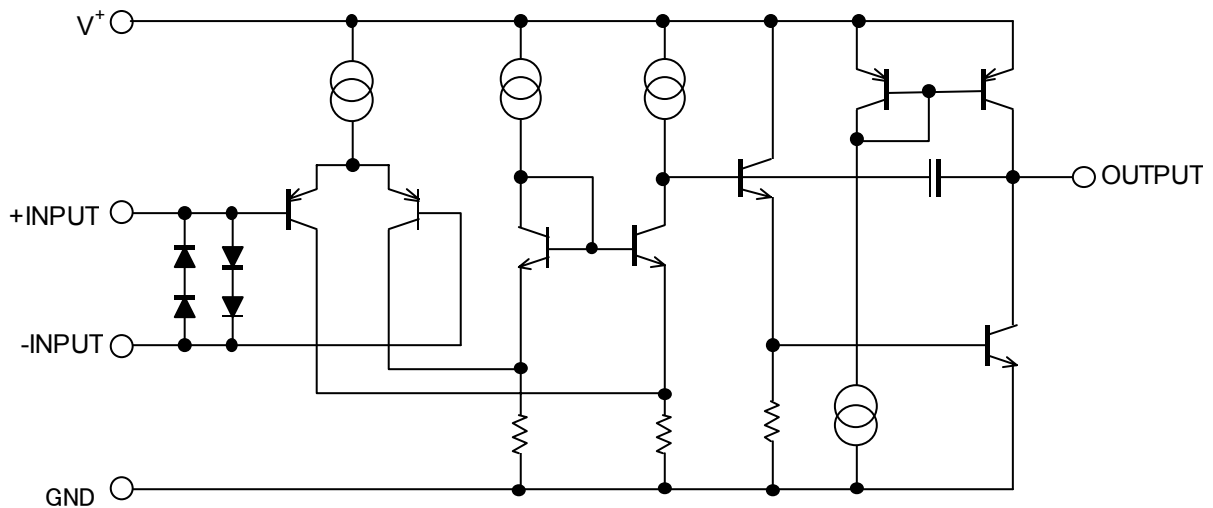

NJM2716

■ ABSOLUTE MAXIMUM RATINGS

(Ta=25°C)

PARAMETER	SYMBOL	RATINGS	UNIT
Supply Voltage	V ⁺	15.0	V
Power Dissipation	P _D	200	mW
Differential Input Voltage	V _{ID}	±3	V
Input Voltage	V _{IC}	-0.3 to +15 (note)	V
Output Sink Current	I _{SINK}	10	mA
Operating Temperature Range	T _{opr}	-40 to +85	°C
Storage Temperature Range	T _{stg}	-40 to +125	°C

(note) When supply voltage is less than 15V, the absolute maximum input voltage is equal to the supply voltage.

■ ELECTRICAL CHARACTERISTICS (V⁺=5V, Ta=25°C)

PARAMETER	SYMBOL	TEST CONDITION	MIN.	TYP.	MAX.	UNIT
Input Offset Voltage	V _{IO}	R _s =0Ω	-	1	10	mV
Input Offset Current	I _{IO}		-	0.2	0.5	μA
Input Bias Current	I _B		-	1	2.5	μA
Voltage Gain	A _V	R _L ≥10kΩ	60	75	-	dB
Input Common Mode Voltage Range	V _{ICM}		0 to 3.8	-	-	V
Common Mode Rejection Ratio	CMR		45	80	-	dB
Supply Voltage Rejection Ratio	SVR		50	75	-	dB
Maximum Output Voltage1	V _{OM} ⁺¹	R _L =4kΩ to GND	4.3	4.5	-	V
	V _{OM} ⁻¹		-	0.05	0.1	
Maximum Output Voltage 2	V _{OM} ⁺²	R _L =4kΩ to 2.5V	4.5	4.7	-	V
	V _{OM} ⁻²		-	0.1	0.5	
Output Source Current	I _{SOURCE}		1	2.5	-	mA
Output Sink Current	I _{SINK}		2.5	5	-	mA
Operating Current	I _{CC}	R _L =∞	-	4.2	5.5	mA
Slew Rate	SR		-	40	-	V/μs
Unity Gain Bandwidth	f _T		-	30	-	MHz

Ver.5

■ TYPICAL CHARACTERISTICS

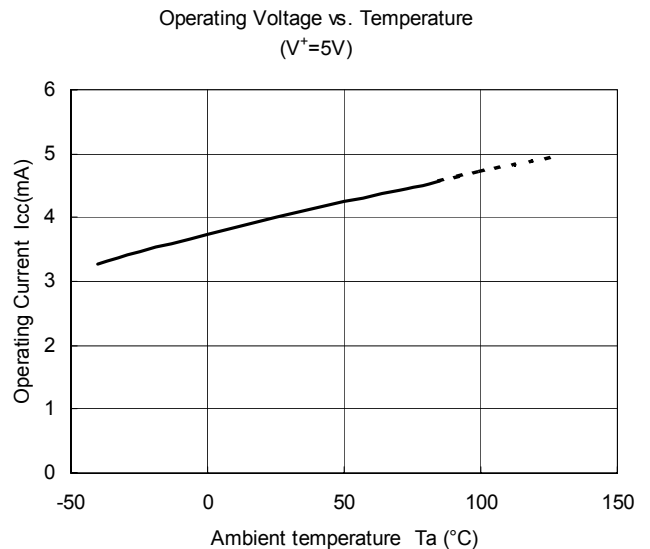
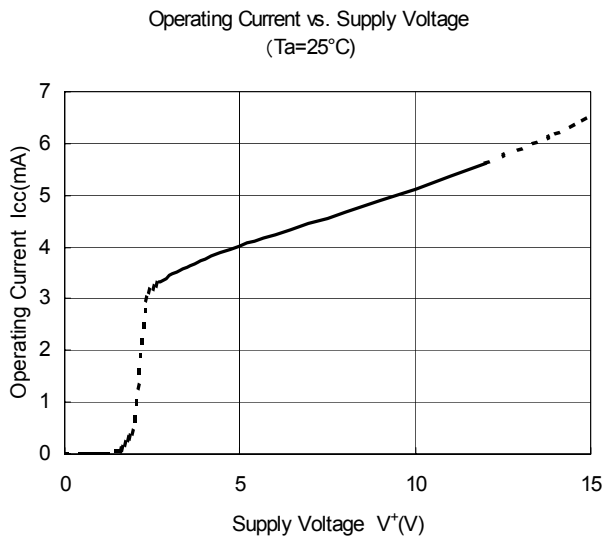
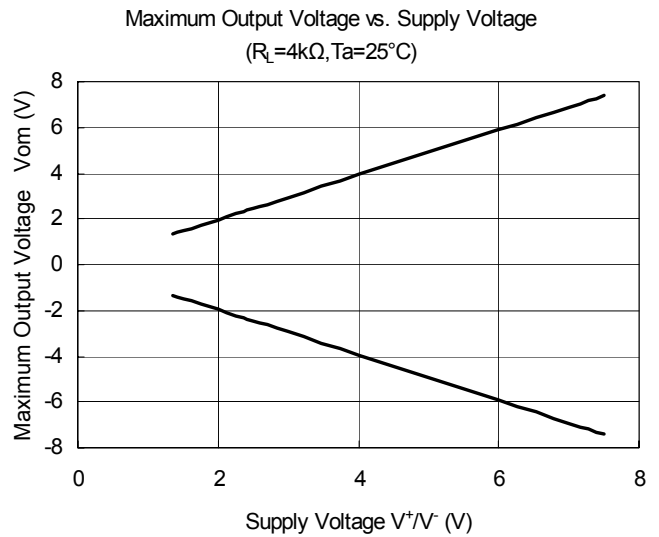
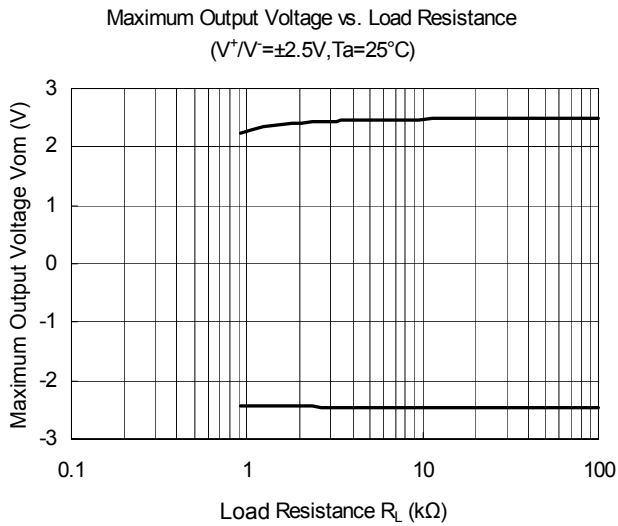
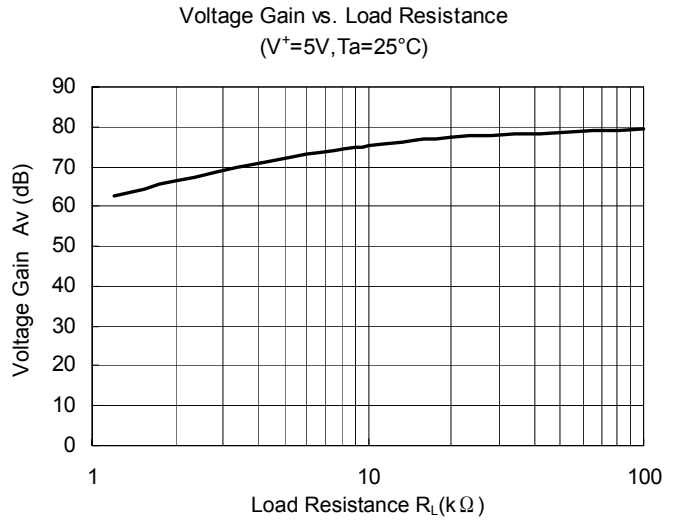
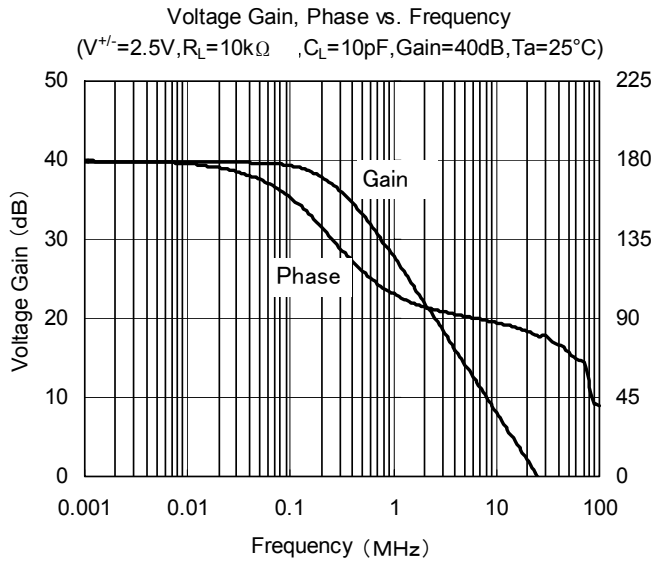

TYPICAL CHARACTERISTICS

Output Voltage vs. Output Sink Current
($V^+/V^- = \pm 2.5V, T_a = 25^\circ C$)

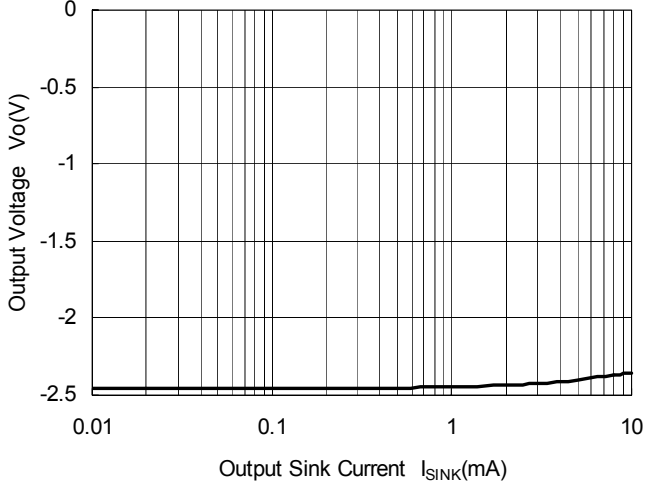

Output Voltage vs. Output Source Current
($V^+/V^- = \pm 2.5V, T_a = 25^\circ C$)

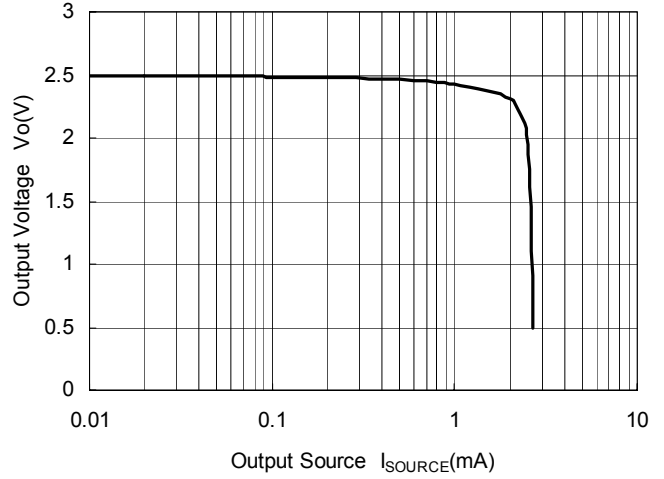

Input Offset Voltage vs. Temperature
($V^+ = 5V$)

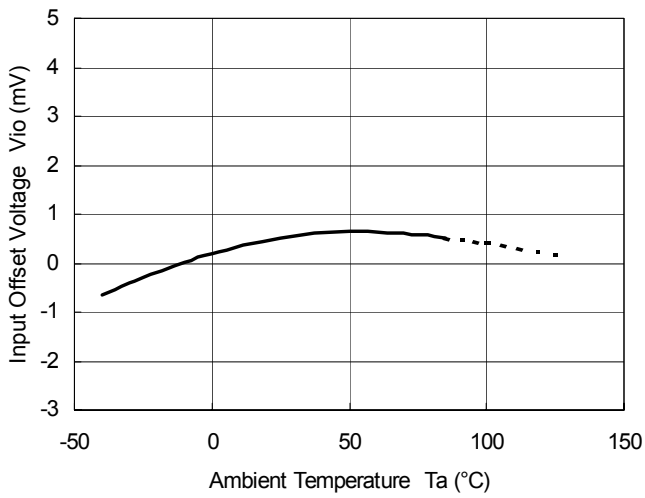

Output Voltage vs. Time
($V^+/V^- = \pm 2.5V, V_{in} = 2V_{pp}, f = 1MHz, R_L = 10k\Omega, C_L = 10pF, A_v = 0dB$)

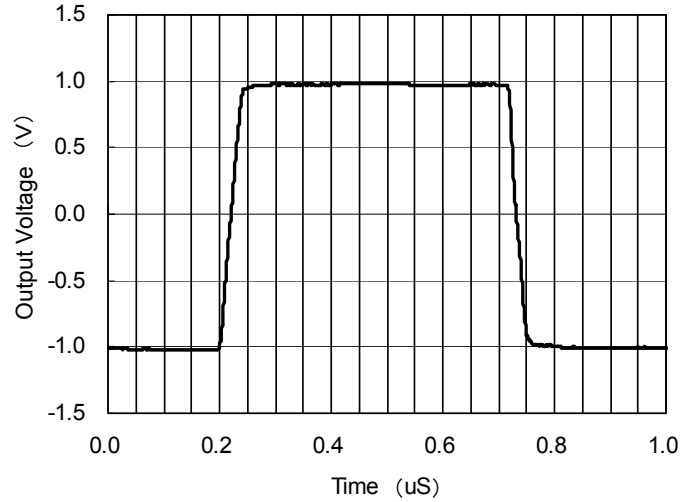

MEMO

[CAUTION]
The specifications on this databook are only given for information , without any guarantee as regards either mistakes or omissions. The application circuits in this databook are described only to show representative usages of the product and not intended for the guarantee or permission of any right including the industrial rights.