

ADQ600-48S12

600 Watts

Quarter-brick Converter

Total Power: 600 Watts
Input Voltage: 40 to 60 Vdc
of Outputs: Single

Special Features

- Delivering up to 50A output
- Ultra-high efficiency 95.6% typ. at full load
- Wide input range: 40V ~ 60V
- Excellent thermal performance
- No minimum load requirement
- Basic isolation
- High power density
- Low output noise
- RoHS 6 compliant
- Remote control function (negative logic)
- Input under voltage lockout
- Output over current protection
- Output over voltage protection
- Over temperature protection
- Industry standard quarter-brick pin-out outline
- Open-frame and baseplated
- Pin length option: 3.8mm

Safety

IEC/EN/UL/CSA 60950
CE Mark
UL/TUV
Materials meet UL94, V-0
EN55022 ClassB



Product Descriptions

The ADQ600-48S12 is a single output DC-DC converter with standard quarter-brick outline and pin configuration. It delivers up to 50A output current with 12V output voltage. Ultra-high 95.6% efficiency and excellent thermal performance makes it an ideal choice for use in datacom and telecommunication applications and can work under -40 °C ~ +85 °C.

Applications

Telecom/ Datacom

Model Numbers

Standard	Output Voltage	Structure	Remote ON/OFF logic	RoHS Status
ADQ600-48S12-6L	12Vdc	Open-frame	Negative	R6
ADQ600-48S12B-6L	12Vdc	Baseplated	Negative	R6

Ordering information

ADQ600	-	48	S	12	B	-	6	L
①		②	③	④	⑤		⑥	⑦

①	Model series	ADQ: high efficiency sixteenth brick series, 600: output power 600W
②	Input voltage	48: 40V ~ 60V input range, rated input voltage 48V
③	Output number	S: single output
④	Rated output voltage	12: 12V output
⑤	Baseplate	B: with baseplate; default: open frame
⑥	Pin length	S: SMT; 6: 3.8mm ± 0.25mm pin length
⑦	RoHS status	Y: Rohs, R5; L: RoHS, R6

Options

None

Electrical Specifications

Absolute Maximum Ratings

Stress in excess of those listed in the “Absolute Maximum Ratings” may cause permanent damage to the power supply. These are stress ratings only and functional operation of the unit is not implied at these or any other conditions above those given in the operational sections of this TRN. Exposure to any absolute maximum rated condition for extended periods may adversely affect the power supply’s reliability.

Table 1. Absolute Maximum Ratings:

Parameter	Model	Symbol	Min	Typ	Max	Unit
Input Voltage Operating –Continuous Non-operating 100ms	All	$V_{IN,DC}$	-	-	63	Vdc
			-	-	80	Vdc
Maximum Output Power	All	$P_{O,max}$	-	-	600	W
Isolation Voltage ¹ Input to outputs	All		1500	-	-	Vdc
Ambient Operating Temperature	All	T_A	-40	-	+85	°C
Storage Temperature	All	T_{STG}	-55	-	+125	°C
Voltage at remote ON/OFF pin	All		-0.3	-	12	Vdc
Humidity (non-condensing) Operating Non-operating	All		-	-	95	%
	All		-	-	95	%

Note: 1 - 1mA for 60s, slew rate of 2000V/10s

Input Specifications

Table 2. Input Specifications:

Parameter	Conditions ¹	Symbol	Min	Typ	Max	Unit
Operating Input Voltage, DC	All	$V_{IN,DC}$	40	48	60	Vdc
Turn-on Voltage Threshold	$I_O = I_{O,max}$	$V_{IN,ON}$	-	39	-	Vdc
Turn-off Voltage Threshold	$I_O = I_{O,max}$	$V_{IN,OFF}$	-	37	-	Vdc
Lockout Voltage Hysteresis	$I_O = I_{O,max}$		-	2	-	V
Input OVP	$I_O = I_{O,max}$	V_{IN}	-	64	-	V
Input recovery voltage	$I_O = I_{O,max}$	V_{IN}	-	62	-	V
Maximum Input Current ($I_O = I_{O,max}$)	$V_{IN,DC} = 40V_{DC}$	$I_{IN,max}$	-	-	16.2	A
No Load Input Current	$I_O = 0A$	I_{IN}	-	0.16	-	A
Standby Input Current	Remote Off	I_{IN}	-	0.01	0.1	A
Recommended Input Fuse	Fast blow external fuse recommended		-	-	30	A
Recommended External Input Capacitance	Low ESR capacitor recommended	C_{IN}		220	-	uF
Input Reflected Ripple Current	Through 12uH inductor		-	70	-	mA
Input Filter Component Value(C\L)	Internal values		-	9.4\3.3	-	μF\μH
Operating Efficiency	$T_A = 25\text{ }^\circ\text{C}$ $I_O = I_{O,max}$ $I_O = 50\%I_{O,max}$	η	-	95.6	-	%
			-	95	-	%

Note 1 - $T_a = 25\text{ }^\circ\text{C}$, airflow rate = 400 LFM, $V_{in} = 48V_{dc}$, nominal V_{out} unless otherwise noted.

Output Specifications

Table 3. Output Specifications:

Parameter	Condition ¹	Symbol	Min	Typ	Max	Unit	
Factory Set Voltage	$V_{IN,DC} = 48V_{DC}$ $I_O = I_{O,max}$	V_O	11.68	11.80	11.92	Vdc	
Total Regulation	Inclusive of line, load temperature change, warm-up drift	V_O	11.68	12.00	12.32	Vdc	
Output Voltage Line Regulation	All	$\%V_O$	-	0.1	0.9	%	
Output Voltage Load Regulation	All	$\%V_O$	-	3.3	-	%	
Output Voltage Temperature Regulation	All	$\%V_O$	-	0.002	0.02	$\%/^{\circ}C$	
Output Ripple, pk-pk	Measure with a 1uF ceramic capacitor in parallel with a 10uF tantalum capacitor, 0 to 20MHz bandwidth	V_O	-	200	-	mV _{PK-PK}	
Output Current	All	I_O	0	-	50	A	
Output DC current-limit inception ²		I_O	55	-	70	A	
V_O Load Capacitance ³	All	C_O	470	-	5000	uF	
V_O Dynamic Response	Peak Deviation Settling Time	25%~50%~75% $I_{O,max}$ slew rate = 0.1A/us	$\pm V_O$	-	200	-	mV
		T_s	-	200	-	uSec	
		50%~75%~50% $I_{O,max}$ slew rate = 0.1A/us	$\pm V_O$	-	200	-	mV
			T_s	-	200	-	uSec
Turn-on transient	Rise time	$I_O = I_{max}$	T_{rise}	-	10	50	mS
	Turn-on delay time	$I_O = I_{max}$	$T_{turn-on}$	-	50	100	mS
	Output voltage overshoot	$I_O = 0$	$\%V_O$	-	0	-	%
Isolation Voltage	Input to outputs	1mA for 60s Slew rate of 1500V/10s		1500	-	-	Vdc
Switching frequency	All	f_{sw}	-	175	-	KHz	
Remote ON/OFF control (positive logic)	Off-state voltage	All		-0.3	-	1.2	V
	On-state voltage	All		3.5	-	12	V

Note 1 - $T_a = 25^{\circ}C$, airflow rate = 400 LFM, $V_{in} = 48V_{dc}$, nominal V_{out} unless otherwise noted.

Note 2 - Hiccup: auto-restart when over-current condition is removed.

Note 3 - High frequency and low ESR is recommended.

Output Specifications

Table 3. Output Specifications, con't:

Parameter		Condition	Symbol	Min	Typ	Max	Unit
Remote ON/OFF control (Negative logic)	Off-state voltage	All		3.5	-	12	V
	On-state voltage	All		-0.3	-	1.2	V
Output over-voltage protection ⁴		All		13.6	-	16	V
Output over-temperature protection ⁵		ADQ600-48S12-6L	T	-	125	130	°C
		ADQ600-48S12B-6L	T	-	110	120	°C
Over-temperature hysteresis		All	T	10	-	-	°C
MTBF		Telcordia SR-332-2006; 80% load, 300LFM, 40 °C T _A		-	1.5	-	10 ⁶ h

Note 4 - Hiccup: auto-restart when over-voltage condition is removed.

Note 5 - Auto recovery.

ADQ600-48S12-6L Performance Curves

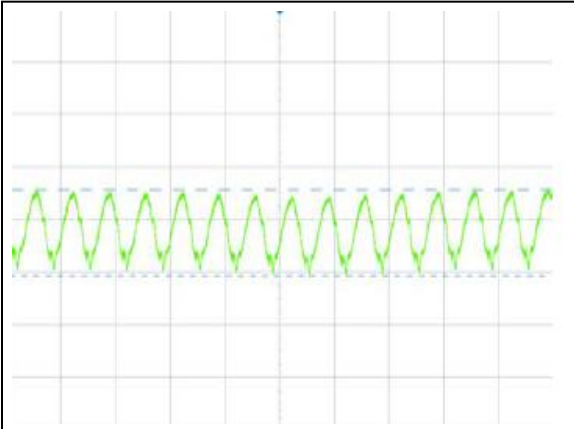

Figure 1: ADQ600-48S12-6L Input Reflected Ripple Current Waveform
Ch : Iin (5µs/div, 40mA/div)

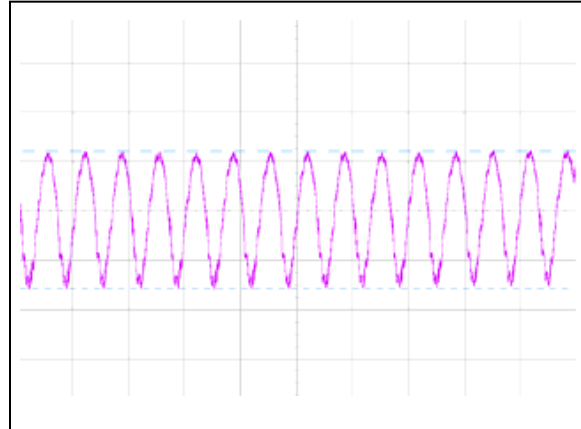

Figure 2: ADQ600-48S12-6L Ripple and Noise Measurement
Ch : Vo (5µs/div, 30mV/div)

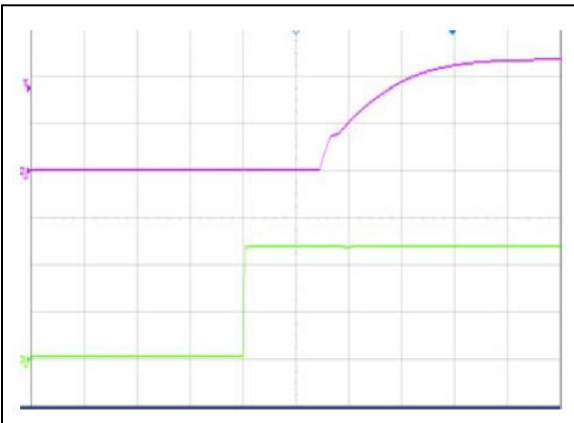

Figure 3: ADQ600-48S12-6L Startup Characteristic(20ms/div)
Ch 2: Vo (5V/div) Ch 3: Vin (20V/div)

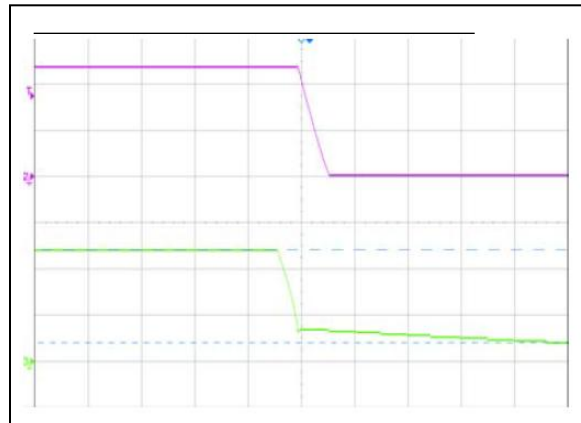

Figure 4: ADQ600-48S12-6L Turn Off Characteristic (5ms/div)
Ch 2: Vo (5V/div) Ch 3: Vin (20V/div)

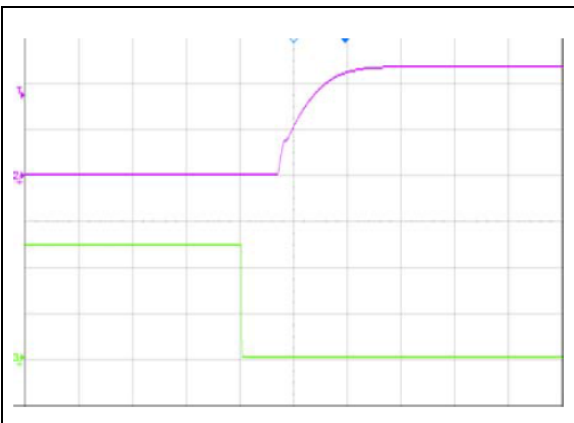

Figure 5: ADQ600-48S12-6L Remote ON Waveform (10ms/div)
Ch 2: Vo (5V/div) Ch 3: Remote ON (2V/div)

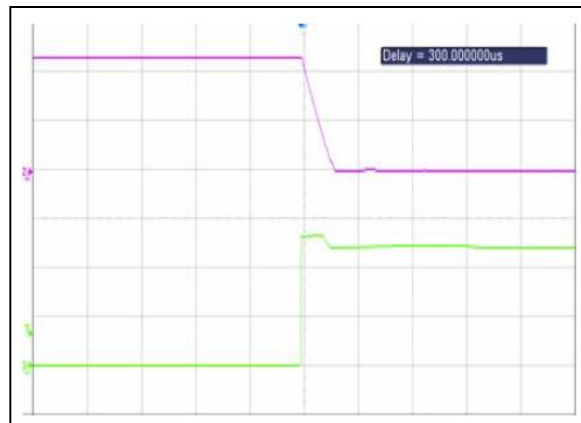

Figure 6: ADQ600-48S12-6L Remote OFF Waveform (20ms/div)
Ch 2: Vo (5V/div) CH3: Remote OFF (2V/div)

ADQ600-48S12-6L Performance Curves

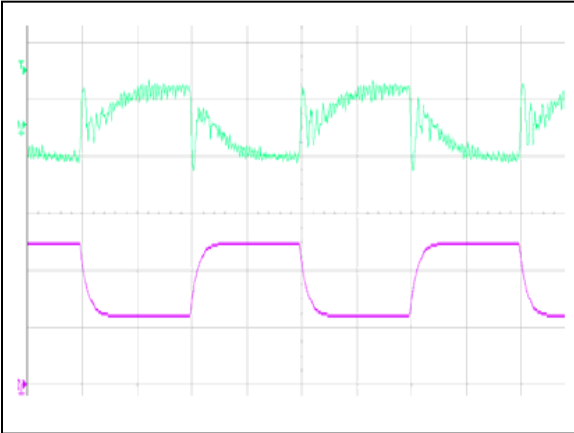

Figure 7: ADQ600-48S12-6L Transient Response (2mS/div)
25% load step(25%~50%~25%)
Ch 4: Vo (100mV/div) Ch 2: Io (10A/div)

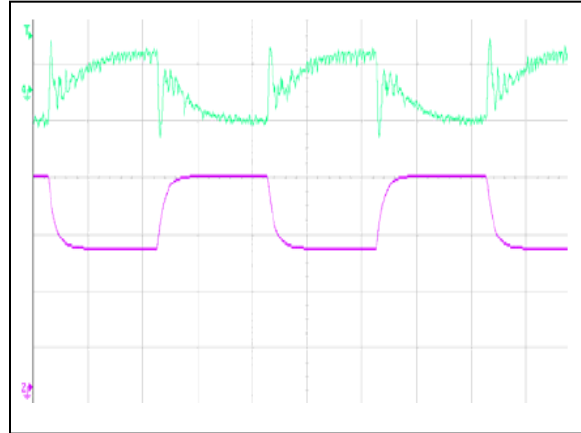

Figure 8: ADQ600-48S12-6L Transient Response (2mS/div)
50% load step(50%~75%~50%)
Ch 4: Vo (100mV/div) Ch 3: Io (10A/div)

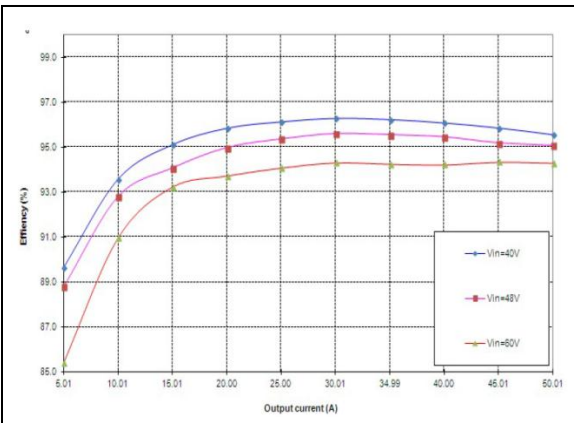

Figure 9: ADQ600-48S12-6L Efficiency Curves @ 25 °C

Loading: Io = 10% increment to 50A

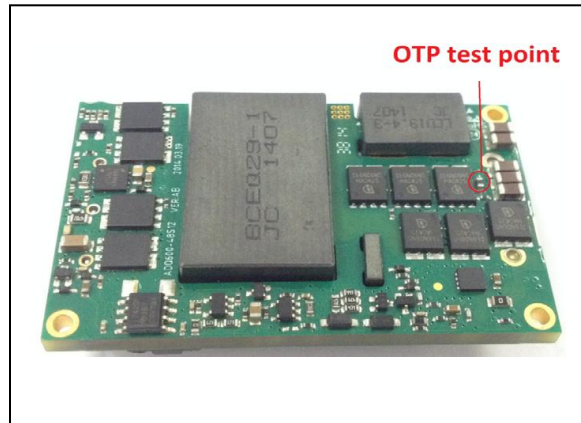

Figure 10: ADQ600-48S12-6L Over Temperature Protection Test Point

ADQ600-48S12B-6L Performance Curves

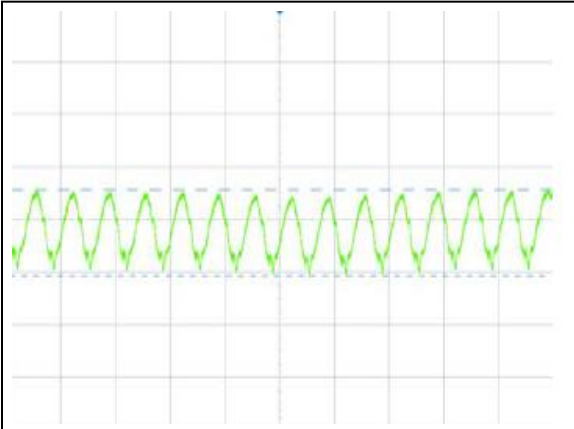

Figure 11: ADQ600-48S12B-6L Input Reflected Ripple Current Waveform
Ch : Iin (5uS/div, 40mA/div)

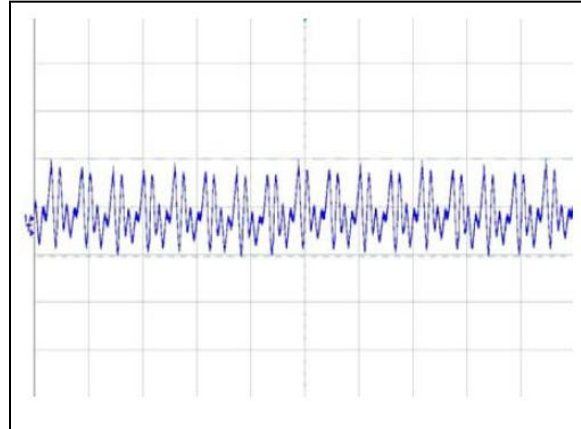

Figure 12: ADQ600-48S12B-6L Ripple and Noise Measurement
Ch : Vo (5uS/div, 20mV/div)

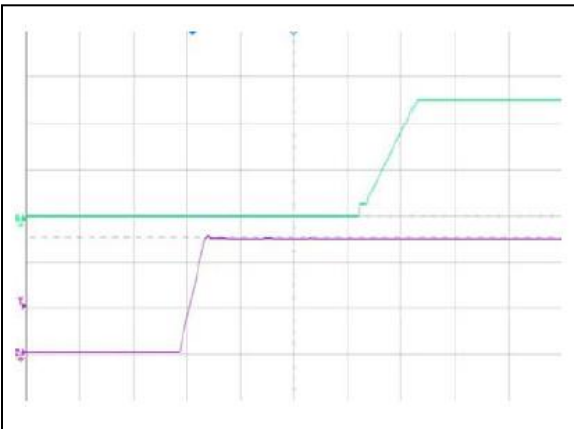

Figure 13: ADQ600-48S12B-6L Startup Characteristic(20mS/div)
Ch 2: Vo (5V/div) Ch 3: Vin (20V/div)

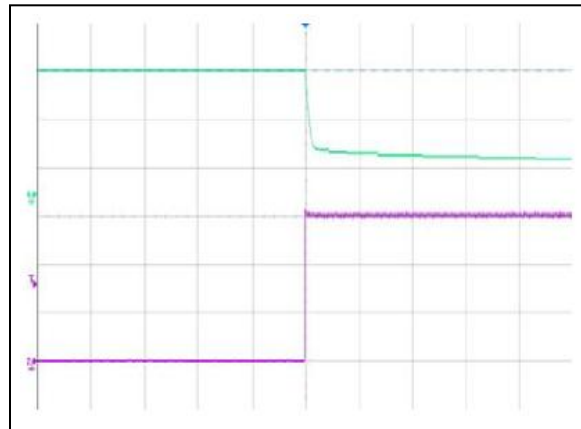

Figure 14: ADQ600-48S12B-6L Turn Off Characteristic (5mS/div)
Ch 2: Vo (5V/div) Ch 3: Vin (20V/div)

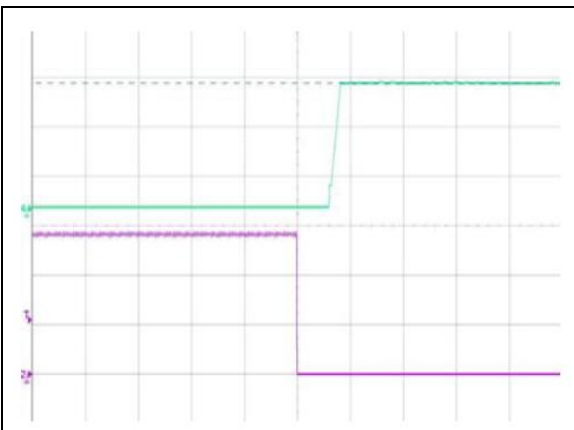

Figure 15: ADQ600-48S12B-6L Remote ON Waveform (10mS/div)
Ch 2: Vo (5V/div) Ch 3: Remote ON (2V/div)

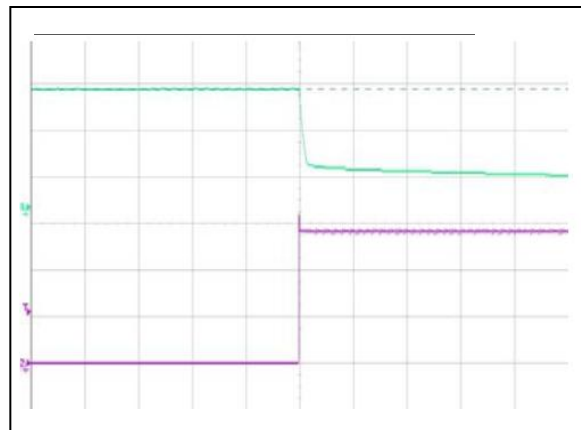

Figure 16: ADQ600-48S12B-6L Remote OFF Waveform (20mS/div)
Ch 2: Vo (5V/div) CH3: Remote OFF (2V/div)

ADQ600-48S12B-6L Performance Curves

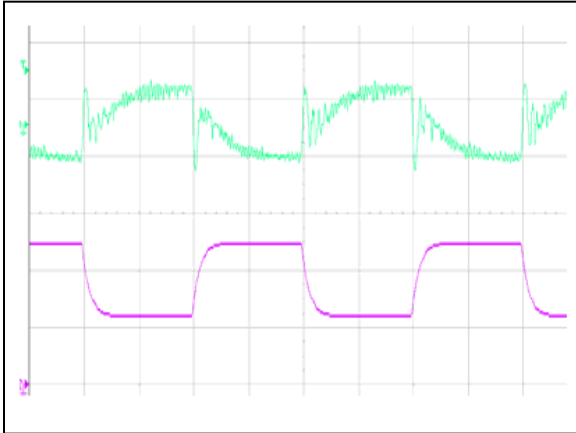

Figure 17: ADQ600-48S12B-6L Transient Response (2mS/div)
25% load step(25%-50%-25%)
Ch 4: Vo (100mV/div) Ch 2: Io (10A/div)

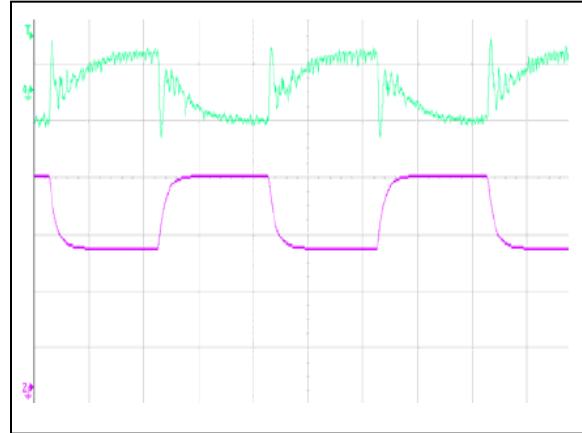

Figure 18: ADQ600-48S12B-6L Transient Response (2mS/div)
50% load step(50%-75%-50%)
Ch 4: Vo (100mV/div) Ch 3: Io (10A/div)

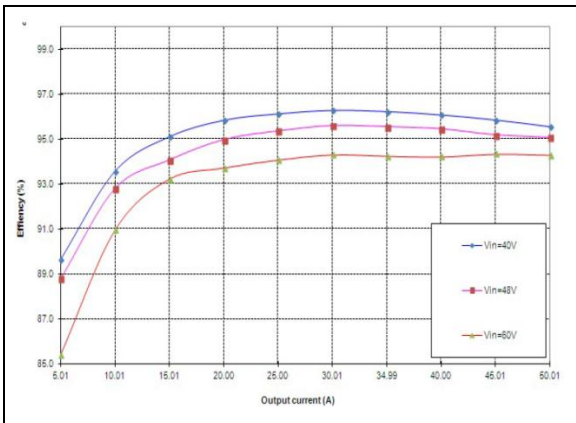

Figure 19: ADQ600-48S12B-6L Efficiency Curves @ 25 degC Loading:
Io = 10% increment to 50A

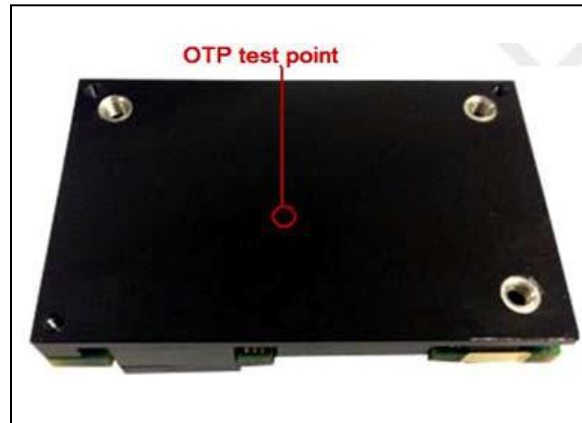
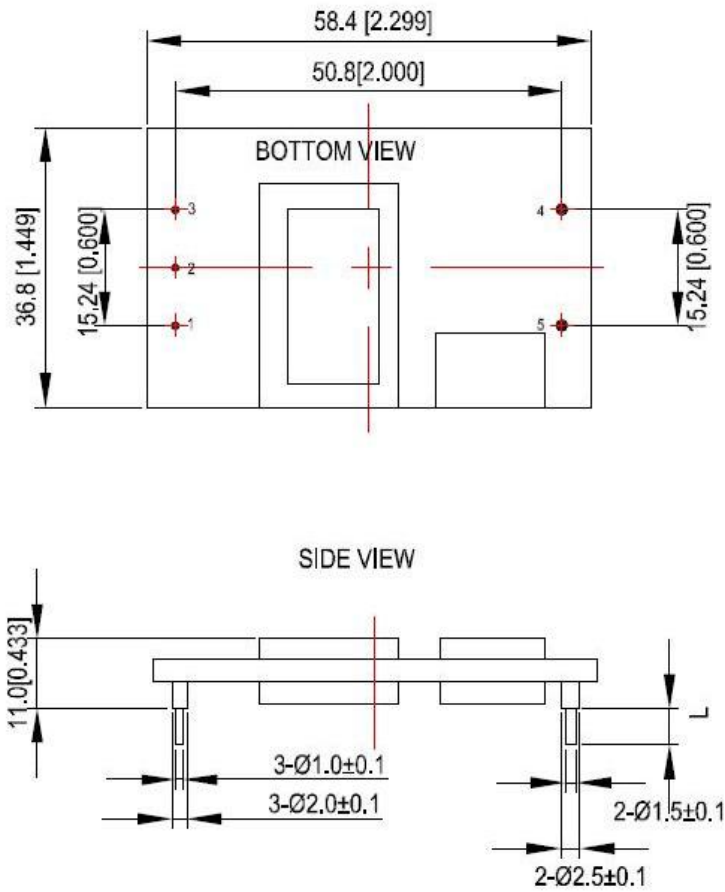

Figure 20: ADQ600-48S12B-6L Over Temperature Protection Test Point

Mechanical Specifications

Mechanical Outlines- Open Frame Module



UNIT: mm[inch]

BOTTOM VIEW: pin on upside

TOLERANCE: X.Xmm±0.5mm[X.X in.±0.02in.]

X.XXmm±0.25mm[X.XX in.±0.01in.]

Mechanical Outlines- Baseplate Module

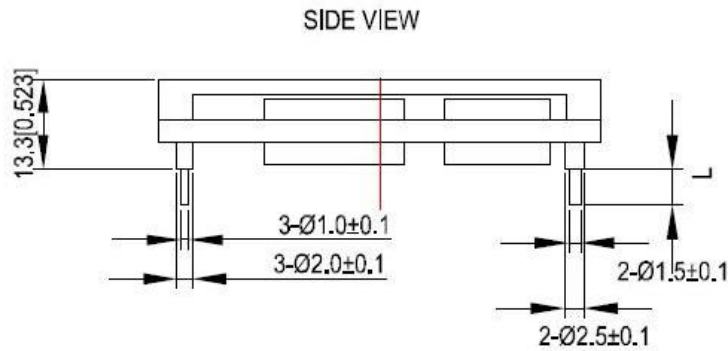
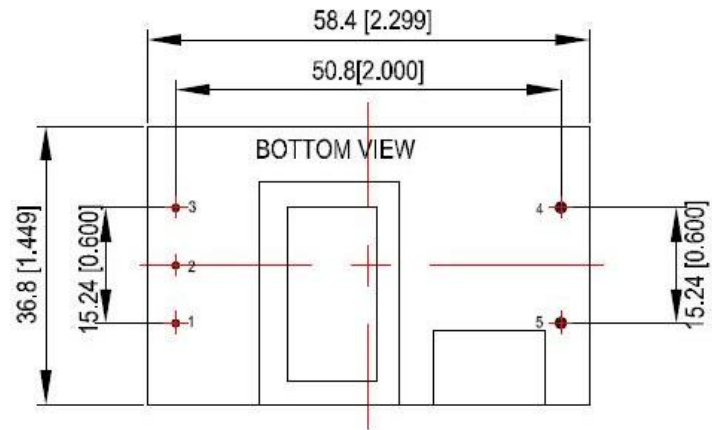

UNIT: mm[inch]

BOTTOM VIEW: pin on upside

TOLERANCE: X.Xmm±0.5mm[X.X in.±0.02in.]

X.XXmm±0.25mm[X.XX in.±0.01in.]

Device code suffix	L
-4	4.8mm ± 0.25 mm
-6	3.8mm ± 0.25 mm
-8	2.8mm ± 0.25 mm
None	5.8mm ± 0.25 mm

Pin Designations

Pin No	Name	Function
1	Vin+	Positive input voltage
2	Remote On/Off	Remote control
3	Vin-	Negative input voltage
4	Vo-	Negative output voltage
5	Vo+	Positive output voltage

Environmental Specifications

EMC Immunity

ADQ600-48S12 power supply is designed to meet the following EMC immunity specifications:

Table 4. Environmental Specifications:

Document	Description	Criteria
EN55022, Class A Limits	Conducted and Radiated EMI Limits	/
IEC/EN 61000-4-2, Level 3	Electromagnetic Compatibility (EMC) - Testing and measurement techniques - Electrostatic discharge immunity test. Enclosure Port	B
IEC/EN 61000-4-6, Level 2	Electromagnetic Compatibility (EMC) - Testing and measurement techniques, Continuous Conducted Interference. DC input port	A
IEC/EN 61000-4-4, Level3	Electromagnetic Compatibility (EMC) - Testing and measurement techniques, Electrical Fast Transient. DC input port.	B
IEC/EN 61000-4-5	Electromagnetic Compatibility (EMC) - Testing and measurement techniques, Immunity to surges - 600V common mode and 600V differential mode for DC ports	B
EN61000-4-29	Electromagnetic Compatibility (EMC) - Testing and measurement techniques, Voltage Dips and short interruptions and voltage variations. DC input port	B

Criterion A: Normal performance during and after test.

Criterion B: For EFT and surges, low-voltage protection or reset is not allowed. Temporary output voltage fluctuation ceases after disturbances ceases, and from which the EUT recovers its normal performance automatically. For Dips and ESD, output voltage fluctuation or reset is allowed during the test, but recovers to its normal performance automatically after the disturbance ceases.

Recommend EMC Filter Configuration

See figure 27

Safety Certifications

The ADQ600-48S12 power supply is intended for inclusion in other equipment and the installer must ensure that it is in compliance with all the requirements of the end application. This product is only for inclusion by professional installers within other equipment and must not be operated as a stand alone product.

Table 5. Safety Certifications for ADQ600-48S12 power supply system

Document	File #	Description
UL/CSA 60950		US and Canada Requirements
EN60950		European Requirements
IEC60950		International Requirements
CE		CE Marking

Operating Temperature

The ADQ600-48S12 power supply will start and operate within stated specifications at an ambient temperature from 40 °C to 85 °C under all load conditions. The storage temperature is -55 °C to 125 °C.

Thermal Considerations – Open-frame module(ADQ600-48S12-6L)

The converter is designed to operate in different thermal environments and sufficient cooling must be provided. Proper cooling of the DC/DC converter can be verified by measuring the temperature at the test point as shown in the Figure 21. The temperature at this point should not exceed the max values in the table 6.



Figure 21 Temperature test point

Table 6. Temperature limit of the test point

Test Point	Temperature Limit
Test point 1	125 °C
Test point 2 (PCB)	122 °C

For a typical application, Figure 22 shows the derating of output current vs. ambient air temperature at different air velocity.

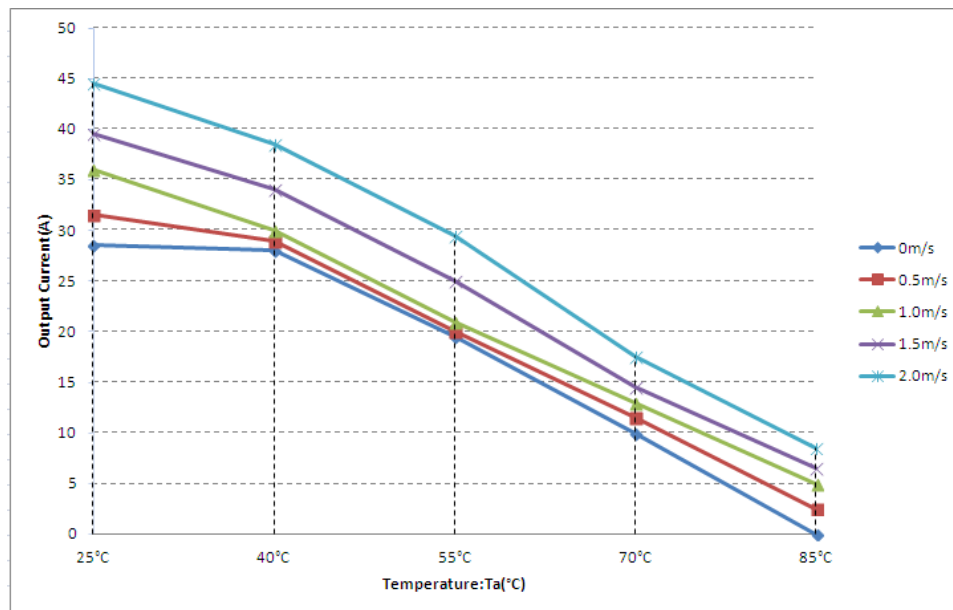

Figure 22 Output power derating, 48Vin, air flowing across the converter from Vin- to Vin+

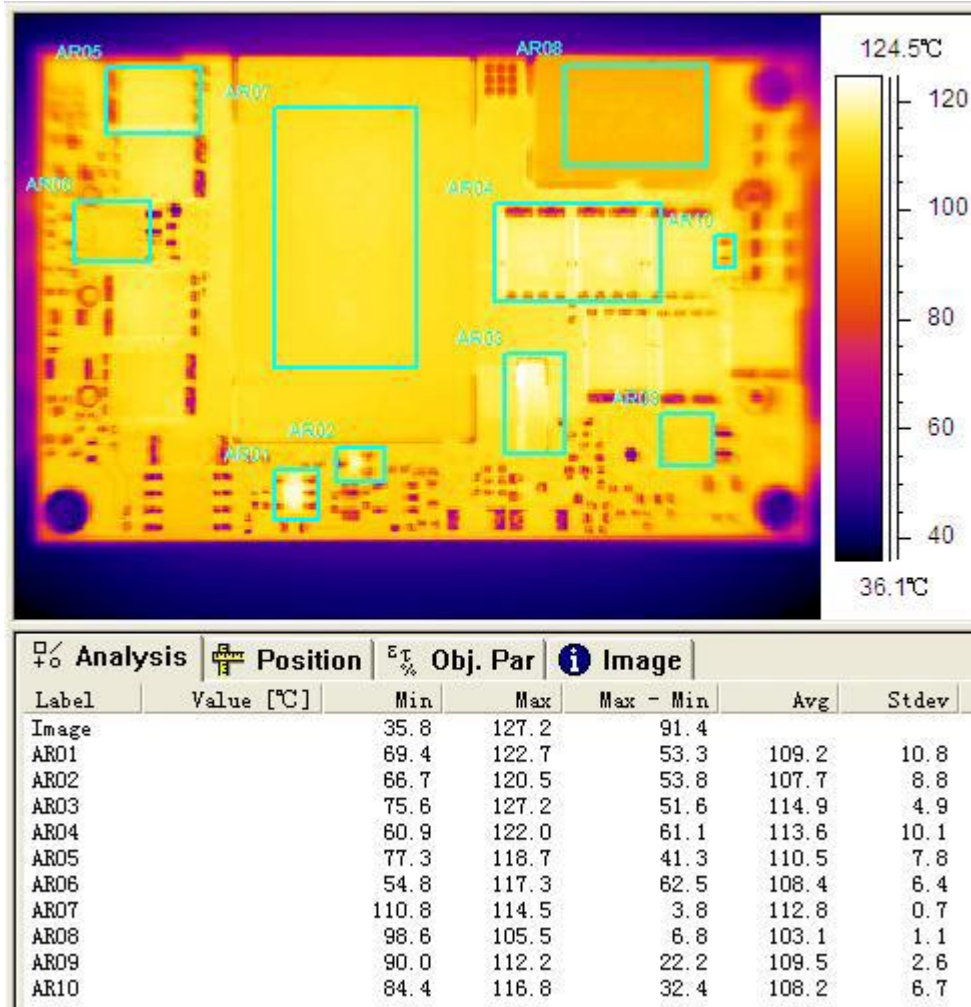

Figure 23 Thermal image, 48Vin, 12Vo, full load, room temperature

Thermal Considerations – Baseplated module(ADQ600-48S12B-6L)

The converter is designed to operate in different thermal environments and sufficient cooling must be provided. Proper cooling of the DC/DC converter can be verified by measuring the temperature at the test point as shown in the Figure 24. The temperature at this point should not exceed the max values in the table 7.



Figure 24 Temperature test point

Table 7. Temperature limit of the test point

Test Point	Temperature Limit
Test point 1	125 °C
Test point 2 (PCB)	122 °C

For a typical application, figure 26 shows the derating of output current vs. ambient air temperature at different air velocity @48V input with a specified heatsink. The typical test condition is shown in Figure 25.

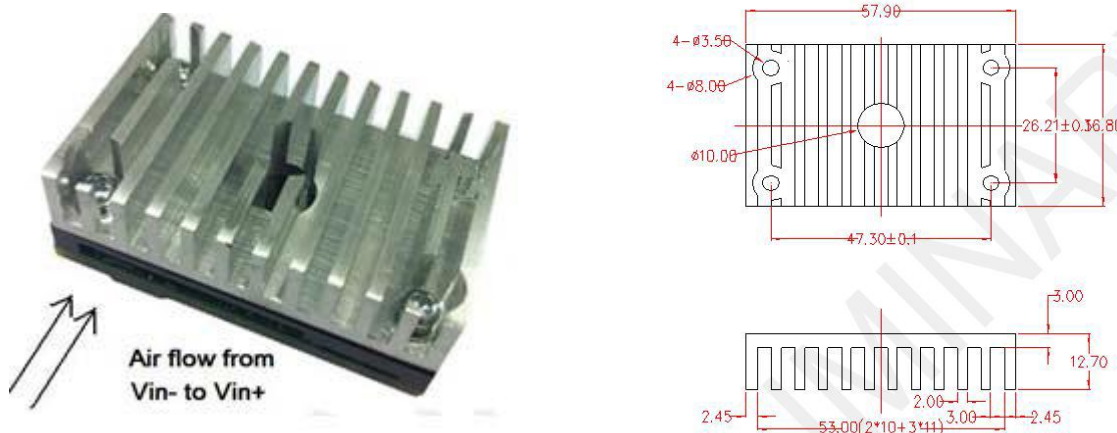

Figure 25 Typical test condition with heat sink

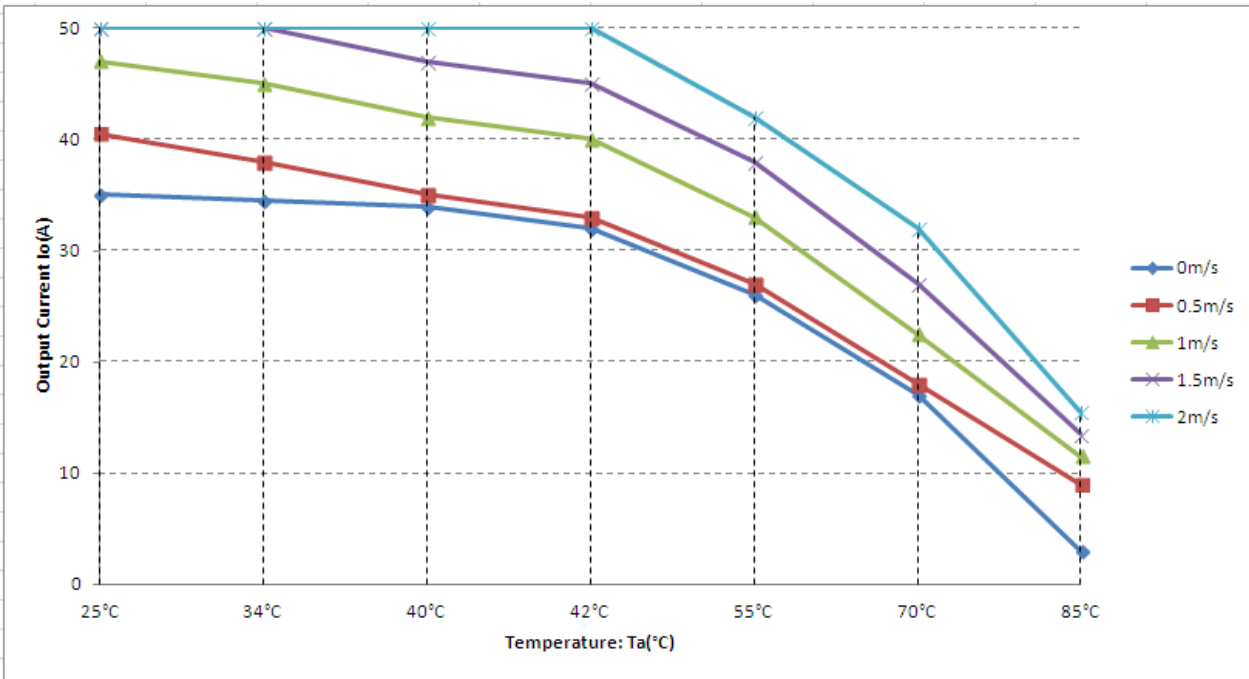

Figure 26 Thermal image, 48Vin, 12Vo, full load, room temperature

Qualification Testing

Parameter	Unit (pcs)	Test condition
Halt test	4-5	$T_{a,min} - 20\text{ }^{\circ}\text{C}$ to $T_{a,max} + 15\text{ }^{\circ}\text{C}$, $5\text{ }^{\circ}\text{C}$ step, $V_{in} = \text{min to max}$, $0 \sim 100\%$ load
Vibration	3	Frequency range: $5\text{Hz} \sim 20\text{Hz}$, $20\text{Hz} \sim 200\text{Hz}$, A.S.D: $1.0\text{m}^2/\text{s}^3$, -3db/oct , axes of vibration: X/Y/Z. Time: 30min/axes
Mechanical Shock	3	30g , 6ms , 3axes , 6directions , 3time/direction
Thermal Shock	3	$-40\text{ }^{\circ}\text{C}$ to $125\text{ }^{\circ}\text{C}$, unit temperature 20 cycles
Thermal Cycling	3	$-40\text{ }^{\circ}\text{C}$ to $85\text{ }^{\circ}\text{C}$, temperature change rate: $1\text{ }^{\circ}\text{C/min}$, cycles: 2cycles
Humidity	3	$40\text{ }^{\circ}\text{C}$, $95\%\text{RH}$, 48h
Solder Ability	15	IPC J-STD-002C-2007

Application Notes

Typical Application

Below is the typical application of the ADQ600-48S12 power supply.

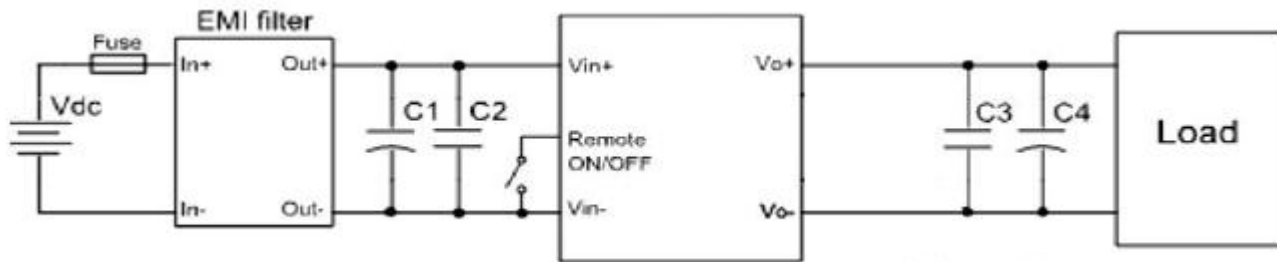

Figure 27 Typical application

C1: 220uF/100V electrolytic capacitor, P/N: UPM2A221MHD (Nichicon) or equivalent caps

C2, C3: 1uF/100V X7R ceramic capacitor, P/N: C3225X7R2A105KT0L0U (TDK) or equivalent caps

C4: 470uF/25V electrolytic capacitor, P/N: UPM1E471MED(Nichicon) or equivalent caps

Fuse: External fast blow fuse with a rating of 30A/250Vac. The recommended fuse model is 0314030.P from Karwin Tech limited.

Remote ON/OFF

Either Positive or Negative remote ON/OFF logic is available in ADQ600-48S12. The logic is CMOS and TTL compatible. The internal Remote ON/OFF is shown in figure 28.

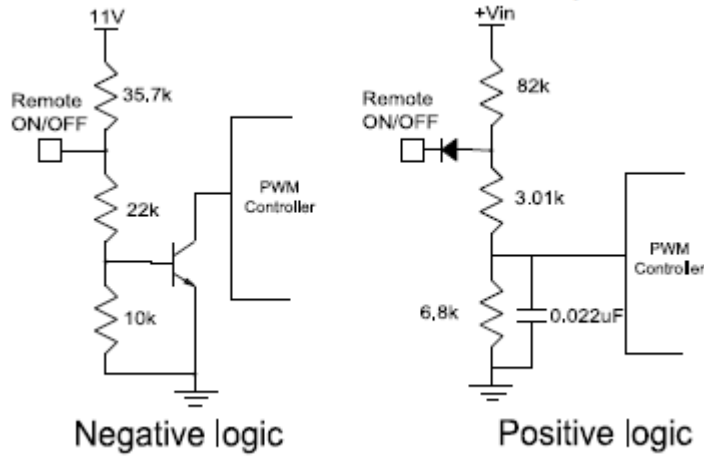

Figure 28 Internal Remote ON/OFF circuit

Parallel and Droop Current Sharing

The modules are capable of operating in parallel, and realizing current sharing by droop current sharing method. There is about 400mV output voltage droop from 0A to full output Load, and there is no current sharing pin. By connecting the Vin pin and the Vo pin of the parallel module together, the current sharing can be realized automatically.

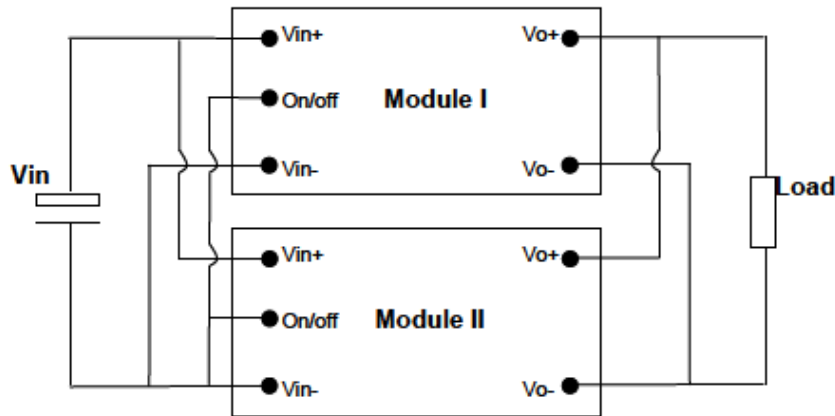

Figure 29 Parallel and droop current sharing configuration for no redundancy requirement system

If system has no redundancy requirement, the module can be parallel directly for higher power without adding external oring-fet; whereas, If the redundancy function is required, the external oring-fet should be added.

For a normal parallel operation the following precautions must be observed:

1. The current sharing accuracy equation is:

$$X\% = \left| I_o - \left(I_{total} / N \right) \right| / I_{rated}$$

Where,

I_o is the output current of per module;

I_{total} is the total load current;

N is parallel module numbers;

I_{rated} is the rated full load current of per module.

2. To ensure a better steady current sharing accuracy, below design guideline should be followed:

a) The inputs of the converters must be connected to the same voltage source; and the PCB trace resistance from Input voltage source to V_{in+} and V_{in-} of each converter should be equalized as much as possible.

b) The PCB trace resistance from each converter's output to the load should be equalized as much as possible.

c) For accurate current sharing accuracy test, the module should be soldered in order to avoid the unbalance of the touch resistance between the modules to the test board.

3. To ensure the parallel module can start up monotonically without triggering the OCP circuit, below design guideline should be followed:

a) Before all the parallel module finished start up, the total load current should be lower than the rated

b) The ON/OFF pin of the converters should be connected together to keep the parallel modules start up at the same time.

c) The under voltage lockout point will slightly vary from unit to unit. The dv/dt of the rising edge of the input source voltage must be greater than 1V/ms to ensure that the parallel module start up at the same time.

Input Ripple & Output Ripple & Noise Test Configuration

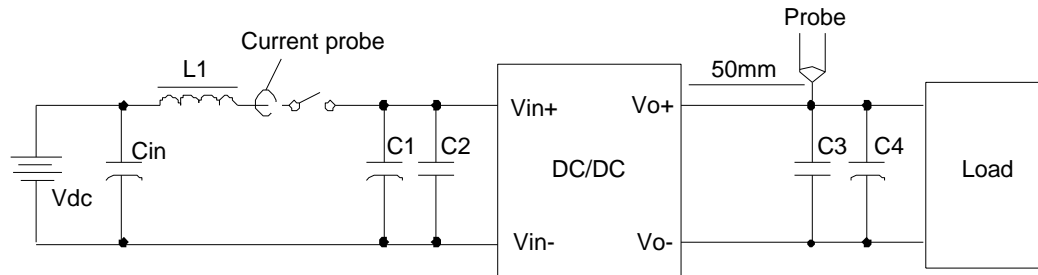

Figure 30 Input ripple & output ripple & noise test configuration

Vdc: DC power supply

L1: 12uH

Cin: 220uF/100V typical

C1 ~ C4: See Figure 27

Note - Using a coaxial cable with series 50ohm resistor and 0.68uF ceramic capacitor or a ground ring of probe to test output ripple & noise is recommended.

EMC Test Conditions

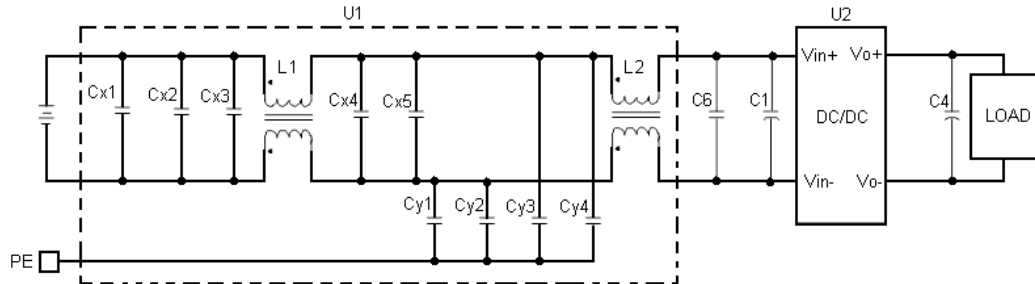

Figure 31 EMC test conditions

U1: Input EMC filter

U2: Module to test, ADQ600-48S12

CX1, CX2, 2*CX3, CX4, 2*CX5 : 1000nF/100V/X7R capacitor

(Cy1, Cy2, Cy3, Cy4)*2: 0.22μF/630V/X7R, Y capacitor

L1, L2: 473μH, common mode inductor

C6: 100nF/100V/X7R capacitor

C1, C4: See Figure 27

Soldering

The product is intended for standard manual, reflow or wave soldering.

When wave soldering is used, the temperature on pins is specified to maximum 255 °C for maximum 7s.

When manual soldering is used, the iron temperature should be maintained at 300 °C ~ 380 °C and applied to the converter pins for less than 10s. Longer exposure can cause internal damage to the converter.

Cleaning of solder joint can be performed with cleaning solvent IPA or simulative.

Hazardous Substances Announcement (RoHS of China)

Parts	Hazardous Substances					
	Pb	Hg	Cd	Cr ⁶⁺	PBB	PBDE
ADQ600-48S12-6L	x	x	x	x	x	x
ADQ600-48S12B-6L	x	x	x	x	x	x

x: Means the content of the hazardous substances in all the average quality materials of the part is within the limits specified in SJ/T-11363-2006

√: Means the content of the hazardous substances in at least one of the average quality materials of the part is outside the limits specified in SJ/T11363-2006

Artesyn Embedded Technologies has been committed to the design and manufacturing of environment-friendly products. It will reduce and eventually eliminate the hazardous substances in the products through unremitting efforts in research. However, limited by the current technical level, the following parts still contain hazardous substances due to the lack of reliable substitute or mature solution:

1. Solders (including high-temperature solder in parts) contain plumbum.
2. Glass of electric parts contains plumbum.
3. Copper alloy of pins contains plumbum

WORLDWIDE OFFICES

Americas

2900 S.Diablo Way
Tempe, AZ 85282
USA
+1 888 412 7832

Europe (UK)

Waterfront Business Park
Merry Hill, Dudley
West Midlands, DY5 1LX
United Kingdom
+44 (0) 1384 842 211

Asia (HK)

14/F, Lu Plaza
2 Wing Yip Street
Kwun Tong, Kowloon
Hong Kong
+852 2176 3333



www.artesyn.com

While every precaution has been taken to ensure accuracy and completeness in this literature, Artesyn Embedded Technologies assumes no responsibility, and disclaims all liability for damages resulting from use of this information or for any errors or omissions. Artesyn Embedded Technologies, Artesyn and the Artesyn Embedded Technologies logo are trademarks and service marks of Artesyn Technologies, Inc. All other names and logos referred to are trade names, trademarks, or registered trademarks of their respective owners.
© 2014 All rights reserved.

For more information: www.artesyn.com/power
For support: productsupport.ep@artesyn.com