

Chip tantalum capacitors with (Fail-safe open structure type)

TCFG series D Case

●Features

- 1) Safety design by open function built - in.
- 2) Wide capacitance range
- 3) Screening by thermal shock.

●Dimensions (Unit : mm)

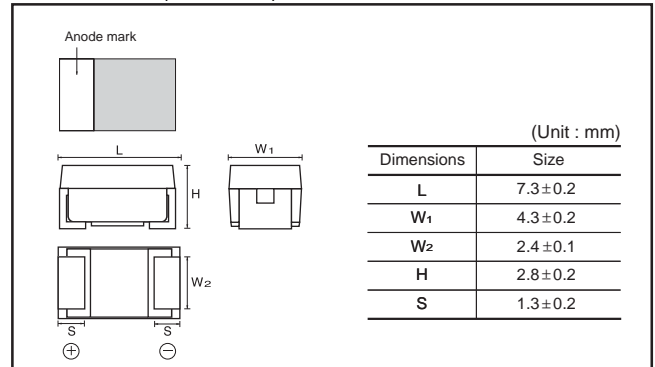

●Part No. Explanation

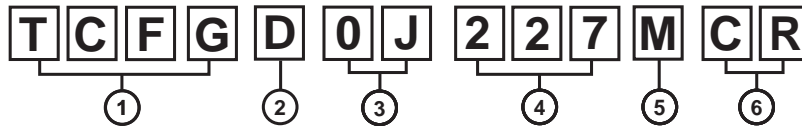

① Series name
TCFG

② Case code
D

③ Rated Voltage

Rated voltage (V)	4	6.3	10	16	20	25	35
CODE	0G	0J	1A	1C	1D	1E	1V

④ Capacitance

Nominal capacitance in pF. 3 digits : 2 significant figure representing the number of 0's.

⑤ Capacitance tolerance

M : ±20%

⑥ Taping

C : Reel width (12mm)
R : Positive electrode on the side opposite to sprocket hole

●Capacitance range

(μF)	Rated voltage (V.DC)						
	4	6.3	10	16	20	25	35
22 (226)							D
33 (336)							
47 (476)						D	
68 (686)					D *		
100 (107)				D			
150 (157)			D				
220 (227)		D					
330 (337)	D *						

Remark) Case size codes (D) in the above shown each size products line-up.

* : Under development

●Marking

The indication listed below should be given on the surface of a capacitor.

- ① Polarity : The polarity should be shown by □ bar. (on the anode side)
- ② Rated DC voltage
- ③ Nominal capacitance

[D Case] note 1) Visual typical example (1) capacitance code (2) voltage code

(1) 220μF

(2) 6.3V

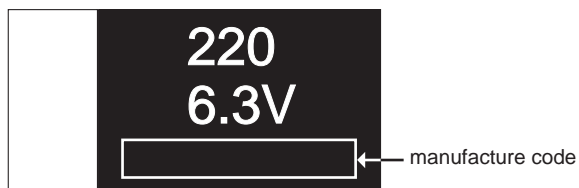

note 2) voltage code and capacitance code are variable with parts number

●Characteristics

Item		Performance	Test conditions (based on JIS C5101-1 and JIS C5101-3)															
Operating Temperature		-55 °C to +125 °C	Voltage reduction when temperature exceeds +85°C															
Maximum operating temperature with no voltage derating		+85 °C																
Rated Voltage (V.DC)		4 6.3 10 16 20 25 35	at 85°C															
Category Voltage (V.DC)		2.5 4 6.3 10 13 16 22	at 125°C															
Surge Voltage		5.0 8 13 20 26 32 44	at 85°C															
DC leakage current		0.5μA or 0.01CV whichever is greater (Shown in "Standard list")	As per 4.9 JIS C 5101-1 As per 4.5.1 JIS C 5101-3 Voltage : Rated voltage for 1 min															
Capacitance tolerance		Shall be satisfied allowance range. ±20%	As per 4.7 JIS C 5101-1 As per 4.5.2 JIS C 5101-3 Measuring frequency : 120±12Hz Measuring voltage : 0.5Vrms, +1.5 to 2V.DC Measuring circuit : DC Equivalent series circuit															
Tangent of loss angle (Df, tanδ)		Shall be satisfied the voltage on "Standard list"	As per 4.8 JIS C 5101-1 As per 4.5.3 JIS C 5101-3 Measuring frequency : 120±12Hz Measuring voltage : 0.5Vrms, +1.5 to 2V.DC Measuring circuit : DC Equivalent series circuit															
Impedance		Shall be satisfied the voltage on "Standard list"	As per 4.10 JIS C 5101-1 As per 4.5.4 JIS C 5101-3 Measuring frequency : 100±10kHz Measuring voltage : 0.5Vrms or less Measuring circuit : DC Equivalent series circuit															
Resistance to soldering heat	Appearance	There should be no significant abnormality. The indications should be clear.	As per 4.14 JIS C 5101-1 As per 4.6 JIS C 5101-3 Dip in the solder bath Solder temp : 260±10°C Duration : 5±0.5s Repetition : 1 After the specimens, leave it at room temperature for over 24h and then measure the sample.															
	L.C	TCFGD1E476 □ : Less than 150% of initial limit Others : Less than initial limit																
	ΔC / C	Within ±12% of initial value																
	tanδ	Less than 150% of initial limit																
Fail-Safe open unit actuation		Within 330°C – 20s	Dip in the solder bath Solder temp : 330±5°C															
Temperature cycle	Appearance	There should be no significant abnormality.	As per 4.16 JIS C 5101-1 As per 4.10 JIS C 5101-3 Repetition : 5 cycles (1 cycle : steps 1 to 4) without discontinuation. <table border="1" data-bbox="868 1373 1195 1532"> <thead> <tr> <th>Step</th> <th>Temp.</th> <th>Time</th> </tr> </thead> <tbody> <tr> <td>1</td> <td>-55±3°C</td> <td>30±3min</td> </tr> <tr> <td>2</td> <td>Room temp.</td> <td>3min. or less</td> </tr> <tr> <td>3</td> <td>125±2°C</td> <td>30±3min</td> </tr> <tr> <td>4</td> <td>Room temp.</td> <td>3min. or less</td> </tr> </tbody> </table> After the specimens, leave it at room temperature for over 24h and then measure the sample.	Step	Temp.	Time	1	-55±3°C	30±3min	2	Room temp.	3min. or less	3	125±2°C	30±3min	4	Room temp.	3min. or less
	Step	Temp.		Time														
	1	-55±3°C		30±3min														
	2	Room temp.		3min. or less														
3	125±2°C	30±3min																
4	Room temp.	3min. or less																
L.C	TCFGD1E476 □ : Less than 150% of initial limit Others : Less than initial limit																	
ΔC / C	Within ±20% of initial value																	
tanδ	Less than 150% of initial limit																	
Moisture resistance	Appearance	There should be no significant abnormality. The indications should be clear.	As per 4.22 JIS C 5101-1 As per 4.12 JIS C 5101-3 After leaving the sample under such atmospheric condition that the temperature and humidity are 60±2°C and 90 to 95%RH, respectively, for 500±12h level it at room temperature for over 24h and then measure the sample.															
	L.C	TCFGD1E476 □ : Less than 150% of initial limit Others : Less than initial limit																
	ΔC / C	Within ±20% of initial value																
	tanδ	Less than 150% of initial limit																

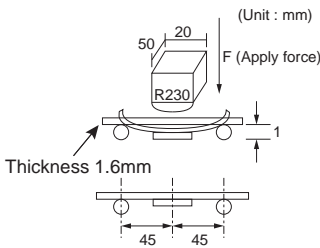
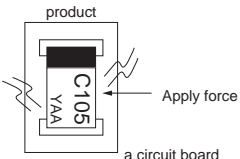
Item		Performance	Test conditions (based on JIS C5101-1 and JIS C5101-3)
Temperature Stability	Temp.	-55°C	As per 4.29 JIS C 5101-1 As per 4.13 JIS C 5101-3
	ΔC / C	Within 0/-20%of initial value	
	tanδ	Shall be satisfied the voltage on "Standard list"	
	L.C	-	
	Temp.	+85°C	
	ΔC / C	Within +12/0%of initial value	
	tanδ	Shall be satisfied the voltage on "Standard list"	
	L.C	Less than 1000% of initial limit	
	Temp.	+125°C	
	ΔC / C	Within +20/0%of initial value	
	tanδ	Shall be satisfied the voltage on "Standard list"	
L.C	Less than 1250% of initial limit		
Surge Voltage	Appearance	There should be no significant abnormality.	As per 4.26 JIS C 5101-1 As per 4.14 JIS C 5101-3 Apply the specified surge voltage via the serial resistance of 1kΩ every 5±0.5min. for 30±5 s. each time in the atmospheric condition of 85±2°C. Repeat this procedure 1,000 times. After the specimens, leave it at room temperature for over 24h and then measure the sample.
	L.C	TCFGD1E476 □ : Less than 150% of initial limit Others : Less than initial limit	
	ΔC / C	Within ±10%of initial value	
	tanδ	Less than 150% of initial limit	
Loading at High temperature	Appearance	There should be no significant abnormality.	As per 4.23 JIS C 5101-1 As per 4.15 JIS C 5101-3 After applying the rated voltage for 2000+72/0h without discontinuation via the serial resistance of 3Ω or less at a temperature of 85±2°C, leave the sample at room temperature/humidity for over 24h and measure the value.
	L.C	TCFGD1E476 □ : Less than 150% of initial limit Others : Less than 125% of initial limit	
	ΔC / C	Within ±10%of initial value	
	tanδ	Less than 150% of initial limit	
Terminal Strength	Capacitance	The measured value should be stable.	As per 4.35 JIS C 5101-1 As per 4.9 JIS C 5101-3 A force is applied to the terminal until it bends to 1mm and by a prescribed tool maintain the condition for 5s. (See the figure below.) <div style="text-align: center;">  <p>(Unit : mm)</p> </div>
	Appearance	There should be no significant abnormality.	
Adhesiveness	The terminal should not come off.	As per 4.34 JIS C 5101-1 As per 4.8 JIS C 5101-3 Apply force of 5N in the two directions shown in the figure below for 10±1s after mounting the terminal on a circuit board. <div style="text-align: center;">  </div>	

Item	Performance	Test conditions (based on JIS C5101-1 and JIS C5101-3)
Dimensions	Be based on "External dimensions"	Measure using a caliper of JIS B 7505 Class 2 or higher grade.
Resistance to solvents	The indication should be clear.	As per 4.32 JIS C 5101-1 As per 4.18 JIS C 5101-3 Dip in the isopropyl alcohol for 30±5s, at room temperature.
Solderability	3/4 or more surface area of the solder coated terminal dipped in the soldering bath should be covered with the new solder.	As per 4.15.2 JIS C 5101-1 As per 4.7 JIS C 5101-3 Dip speed = 25±2.5mm/s Pre-treatment (accelerated aging) : Leave the sample on the boiling distilled water for 1h. Solder temp. : 245±5°C Duration : 3±0.5s Solder : M705 Flux : Rosin 25%, IPA 75%
Vibration	Capacitance	As per 4.17 JIS C 5101-1 Frequency : 10 to 55 to 10Hz/min. Amplitude : 1.5mm Time : 2h each in X and Y directions Mounting : The terminal is soldered on a print circuit board.
	Appearance	

●Table 1 standard list, TCFG series D Case

Part No.	Rated Voltage @85°C (V)	Derated Voltage @125°C (V)	Surge Voltage @85°C (V)	Capacitance 120Hz (μF)	Tolerance (%)	Leakage current 25°C 1VV.60s (mA)	DF120Hz (%)			Impedance 100kHz (Ω)	Case code
							-55°C	25°C 85°C	125°C		
*TCFG D 0G 337 MCR	4	2.5	5	330	±20	13.2	32	14	20	0.7	D
TCFG D 0J 227 MCR	6.3	4	8	220	±20	13.8	30	12	16	0.7	D
TCFG D 1A 157 MCR	10	6.3	13	150	±20	15.0	14	10	12	0.7	D
TCFG D 1C 107 MCR	16	10	20	100	±20	16	14	10	12	0.7	D
TCFG D 1E 476 MCR	25	16	32	47	±20	11.8	14	10	12	0.7	D
TCFG D 1V 226 MCR	35	22	44	22	±20	7.7	14	10	12	0.8	D

* = Under development

●Packaging specifications

Taping (Unit : mm)

Case code	A±0.1	B±0.1	t ₁ ±0.05	t ₂ ±0.1
D	4.9	7.7	0.3	3.3

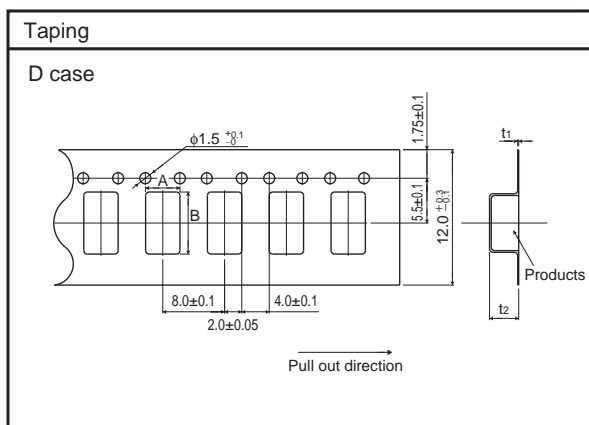

●Packaging style

Case size	Packaging	Packaging style		Symbol	Basic ordering unit
D Case	Taping	Plastic taping	φ180mm reel	CR	500

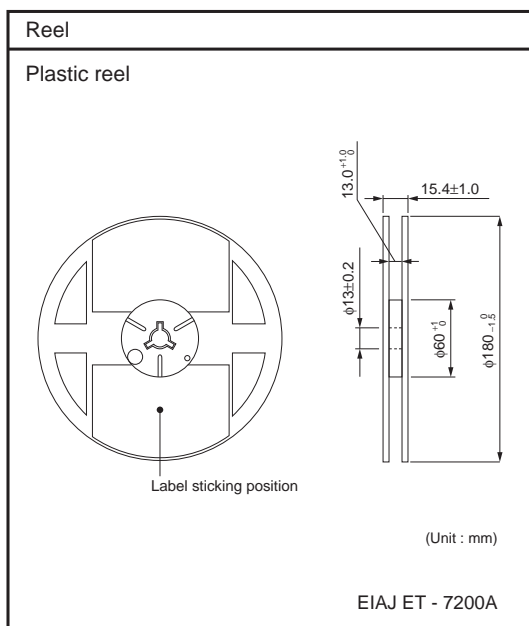

Notes

No copying or reproduction of this document, in part or in whole, is permitted without the consent of ROHM Co.,Ltd.

The content specified herein is subject to change for improvement without notice.

The content specified herein is for the purpose of introducing ROHM's products (hereinafter "Products"). If you wish to use any such Product, please be sure to refer to the specifications, which can be obtained from ROHM upon request.

Examples of application circuits, circuit constants and any other information contained herein illustrate the standard usage and operations of the Products. The peripheral conditions must be taken into account when designing circuits for mass production.

Great care was taken in ensuring the accuracy of the information specified in this document. However, should you incur any damage arising from any inaccuracy or misprint of such information, ROHM shall bear no responsibility for such damage.

The technical information specified herein is intended only to show the typical functions of and examples of application circuits for the Products. ROHM does not grant you, explicitly or implicitly, any license to use or exercise intellectual property or other rights held by ROHM and other parties. ROHM shall bear no responsibility whatsoever for any dispute arising from the use of such technical information.

The Products specified in this document are intended to be used with general-use electronic equipment or devices (such as audio visual equipment, office-automation equipment, communication devices, electronic appliances and amusement devices).

The Products specified in this document are not designed to be radiation tolerant.

While ROHM always makes efforts to enhance the quality and reliability of its Products, a Product may fail or malfunction for a variety of reasons.

Please be sure to implement in your equipment using the Products safety measures to guard against the possibility of physical injury, fire or any other damage caused in the event of the failure of any Product, such as derating, redundancy, fire control and fail-safe designs. ROHM shall bear no responsibility whatsoever for your use of any Product outside of the prescribed scope or not in accordance with the instruction manual.

The Products are not designed or manufactured to be used with any equipment, device or system which requires an extremely high level of reliability the failure or malfunction of which may result in a direct threat to human life or create a risk of human injury (such as a medical instrument, transportation equipment, aerospace machinery, nuclear-reactor controller, fuel-controller or other safety device). ROHM shall bear no responsibility in any way for use of any of the Products for the above special purposes. If a Product is intended to be used for any such special purpose, please contact a ROHM sales representative before purchasing.

If you intend to export or ship overseas any Product or technology specified herein that may be controlled under the Foreign Exchange and the Foreign Trade Law, you will be required to obtain a license or permit under the Law.



Thank you for your accessing to ROHM product informations.
More detail product informations and catalogs are available, please contact us.

ROHM Customer Support System

<http://www.rohm.com/contact/>