

- Round caps
- 2400 options in the series
- Ø5.2 mm; Ø7.8 mm; Ø11.6 mm
- h =10.4-22.5 mm
- Material: polyamide
- Temp. Range:-40/+160°C

All dimensions in mm

Tolerances +/-0.2mm

## DIMENSIONS

### SMD+Round ø5.2

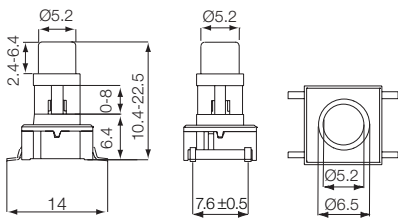

### TH+Round ø7.8

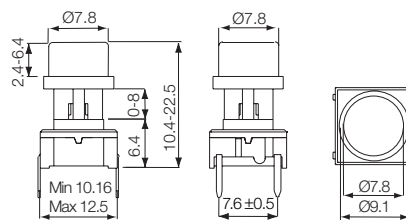

### SMD+Round ø11.6

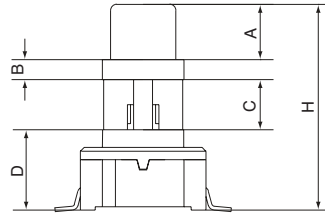
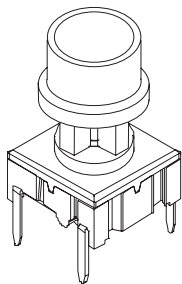
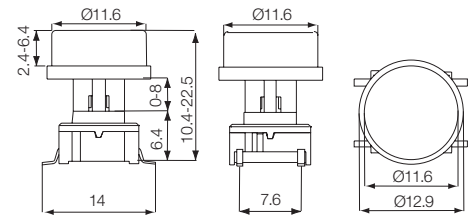

### The Concept

H= Overall heights from 10.4-22.5  
 A= Variable height from 2.4 to 6.4  
 H has to exceed A with min. 8.0  
 B= Fixed recess 1.6  
 D= Fixed switch 6.4  
 C= variable from 0-8.1  
 C=H-A-B-D  
 All measurements in mm

## HOW TO ORDER

Switch	Shape and size	Colour code	Overall height H	Height above recess A	Tape*
<b>3 E S H</b>	<input type="checkbox"/>	<input type="checkbox"/>	<input type="checkbox"/>	<input type="checkbox"/>	<input type="checkbox"/>
<b>3 E T H</b>	<b>A</b> 5.2 Round <b>E</b> 7.8 Round <b>K</b> 11.6 Round	<b>60</b> blue <b>63</b> grey <b>64</b> yellow <b>68</b> red <b>69</b> black	<b>A</b> 10.4 <b>B</b> 11.0 <b>C</b> 12.0 <b>D</b> 12.5 <b>E</b> 13.0 <b>F</b> 14.0 <b>G</b> 15.0 <b>H</b> 16.0 <b>J</b> 19.0 <b>K</b> 22.5	<b>A</b> 2.4 <b>B</b> 3.0 <b>C</b> 3.5 <b>D</b> 4.0 <b>E</b> 4.5 <b>F</b> 5.0 <b>G</b> 5.6 <b>H</b> 6.4	<b>R</b>

Ordering example:

Examples switch and cap: 3ETHE64CC = Switch 3ETH, 7.8 round cap, yellow, overall height 12.0, height above recess 3.5, (height under recess 0.5).

Example caap alone: 3E-E63FF = Cap, 7.8 round, grey, overall height with switch 14.0, height above recess 5.0, (height under recess 1.0).

Min. order is 2.000 pcs. per shape, size and heights for parts mentioned above.

For heights not mentioned in the list a start-up fee will apply.

\*Only overall height up to 12.5mm can be supplied on tape.

Please see colour codes, updates of products and changes of specifications on [www.apem.com](http://www.apem.com)

- Square caps
- 2400 options in the series
- 5.2 mm x 5.2 mm; 7.8 mm x 7.8 mm; 11.6 mm x 11.6 mm
- h = 10.4-22.5 mm
- Material: polyamide
- Temp. Range: -40/+160°C

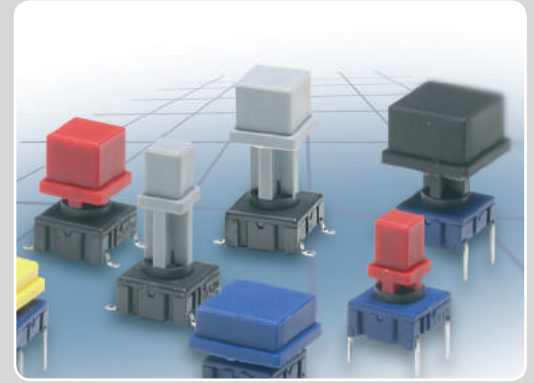

All dimensions in mm

Tolerances +/-0.2mm

## DIMENSIONS

### TH+Square 5.2

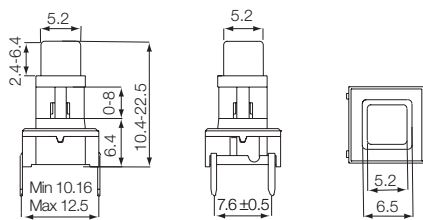

### SMD+Square 7.8

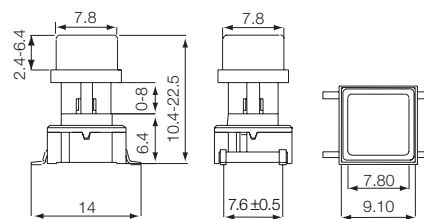

### TH+Square 11.6

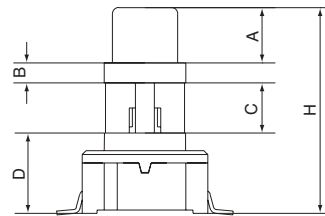
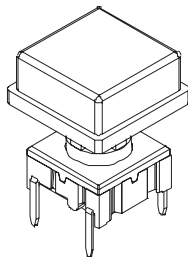
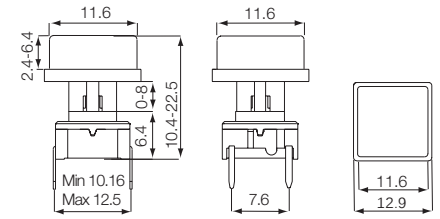

### The Concept

H= Overall heights from 10.4-22.5  
 A= Variable height from 2.4 to 6.4  
 H has to exceed A with min. 8.0  
 B= Fixed recess 1.6  
 D= Fixed switch 6.4  
 C= variable from 0-8.1  
 C=H-A-B-D  
 All measurements in mm

## HOW TO ORDER

Switch	Shape and size	Colour code	Overall height H	Height above recess A	Tape*
<b>3 E S H</b>	<input type="checkbox"/>	<input type="checkbox"/>	<input type="checkbox"/>	<input type="checkbox"/>	<input type="checkbox"/>
<b>3 E T H</b>	<b>B</b> 5.2 Square	<b>60</b> blue	<b>A</b> 10.4	<b>A</b> 2.4	<b>R</b>
	<b>F</b> 7.8 Square	<b>63</b> grey	<b>B</b> 11.0	<b>B</b> 3.0	
	<b>L</b> 11.6 Square	<b>64</b> yellow	<b>C</b> 12.0	<b>C</b> 3.5	
		<b>68</b> red	<b>D</b> 12.5	<b>D</b> 4.0	
		<b>69</b> black	<b>E</b> 13.0	<b>E</b> 4.5	
			<b>F</b> 14.0	<b>F</b> 5.0	
			<b>G</b> 15.0	<b>G</b> 5.6	
			<b>H</b> 16.0	<b>H</b> 6.4	
			<b>J</b> 19.0		
			<b>K</b> 22.5		

Ordering example:

Examples switch and cap: 3ESH60AA = Switch 3ESH, 5.2 square cap, blue, overall height 10.4, height above recess 2.4, (height under recess 0).

Example caap alone: 3E-E63FF = Cap, 7.8 square, grey, overall height with switch 14.0, height above recess 5.0, (height under recess 1.0).

Min. order is 2.000 pcs. per shape, size and heights for parts mentioned above.

For heights not mentioned in the list a start-up fee will apply.

\*Only overall height up to 12.5mm can be supplied on tape.

Please see colour codes, updates of products and changes of specifications on [www.apem.com](http://www.apem.com)



- Through-hole (TH) or surface mount (SMD)
- 50mA/24VDC
- Single pole/momentary
- 10,000,000 operations lifetime
- Temperature range:
  - High temp: -40/+160C
- IP 67 sealing
- Actuation force: 3.5N
- Most caps in the catalogue have a version for mounting on 3F switch as well. Contact MEC for further information.

All dimensions in mm

Tolerances +/-0.2mm

### 3C (TH, SMD & RAS)

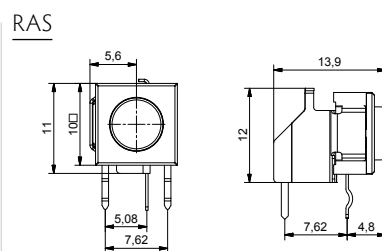
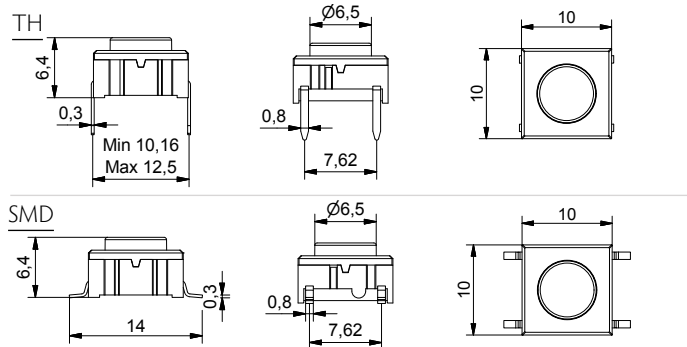

### PCB LAYOUT

#### Through-hole

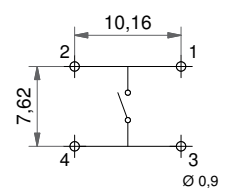

#### Surface mount

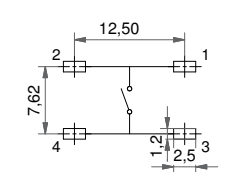

### 3E (TH, SMD & RAS)

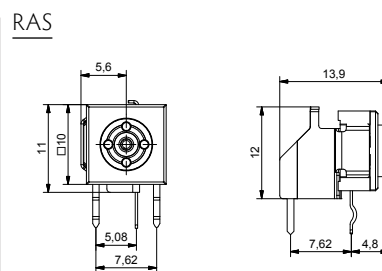
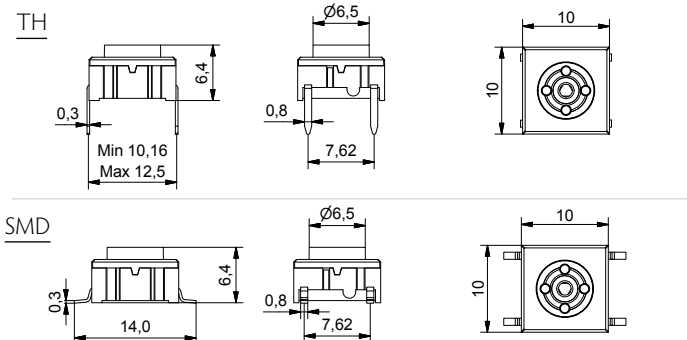

#### Through-hole RAS

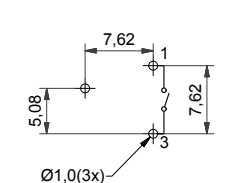

### 3F (TH, SMD & RAS w/LED)

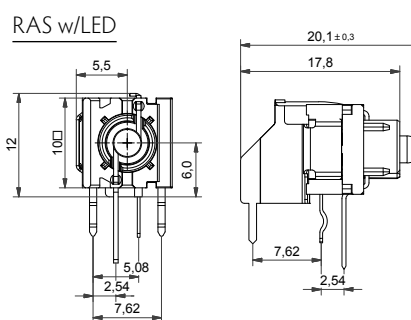
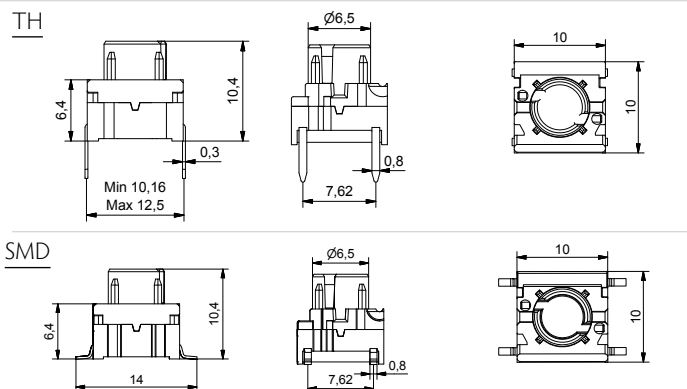

#### Through-hole illuminated RAS

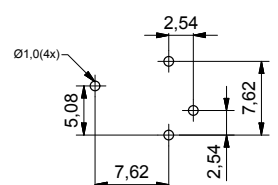

### HOW TO ORDER

Switch	Mounting	Temperature range	LED (onyl for 3F)	Right angle support
<input type="checkbox"/>	<input type="checkbox"/>	<b>H 9</b>	<input type="checkbox"/>	<input type="checkbox"/>
<b>3C</b>	<b>T</b> through-hole	<b>H9</b> high temp.	<b>00</b> blue <b>60</b> white <b>8020</b> red/ green	<b>RAS</b> optional
<b>3E</b>	<b>S</b> surface mount		<b>20</b> green <b>80</b> red	3FTH9RAS with LED can be used with the 3 series keycaps: 1D, 1E, 1F, 1K, 1N, 1Q, 1R, 1S, 1T, 1U, 1V, 1WA, 1WD, 1WP, 1X. Ask further information on caps from MEC.
<b>3F</b>			<b>40</b> yellow <b>2040</b> green/ yellow <b>8040</b> red/ yellow	

## RoHS Compatible

		HIGH TEMPERATURE VERSIONS	
		SILVER	GOLD
<b>ELECTRICAL SPECIFICATIONS</b>			
Contact resistance	<30m Ω - typ. 10m Ω		
Insulation resistance	>10M Ω		
Recommended load	0.5-50mA 24VDC	0.5μ-50mA 24VDC	
Contact bounce	<2mS - typically 0.5mS		
<b>MECHANICAL SPECIFICATIONS</b>			
Standard actuation force (switch)	3.5N typ		
Max. Actuation force without cap	100N for 10 sec		
Key travel (switch)	1 mm		
Life time (switch)	>10,000,000		
Temperature Range			
Working temperature	Min -40°C Max +160°C		
Storage temperature	Min -40°C Max +160°C		
Soldering IEC 68-2-20	Infrared, vapour phase, wave - max 240°C for max 40 sec or max 260°C for max 30 sec. Soldering iron - max 350°C for max 3 sec. Flux tight.		
<b>ENVIRONMENTAL ENDURANCE IEC 68-2-3</b>			
Temperature	+40°C		
Humidity	93% RH		
Duration	56 Days		
<b>TEMPERATURE CYCLING IEC 68-2-14</b>			
Temperature limit	Min -55°C - Max +85°C		
Number of cycles	200		
Exposure time at each temperature	10 min		
Recovery time before measurements	16 hrs		
Sealing IEC 529	IP-67		
Cleaning	Standard methods - see usage guidelines		
<b>MATERIAL SPECIFICATIONS - SWITCHES</b>			
Housing	PPS UL94V0		
Actuator	PPS UL94V0		
Sealing + spring	Silicone rubber		
Contact spring	Stainless steel	Stainless steel	
	+ 3μAg	+ 1μAu	
Fixed contacts	SnCu + 2μNI + 3μAg	SnCu + 2μNI + 1μAu	
Terminals	SnCu + 2μNI + 3μSn100		

## Caps – Material Specifications

MATERIAL	PARTS	TEMP. LIMIT	UL RATING
Polyamide	Actuators for varimec™	Max 160°C	UL94V2

# Usage guidelines

## How to get the best results with MEC Switches?

These guidelines are offered to users of MEC Switches as an aid to ensure successful and reliable switch operation.

### Temperature

Both unimec™ and multimec® switches are produced in low and high temperature versions. Please see the technical specifications for details on operating and storage temperatures and soldering guidelines to make sure you select the best switch for your application. When wave soldering is taking place, MEC strongly recommend that the temperature profile is analysed and compared with the temperature rating of the switch. In case of doubt always select the high temperature versions unimec™ 154XX, and multimec® 5XXH9XX. It is also important to monitor the accumulated heat build up from both the pre-heat zones and the solder zone.

Most standard accessories for both unimec™ and multimec® switches are made from ABS plastic with a maximum operating temperature of 65°C. It is strongly recommended that accessories are mounted after soldering of the switch. If this is not possible care must be taken not to overheat the accessories during the soldering process. The 1SS, 1GAS/1GCS and Varimec™ caps are, however, made of high temperature materials and will meet the same temperature specifications as the high temperature switches.

For accessories made from other plastic materials please see multimec® and unimec™ technical specifications.

LEDs have their own temperature specifications. When fitted in a high temperature switch the LED will determine the max. operating temperature, i.e. 5GTH93524 has an upper temperature limit of 85°C! This also applies with 3F switches.

### Mounting and Dismounting

If switches are to be mounted in rows it is essential that the recommendations regarding spacing are followed. PC board thickness should be 1.4±0.2 mm and terminal hole diameter should be 0.9mm.

All unimec™ and multimec® caps and bezels are easily snapped onto the switch modules and can be changed at a later time with the exception of the unimec 16.700 cap. The same applies to the 3E caps. Once these caps are installed they are not designed to be removed. To do so may cause damage to the switch and the PC board if not done very carefully. If the 16.300 or 16.700 cap must be removed from a unimec™ alternate action switch, make sure that the switch actuator is in the released, upper position before attempting to remove the cap. This will prevent possible damage to the internal latching pin.

Care must be taken when inserting the 3FT switch and LED assembly into the PC board. Do not press direct on the LED. This will force the LED down into the actuator and risks to cause the switch contacts to remain in the closed position. To correct the fault, the LED must be raised slightly and centered in the actuator to assure unrestricted movement of the actuator. A mounting tool is available for multimec® switches.

### Soldering and Cleaning unimec™

Most assembly and field problems experienced by users of unsealed switches are caused by the contamination of the contacts during soldering and cleaning.

Contact contamination may be recognised by an increase in contact resistance and possible intermittent operation of the switch, especially in low power applications. Care must be taken not to submerge the switch in cleaning agents or spray the switch during cleaning. The switch must be protected at all times to prevent contamination by flux or cleaning liquids.

For unimec™ alternate versions we recommend to leave the actuator in the released upper position during soldering. This makes the switch more resistant to overheating.

### Soldering and Cleaning multimec®

multimec® switches are fully sealed to IP67 specifications to prevent solder flux and aqueous based cleaning solutions from entering the switch and contaminating the contacts. The switches can be placed on the PC board with other components and wave soldered. multimec® offers a high level of sealing, however, with aqueous solvent solutions care must be taken to avoid the worst case situation with water jets, complete immersion into a liquid with a temperature below the board or surface tension reducing additives.

Recommended cleaning methods are demineralized water. Any surface tension reducing agents, such as soap, must not be used as they risk causing a potential leakage of the switch.

### Soldering - Through Hole Versions

Hand soldering: Max. 350°C for max. 3 sec., this applies for both low temperature and high temperature versions.

Wave soldering: heat built up in the switch during pre-heating and soldering must not exceed the maximum operating temperature of the switch. If, for some reason, a high pre-heating temperature is required, MEC recommend the high temperature switches. In any case peak temperature must not exceed 260°C, and soldering time is max 10 sec.

### Soldering - Surface Mount Versions

For all methods - infrared, convection and vapour phase. The upper limit 260°C/30 sec must be observed. The soldering temperature profile must have moderate temperature gradients.

### RoHS Compliance

As of 1 July 2006 MEC has completed the conversion to RoHS compliance. For more info please see our homepage [www.mec.dk](http://www.mec.dk)

### Temperature Limits:

Low temperature switch	115°C
High temperature switch	160°C
LEDs	85/100°C
Accessories	65/85/160°C

### Packaging

unimec™ and multimec® switches are packed in rigid tubes of 50 pieces each.

A box contains 1.000 pcs.

The surface mount versions of multimec® switches with a height up to 12.5mm can also be delivered on tape/reel. Each reel contains 250/500 pcs.