

4 x 45 W power amplifier with full I²C diagnostics, SSR and low voltage operation

Datasheet - production data

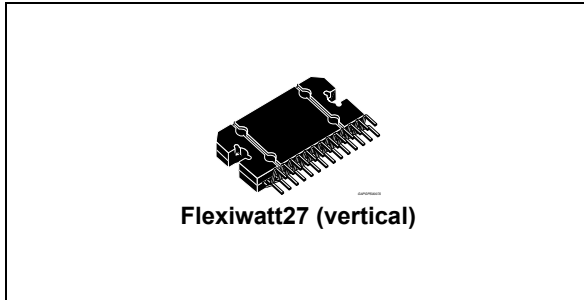

- Standby/mute pin
- Linear thermal shutdown with multiple thermal warning
- ESD protection
- Very robust against misconnections
- Improved SVR suppression during battery transients
- Capable to operate down to 6 V (e.g. "Start-stop")
- Enableable SSR (speaker safety routine)

Features

- Multipower BCD technology
- MOSFET output power stage
- DMOS power output
- High output power capability 4x25 W/4 Ω @ 14.4 V, 1 kHz, 10% THD, 4 x 45 W max power
- 2 Ω driving capability (64 W max power)
- Full I²C bus driving:
 - Standby
 - Independent front/rear soft play/mute
 - Selectable gain 30 dB /16 dB (for low noise line output function)
 - I²C bus digital diagnostics (including DC and AC load detection)
- Flexible fault detection through integrated diagnostic
- DC offset detection
- Four independent short circuit protection
- Clipping detector pin with selectable threshold (2 %/10 %)

Description

The TDA75612LV is a new quad bridge car radio amplifier, designed in BCD technology, in order to include a wide range of innovative features in a very compact and flexible device.

The TDA75612LV is equipped with the most complete diagnostics array that communicates the status of each speaker through the I²C bus.

TDA75612LV has been designed to be very robust against several kinds of misconnections.

The TDA75612LV is equipped with the SSR (speaker safety routine), a procedure able to check the offset at the speakers and automatically shut down the power amplifier in case of dangerous DC voltage.

It is moreover compliant to the most recent OEM specifications for low voltage operation (so called 'start-stop' battery profile during engine stop), helping car manufacturers to reduce the overall emissions and thus contributing to environment protection.

Table 1. Device summary

| Order code | Package | Packing |
|----------------|------------------------|---------|
| TDA75612LV-48X | Flexiwatt27 (vertical) | Tube |

Contents

- 1 Block diagram and application circuits 6**
- 2 Pins description 7**
- 3 Electrical specifications 9**
 - 3.1 Absolute maximum ratings 9
 - 3.2 Thermal data 9
 - 3.3 Electrical characteristics 10
- 4 Diagnostics functional description 14**
 - 4.1 Turn-on diagnostic 14
 - 4.2 Permanent diagnostics 16
 - 4.3 AC diagnostic 17
- 5 Output DC offset detection 19**
 - 5.1 Offset detection and mute at start-up, SSR (Speaker Safety Routine) .. 19
 - 5.2 Offset detection in normal operation 20
- 6 Multiple faults 21**
 - 6.1 Faults availability 21
- 7 Thermal protection 22**
 - 7.1 Fast muting 22
- 8 Battery transitions management 23**
 - 8.1 Low voltage operation (“start stop”) 23
 - 8.2 Advanced battery management 24
- 9 I²C bus 25**
 - 9.1 I²C programming/reading sequences 25
 - 9.2 Address selection and I²C disable 25
 - 9.3 I²C bus interface 25
 - 9.3.1 Data validity 25

| | | |
|-----------|-----------------------------------|-----------|
| 9.3.2 | Start and stop conditions | 25 |
| 9.3.3 | Byte format | 26 |
| 9.3.4 | Acknowledge | 26 |
| 10 | Software specifications | 27 |
| 11 | Examples of bytes sequence | 32 |
| 12 | Package information | 33 |
| 13 | Revision history | 34 |

List of tables

| | | |
|-----------|---|----|
| Table 1. | Device summary | 1 |
| Table 2. | Pins list description | 8 |
| Table 3. | Absolute maximum ratings | 9 |
| Table 4. | Thermal data | 9 |
| Table 5. | Electrical characteristics | 10 |
| Table 6. | Double fault table for turn on diagnostic | 21 |
| Table 7. | IB1 | 27 |
| Table 8. | IB2 | 28 |
| Table 9. | DB1 | 28 |
| Table 10. | DB2 | 29 |
| Table 11. | DB3 | 30 |
| Table 12. | DB4 | 31 |
| Table 13. | Document revision history | 34 |

List of figures

| | | |
|------------|--|----|
| Figure 1. | Block diagram | 6 |
| Figure 2. | Application circuit | 6 |
| Figure 3. | Pins connection diagram (top of view) | 7 |
| Figure 4. | ITU R-ARM frequency response, weighting filter for transient pop. | 13 |
| Figure 5. | Turn-on diagnostic: working principle | 14 |
| Figure 6. | SVR and output behavior (Case 1: without turn-on diagnostic) | 14 |
| Figure 7. | SVR and output pin behavior (Case 2: with turn-on diagnostic). | 15 |
| Figure 8. | Short circuit detection thresholds | 15 |
| Figure 9. | Load detection thresholds - high gain setting | 15 |
| Figure 10. | Load detection threshold - low gain setting | 15 |
| Figure 11. | Restart timing without diagnostic enable (permanent) | 16 |
| Figure 12. | Restart timing with diagnostic enable (permanent). | 16 |
| Figure 13. | Current detection high: load impedance $ Z $ vs. output peak voltage | 18 |
| Figure 14. | Current detection low: load impedance $ Z $ vs. output peak voltage | 18 |
| Figure 15. | Power on sequence with a detected offset lower than 2 V | 19 |
| Figure 16. | Power on sequence with a detected offset higher than 2 V | 20 |
| Figure 17. | Thermal foldback diagram | 22 |
| Figure 18. | Worst case battery cranking curve sample 1 | 23 |
| Figure 19. | Worst case battery cranking curve sample 2 | 23 |
| Figure 20. | Upwards fast battery transitions diagram | 24 |
| Figure 21. | Data validity on the I ² C bus | 26 |
| Figure 22. | Timing diagram on the I ² C bus | 26 |
| Figure 23. | Acknowledge on the I ² C bus | 26 |
| Figure 24. | Flexiwatt27 (vertical) mechanical data and package dimensions. | 33 |

1 Block diagram and application circuits

Figure 1. Block diagram

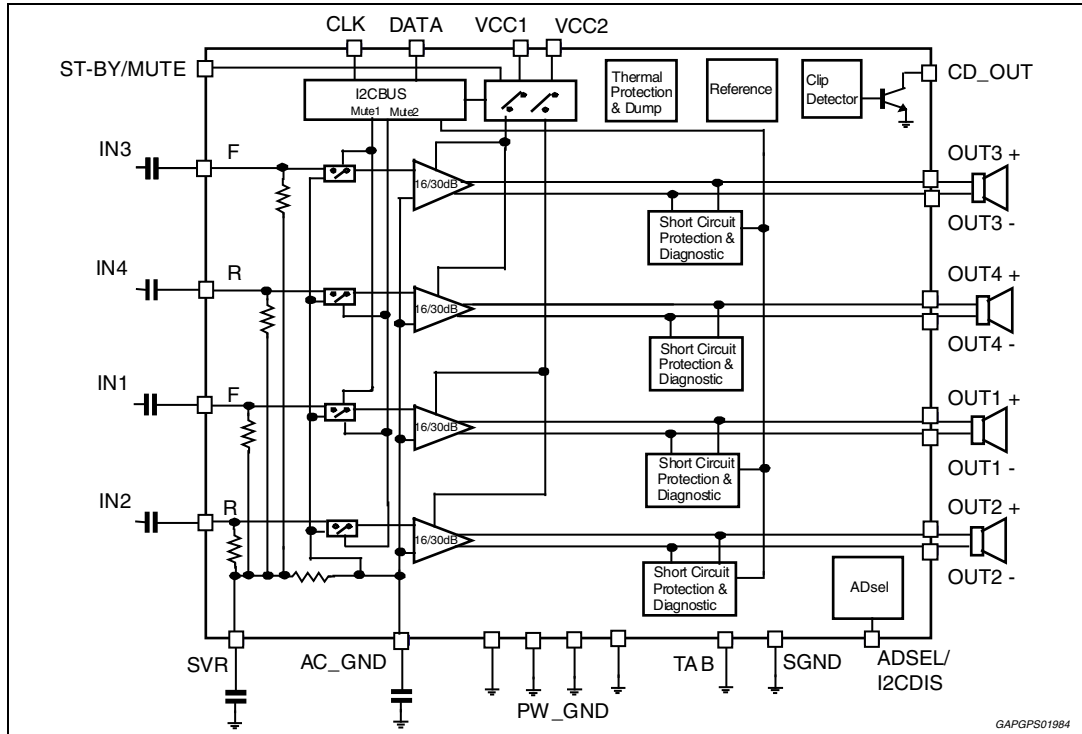
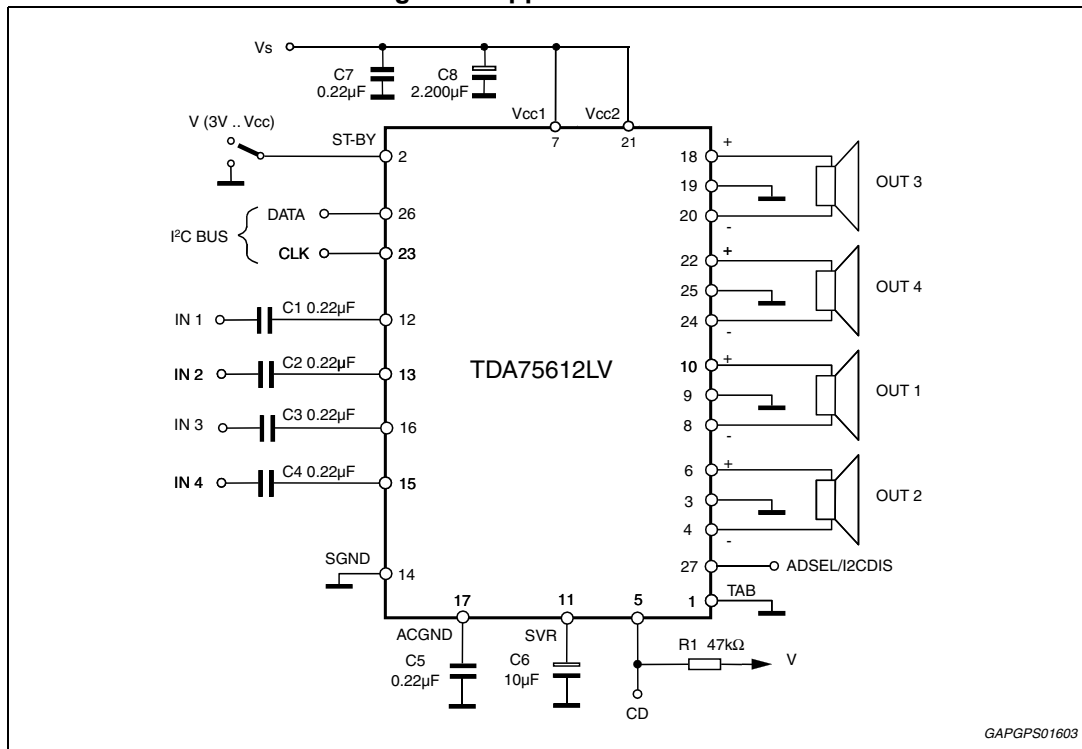

Figure 2. Application circuit



2 Pins description

For channel name reference: CH1 = LF, CH2 = LR, CH3 = RF and CH4 = RR.

Figure 3. Pins connection diagram (top of view)

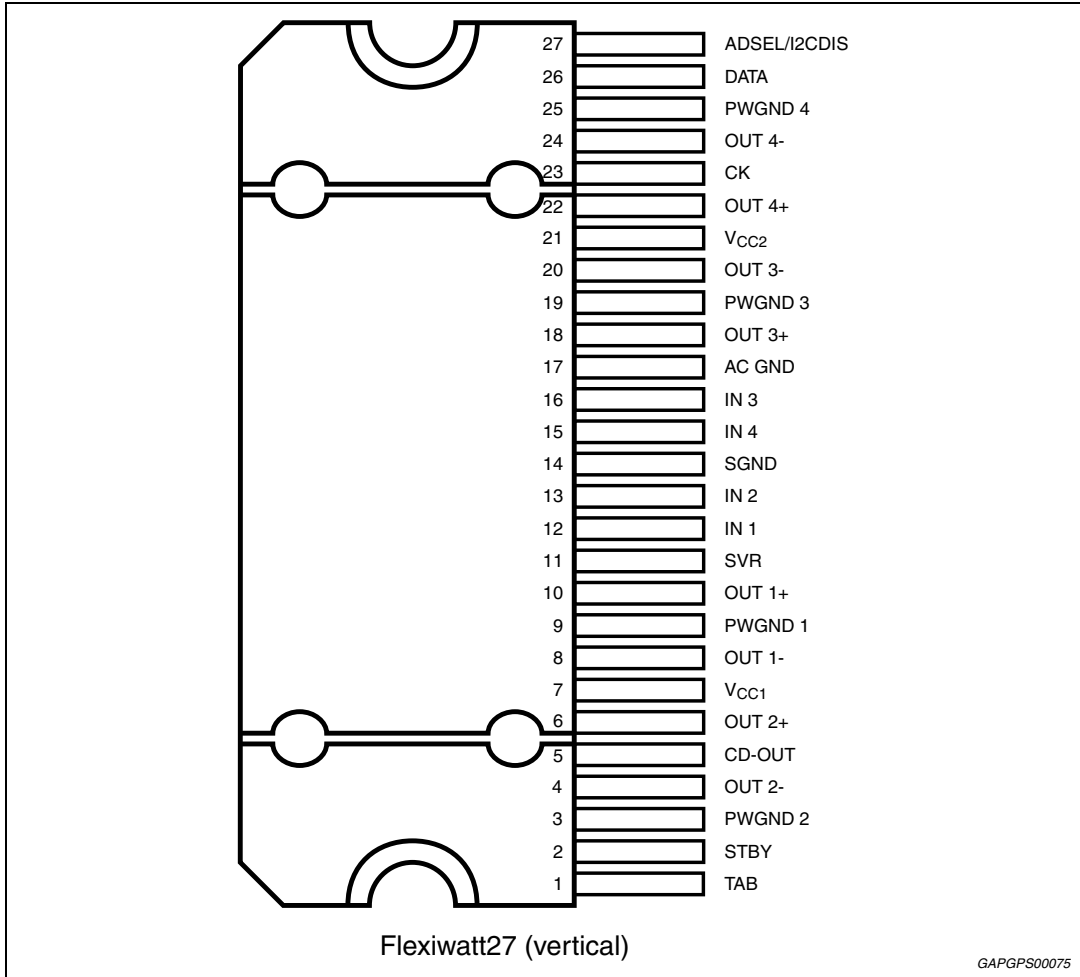

Table 2. Pins list description

| Pin # | Pin name | Function |
|-------|--------------|--|
| 1 | TAB | - |
| 2 | STBY | Standby pin |
| 3 | PWGND2 | Channel 2 output power ground |
| 4 | OUT2- | Channel 2, - output |
| 5 | CD | Clip detector output pin |
| 6 | OUT2+ | Channel 2, + output |
| 7 | VCC1 | Supply voltage pin1 |
| 8 | OUT1- | Channel 1, - output |
| 9 | PWGND1 | Channel 1 output power ground |
| 10 | OUT1+ | Channel 1, + output |
| 11 | SVR | SVR pin |
| 12 | IN1 | Input pin, channel 1 |
| 13 | IN2 | Input pin, channel 2 |
| 14 | SGND | Signal ground pin |
| 15 | IN4 | Input pin, channel 4 |
| 16 | IN3 | Input pin, channel 3 |
| 17 | AC GND | AC ground |
| 18 | OUT3+ | Channel 3, + output |
| 19 | PWGND3 | Channel 3 output power ground |
| 20 | OUT3- | Channel 3, - output |
| 21 | VCC2 | Supply voltage pin2 |
| 22 | OUT4+ | Channel 4, + output |
| 23 | CK | I ² C bus clock |
| 24 | OUT4- | Channel 4, - output |
| 25 | PWGND4 | Channel 4 output power ground |
| 26 | DATA | I ² C bus data pin/gain selector |
| 27 | ADSEL/I2CDIS | Address selector pin/ I ² C bus disable (legacy select) |

3 Electrical specifications

3.1 Absolute maximum ratings

Table 3. Absolute maximum ratings

| Symbol | Parameter | Value | Unit |
|--------------------|---|------------------|------------------|
| V_{op} | Operating supply voltage ⁽¹⁾ | 18 | V |
| V_S | DC supply voltage | 28 | V |
| V_{peak} | Peak supply voltage (for $t_{max} = 50$ ms) | 50 | V |
| GNDmax | Ground pins voltage | -0.3 to 0.3 | V |
| V_{CK}, V_{DATA} | CK and DATA pin voltage | -0.3 to 6 | V |
| V_{cd} | Clip detector voltage | -0.3 to 5.5 | V |
| V_{stby} | STBY pin voltage | -0.3 to V_{op} | V |
| I_O | Output peak current (not repetitive $t_{max} = 100$ ms) | 8 | A |
| | Output peak current (repetitive $f > 10$ kHz) | 6 | |
| P_{tot} | Power dissipation $T_{case} = 70^\circ\text{C}$ | 85 | W |
| T_{stg}, T_j | Storage and junction temperature ⁽²⁾ | -55 to 150 | $^\circ\text{C}$ |
| T_{amb} | Operative temperature range | -40 to +105 | $^\circ\text{C}$ |

1. For $R_L = 2 \Omega$ the output current limit might be reached for $V_{OP} > 16$ V; thus triggering self-protection.

2. A suitable dissipation system should be used to keep T_j inside the specified limits.

3.2 Thermal data

Table 4. Thermal data

| Symbol | Parameter | Value | Unit |
|------------------|--|-------|---------------------------|
| $R_{th\ j-case}$ | Thermal resistance junction-to-case Max. | 1 | $^\circ\text{C}/\text{W}$ |

3.3 Electrical characteristics

Refer to the test circuit, $V_S = 14.4\text{ V}$; $R_L = 4\ \Omega$; $f = 1\text{ kHz}$; $G_V = 30\text{ dB}$; $T_{\text{amb}} = 25\text{ }^\circ\text{C}$; unless otherwise specified.

Table 5. Electrical characteristics

| Symbol | Parameter | Test condition | Min. | Typ. | Max. | Unit |
|--------------------------------|---|---|------|-------|-------------------|------------------|
| General characteristics | | | | | | |
| V_S | Supply voltage range | $R_L = 4\ \Omega$ | 6 | - | 18 | V |
| | | $R_L = 2\ \Omega$ | 6 | - | 16 ⁽¹⁾ | |
| I_d | Total quiescent drain current | - | - | 165 | 250 | mA |
| R_{IN} | Input impedance | - | 45 | 60 | 70 | k Ω |
| V_{AM} | Min. supply mute threshold | IB1(D7) = 1 | 7 | - | 8 | V |
| | | IB1(D7) = 0 (default) ⁽²⁾ | 5 | - | 6 | |
| V_{OS} | Offset voltage | Mute & play | -100 | - | 100 | mV |
| V_{dth} | Dump threshold | - | 18.5 | - | 20.5 | V |
| I_{SB} | Standby current | $V_{\text{standby}} = 0$ | - | 1 | 5 | μA |
| SVR | Supply voltage rejection | $f = 100\text{ Hz to }10\text{ kHz}$; $V_r = 1\text{ Vpk}$; $R_g = 600\ \Omega$ | 60 | 70 | - | dB |
| T_{ON} | Turn on timing (Mute play transition) | D2/D1 (IB1) 0 to 1 | - | 25 | 50 | ms |
| T_{OFF} | Turn off timing (Play mute transition) | D2/D1 (IB1) 1 to 0 | - | 25 | 50 | ms |
| TH_{WARN1} | Average junction temperature for TH warning 1 | DB1 (D7) = 1 | - | 155 | - | $^\circ\text{C}$ |
| TH_{WARN2} | Average junction temperature for TH warning 2 | DB4 (D7) = 1 | - | 140 | - | |
| TH_{WARN3} | Average junction temperature for TH warning 3 | DB4 (D6) = 1 | - | 125 | - | |
| Audio performances | | | | | | |
| P_O | Output power | Max. power ⁽³⁾ $V_S = 15.2\text{ V}$, $R_L = 4\ \Omega$ | - | 45 | - | W |
| | | THD = 10 %, $R_L = 4\ \Omega$ | 23 | 25 | - | W |
| | | THD = 1 %, $R_L = 4\ \Omega$ | - | 22 | - | W |
| | | $R_L = 2\ \Omega$; THD 10 % | - | 44 | - | W |
| | | $R_L = 2\ \Omega$; THD 1 % | - | 33 | - | W |
| | | $R_L = 2\ \Omega$; Max. power ⁽³⁾ $V_S = 14.4\text{ V}$ | - | 64 | - | W |
| THD | Total harmonic distortion | $P_O = 1\text{ W to }10\text{ W}$ | - | 0.015 | 0.1 | % |
| | | $P_O = 1\text{--}10\text{ W}$, $f = 10\text{ kHz}$ | - | 0.15 | 0.5 | % |
| | | $G_V = 16\text{ dB}$; $V_O = 0.1\text{ to }5\text{ VRMS}$ | - | 0.01 | 0.05 | % |
| C_T | Cross talk | $f = 1\text{ kHz to }10\text{ kHz}$, $R_g = 600\ \Omega$ | 50 | 65 | - | dB |
| G_{V1} | Voltage gain 1 | - | 29 | 30 | 31 | dB |

Table 5. Electrical characteristics (continued)

| Symbol | Parameter | Test condition | Min. | Typ. | Max. | Unit |
|------------------------------------|--------------------------------|--|------|------|------|---------|
| ΔG_{V1} | Voltage gain match 1 | - | -1 | - | 1 | dB |
| G_{V2} | Voltage gain 2 | - | 15 | 16 | 17 | dB |
| ΔG_{V2} | Voltage gain match 2 | - | -1 | - | 1 | dB |
| E_{IN1} | Output noise voltage 1 | $R_g = 600 \Omega$ 20 Hz to 22 kHz | - | 65 | 80 | μV |
| E_{IN2} | Output noise voltage 2 | $R_g = 600 \Omega$; $GV = 16d B$ 20 Hz to 22 kHz | - | 20 | 30 | μV |
| BW | Power bandwidth | - | 100 | - | - | KHz |
| CMRR | Input CMRR | $V_{CM} = 1 V_{pk-pk}$; $R_g = 0 \Omega$ | - | 70 | - | dB |
| ΔV_{OITU} | ITU Pop filter output voltage | Standby to Mute and Mute to Standby transition $T_{amb} = 25 \text{ }^\circ C$, ITU-R 2K, $C_{svr} = 10 \mu F$ $V_s = 14.4 V$ | -7.5 | - | +7.5 | mV |
| | | Mute to Play transition $T_{amb} = 25 \text{ }^\circ C$, ITU-R 2K, $V_s = 14.4 V$ ⁽⁴⁾ | -10 | - | +10 | mV |
| | | Play to Mute transition $T_{amb} = 25 \text{ }^\circ C$, ITU-R 2K, $V_s = 14.4 V$ ⁽⁵⁾ | -10 | - | +10 | mV |
| Clip detector | | | | | | |
| CD_{LK} | Clip det. high leakage current | CD off / $V_{CD} = 6 V$ | - | 0 | 5 | μA |
| CD_{SAT} | Clip det sat. voltage | CD on; $I_{CD} = 1 mA$ | - | - | 300 | mV |
| CD_{THD} | Clip det THD level | D0 (IB1) = 1 | 5 | 10 | 15 | % |
| | | D0 (IB1) = 0 | 1 | 2 | 3 | % |
| Control pin characteristics | | | | | | |
| V_{SBY} | Standby/mute pin for standby | - | 0 | - | 1.2 | V |
| V_{MU} | Standby/mute pin for mute | - | 2.9 | - | 3.5 | V |
| V_{OP} | Standby/mute pin for operating | - | 4.5 | - | 18 | V |
| I_{MU} | Standby/mute pin current | $V_{st-by/mute} = 4.5 V$ | - | 1 | 5 | μA |
| | | $V_{st-by/mute} < 1.2 V$ | - | 0 | 5 | μA |
| A_{SB} | Standby attenuation | - | 90 | 110 | - | dB |
| A_M | Mute attenuation | - | 80 | 100 | - | dB |

Table 5. Electrical characteristics (continued)

| Symbol | Parameter | Test condition | Min. | Typ. | Max. | Unit |
|---|---|--|---------------------|------|---------------------|------|
| Turn on diagnostics 1 (Power amplifier mode) | | | | | | |
| Pgnd | Short to GND det. (below this limit, the Output is considered in short circuit to GND) | Power amplifier in standby | - | - | 1.2 | V |
| Pvs | Short to V _s det. (above this limit, the output is considered in short circuit to V _s) | | V _s -1.2 | - | - | V |
| Pnop | Normal operation thresholds. (Within these limits, the output is considered without faults). | | 1.8 | - | V _s -1.8 | V |
| Lsc | Shorted load det. | | - | - | 0.5 | Ω |
| Lop | Open load det. | | 85 | - | - | Ω |
| Lnop | Normal load det. | | 1.5 | - | 45 | Ω |
| Turn on diagnostics 2 (Line driver mode) | | | | | | |
| Pgnd | Short to GND det. (below this limit, the output is considered in short circuit to GND) | Power amplifier in standby | - | - | 1.2 | V |
| Pvs | Short to V _s det. (above this limit, the output is considered in short circuit to V _s) | - | V _s -1.2 | - | - | V |
| Pnop | Normal operation thresholds. (Within these limits, the output is considered without faults). | - | 1.8 | - | V _s -1.8 | V |
| Lsc | Shorted load det. | - | - | - | 1.5 | Ω |
| Lop | Open load det. | - | 330 | - | - | Ω |
| Lnop | Normal load det. | - | 7 | - | 180 | Ω |
| Permanent diagnostics 2 (Power amplifier mode or line driver mode) | | | | | | |
| Pgnd | Short to GND det. (below this limit, the Output is considered in short circuit to GND) | Power amplifier in mute or play, one or more short circuits protection activated | - | - | 1.2 | V |
| Pvs | Short to V _s det. (above this limit, the output is considered in short circuit to V _s) | | V _s -1.2 | - | - | V |
| Pnop | Normal operation thresholds. (Within these limits, the output is considered without faults). | | 1.8 | - | V _s -1.8 | V |
| L _{SC} | Shorted load det. | Power amplifier mode | - | - | 0.5 | Ω |
| | | Line driver mode | - | - | 1.5 | Ω |
| V _O | Offset detection | Power amplifier in play, AC input signals = 0 | ±1.5 | ±2 | ±2.5 | V |

Table 5. Electrical characteristics (continued)

| Symbol | Parameter | Test condition | Min. | Typ. | Max. | Unit |
|-------------------------------------|-------------------------------|---------------------------------------|------|------|------|------|
| I_{NLH} | Normal load current detection | $V_O < (V_S - 5)\mu k$, IB2 (D7) = 0 | 500 | - | - | mA |
| I_{OLH} | Open load current detection | | - | - | 250 | mA |
| I_{NLL} | Normal load current detection | $V_O < (V_S - 5)\mu k$, IB2 (D7) = 1 | 250 | - | - | mA |
| I_{OLL} | Open load current detection | | - | - | 125 | mA |
| I²C bus interface | | | | | | |
| S_{CL} | Clock frequency | - | - | - | 400 | kHz |
| V_{IL} | Input low voltage | - | - | - | 1.5 | V |
| V_{IH} | Input high voltage | - | 2.3 | - | - | V |

- When $V_S > 16\text{ V}$ the output current limit is reached (triggering embedded internal protections).
- In legacy mode only low threshold option is available.
- Saturated square wave output.
- Voltage ramp on STBY pin:
from 3.3 V to 4.2 V in $t \geq 40\text{ ms}$.
In case of I²C mode command IB1(D1) = 1 (Mute → Unmute rear channels) and/or IB1(D2) = 1 (Mute → Unmute front channels) must be transmitted before to start the voltage ramp on STBY pin.
- Voltage ramp on STBY pin:
from 4.05 V to 3.55 V in $t \geq 40\text{ ms}$.
In case of I²C mode command IB1(D1) = 0 Unmute → Mute rear channels) and/or IB1(D2) = 0 (Unmute → Mute front channels) must be NOT transmitted before to start the voltage ramp on STBY pin.

Figure 4. ITU R-ARM frequency response, weighting filter for transient pop

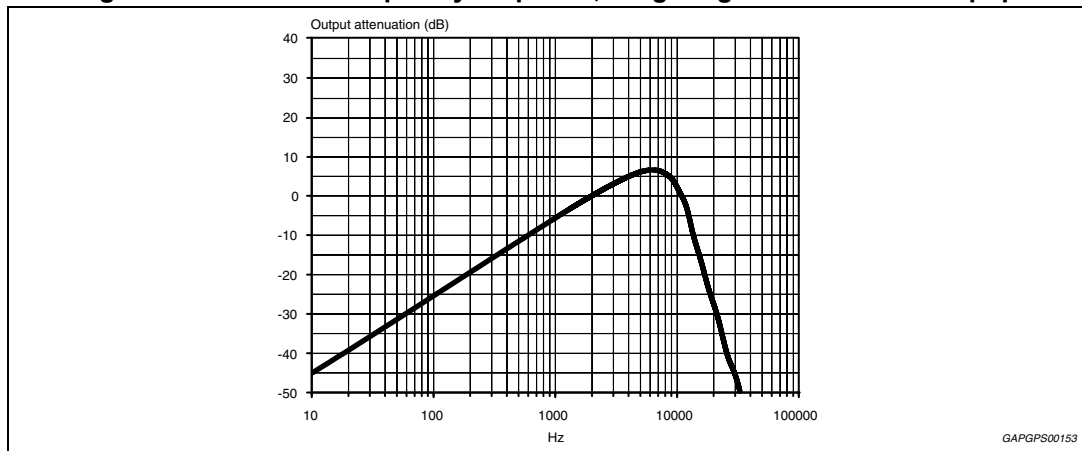

4 Diagnostics functional description

4.1 Turn-on diagnostic

It is recommended to activate this function at the turn-on (standby out) through an I²C bus request. Detectable output faults are:

- Short to GND
- Short to Vs
- Short across the speaker
- Open speaker

To verify if any of the above misconnections are in place, a subsonic (inaudible) current pulse (Figure 5) is internally generated, sent through the speaker(s) and sunk back. The Turn-on diagnostic status is internally stored until a successive diagnostic pulse is requested (after a I²C reading).

If the "standby out" and "diag. enable" commands are both given through a single programming step, the pulse takes place first (during the pulse the power stage stays 'off', showing high impedance at the outputs).

Afterwards, when the Amplifier is biased, the PERMANENT diagnostic takes place. The previous Turn-on state is kept until a short appears at the outputs.

Figure 5. Turn-on diagnostic: working principle

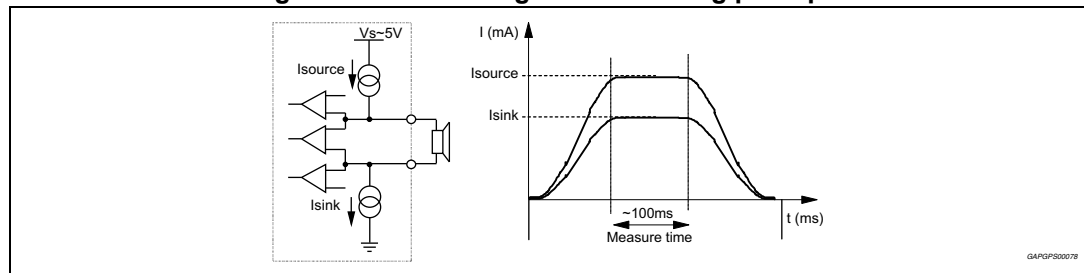

Figure 6 and 7 show SVR and OUTPUT waveforms at the turn-on (standby out) with and without turn-on diagnostic.

Figure 6. SVR and output behavior (Case 1: without turn-on diagnostic)

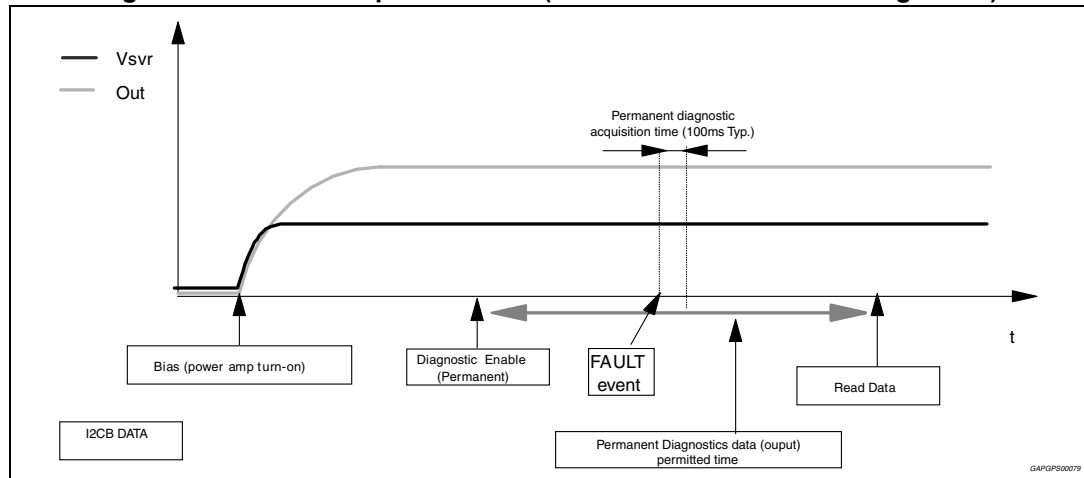
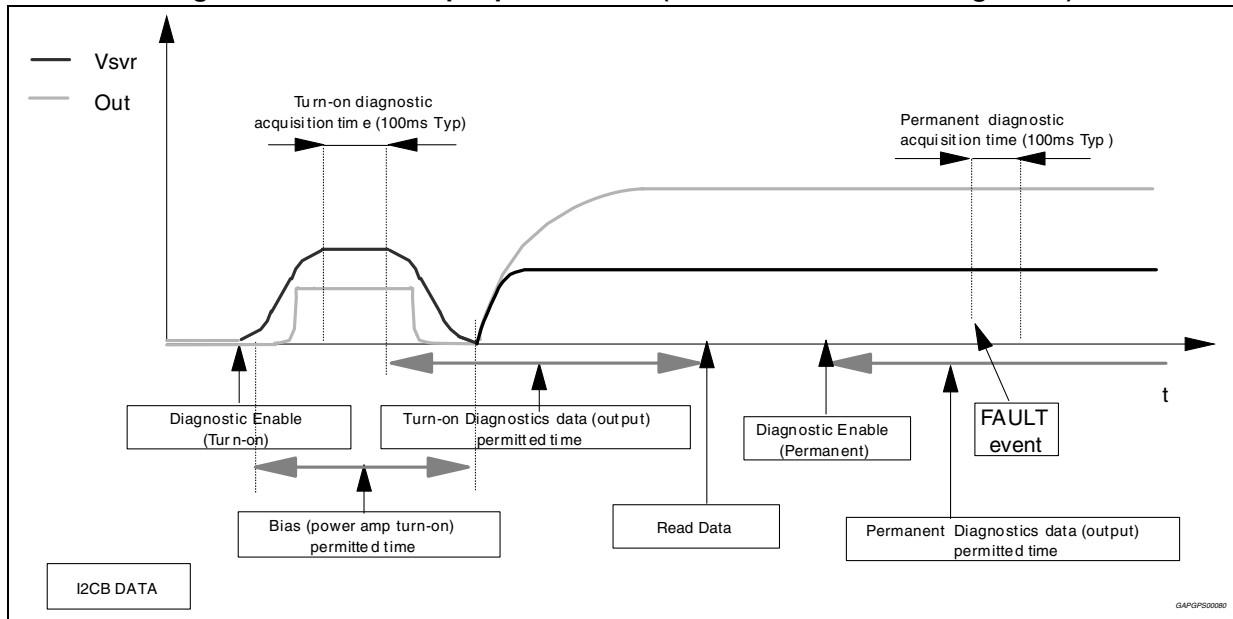
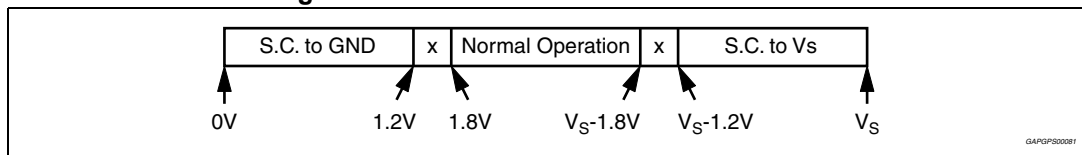

Figure 7. SVR and output pin behavior (Case 2: with turn-on diagnostic)



The information related to the outputs status is read and memorized at the end of the current pulse plateau. The acquisition time is 100 ms (typ.). No audible noise is generated in the process. As for Short to GND / V_s the fault-detection thresholds remain unchanged from 30 dB to 16 dB gain setting. They are as follows:

Figure 8. Short circuit detection thresholds



Concerning Short across the speaker / Open speaker, the threshold varies from 30 dB to 16 dB gain setting, since different loads are expected (either normal speaker's impedance or high impedance). The values in case of 30 dB gain are as follows:

Figure 9. Load detection thresholds - high gain setting

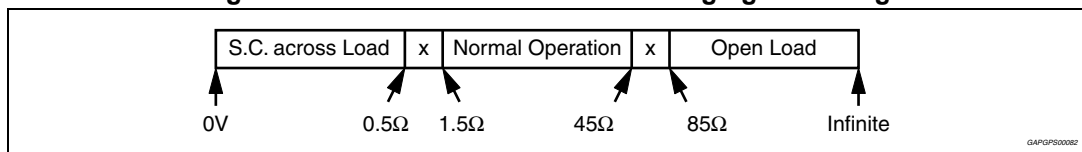

If the Line Driver mode ($G_v = 16$ dB and Line Driver Mode diagnostic = 1) is selected, the same thresholds will change as follows:

Figure 10. Load detection threshold - low gain setting

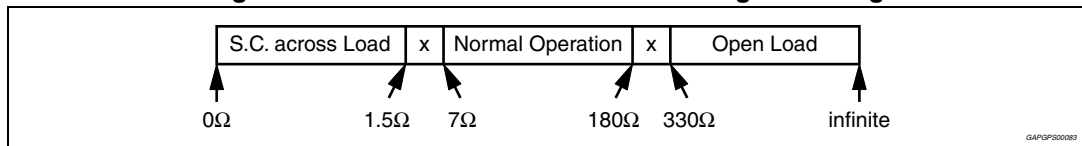

4.2 Permanent diagnostics

Detectable conventional faults are:

- Short to GND
- Short to V_s
- Short across the speaker

The following additional features is provided:

- Output offset detection (see [Section 5](#))

The TDA75612LV has 2 operating statuses:

1. **RESTART mode.** The diagnostic is not enabled. Each audio channel operates independently from each other. If any of the a.m. faults occurs, only the channel(s) interested is shut down. A check of the output status is made every 1 ms ([Figure 11](#)). Restart takes place when the overload is removed.
2. **DIAGNOSTIC mode.** It is enabled via I²C bus and self activates if an output overload (such to cause the intervention of the short-circuit protection) occurs to the speakers outputs. Once activated, the diagnostics procedure develops as follows ([Figure 12](#)):
 - To avoid momentary re-circulation spikes from giving erroneous diagnostics, a check of the output status is made after 1ms: if normal situation (no overloads) is detected, the diagnostic is not performed and the channel returns back active.
 - Instead, if an overload is detected during the check after 1 ms, then a diagnostic cycle having a duration of about 100 ms is started.
 - After a diagnostic cycle, the audio channel interested by the fault is switched to RESTART mode. The relevant data are stored inside the device and can be read by the microprocessor. When one cycle has terminated, the next one is activated by an I²C reading. This is to ensure continuous diagnostics throughout the car-radio operating time.
 - To check the status of the device a sampling system is needed. The timing is chosen at microprocessor level (over half a second is recommended).

Figure 11. Restart timing without diagnostic enable (permanent) - Each 1 mS time, a sampling of the fault is done

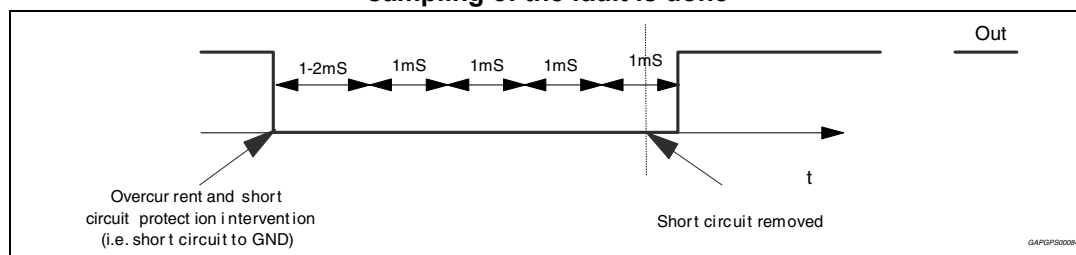
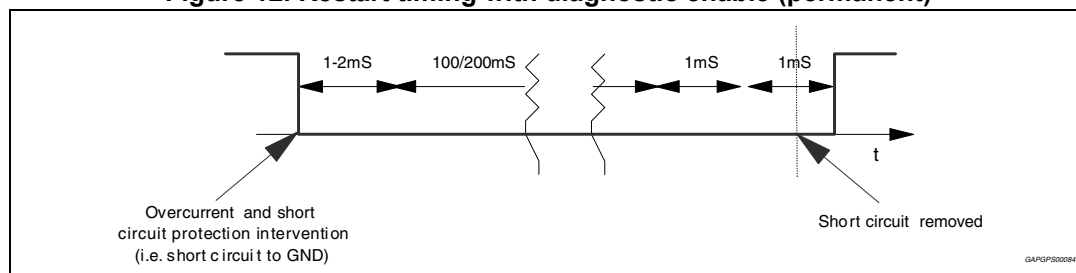

Figure 12. Restart timing with diagnostic enable (permanent)



4.3 AC diagnostic

It is targeted at detecting accidental disconnection of tweeters in 2-way speaker and, more in general, presence of capacitive (AC) coupled loads.

This diagnostic is based on the notion that the overall speaker's impedance (woofer + parallel tweeter) will tend to increase towards high frequencies if the tweeter gets disconnected, because the remaining speaker (woofer) would be out of its operating range (high impedance). The diagnostic decision is made according to peak output current thresholds, and it is enabled by setting $(IB2-D2) = 1$. Two different detection levels are available:

- High current threshold $IB2(D7) = 0$
 $I_{out} > 500 \text{ mApk}$ = normal status
 $I_{out} < 250 \text{ mApk}$ = open tweeter
- Low current threshold $IB2(D7) = 1$
 $I_{out} > 250 \text{ mApk}$ = normal status
 $I_{out} < 125 \text{ mApk}$ = open tweeter

To correctly implement this feature, it is necessary to briefly provide a signal tone (with the amplifier in "play") whose frequency and magnitude are such as to determine an output current higher than 500 mApk with $IB2(D7) = 0$ (higher than 250 mApk with $IB2(D7) = 1$) in normal conditions and lower than 250 mApk with $IB2(D7) = 0$ (lower than 125 mApk with $IB2(D7)=1$) should the parallel tweeter be missing.

The test has to last for a minimum number of 3 sine cycles starting from the activation of the AC diagnostic function $IB2<D2>$ up to the I²C reading of the results (measuring period). To confirm presence of tweeter, it is necessary to find at least 3 current pulses over the above threshold over all the measuring period, else an "open tweeter" message will be issued.

The frequency / magnitude setting of the test tone depends on the impedance characteristics of each specific speaker being used, with or without the tweeter connected (to be calculated case by case). High-frequency tones (> 10 kHz) or even ultrasonic signals are recommended for their negligible acoustic impact and also to maximize the impedance module's ratio between with tweeter-on and tweeter-off.

Figure 13 and *14* shows the load impedance as a function of the peak output voltage and the relevant diagnostic fields.

It is recommended to keep output voltage always below 8 V (high threshold case) or 4 V (low threshold case) to avoid the circuit to saturate (causing wrong detection cases).

This feature is disabled if any overloads leading to activation of the short-circuit protection occurs in the process.

Figure 13. Current detection high: load impedance |Z| vs. output peak voltage

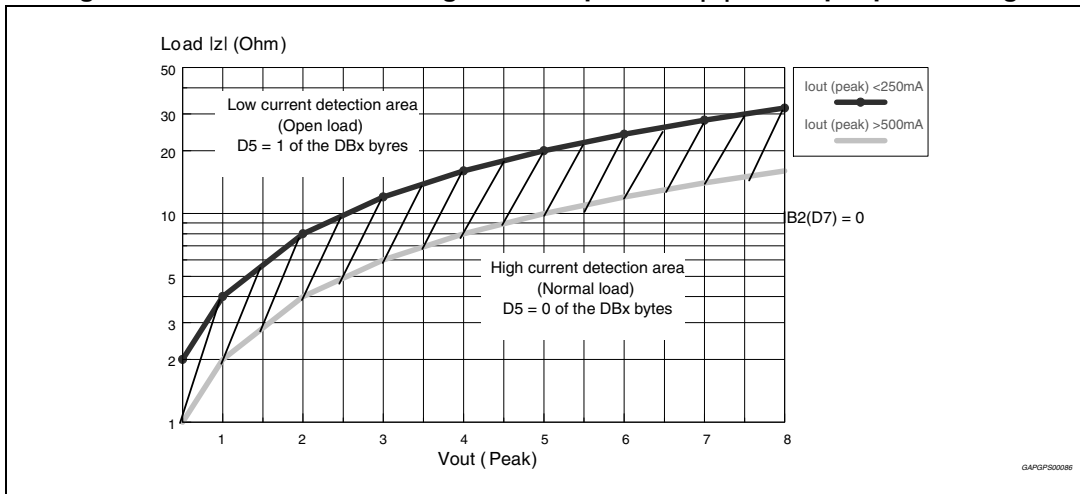
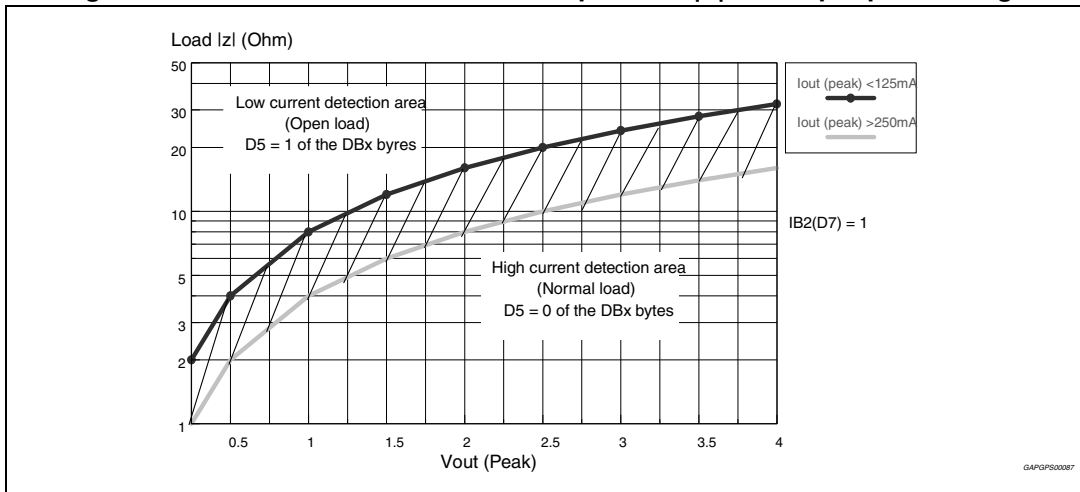

Figure 14. Current detection low: load impedance |Z| vs. output peak voltage



5 Output DC offset detection

The TDA75612LV can detect any DC output offset exceeding ± 2 V. This inconvenient might occur as a consequence of initially defective or aged and worn-out input capacitors feeding a DC component to the inputs, so putting the speakers at risk of overheating. Every time the power amplifier switches on, the SSR automatically mutes the device in case of offset. In play mode, the offset is signalled out on I²C bus.

5.1 Offset detection and mute at start-up, SSR (Speaker Safety Routine)

TDA75612LV embeds a speaker safety routine in order to protect the speakers in case of big output offset. This protection mechanism can automatically mute the device within 40 ms when it detects an offset bigger than 2 V at the output. No external circuit is required for this feature.

The SSR requires the MCU to turn on the audio power amplifier in a proper sequence. The MCU should at first turn on the device in MUTE condition and, after a suitable time to completely power on the device, which is about 1 s, send a PLAY command to it and make sure there is no signal applied to any of the inputs for at least 100 ms.

The SSR can be enabled acting on IB2-D0 bit.

See [Figure 15](#). The power amplifier switches on and no input signal is applied. After 1 s the SVR is fully charged and the output dc voltage is set. The MCU sends the PLAY command and the offset, on all the channels, is checked. In case the detected offset is null or, anyhow, lower than 2 V, the power amplifier is kept alive and the audio signal can be applied after 100 ms.

Figure 15. Power on sequence with a detected offset lower than 2 V

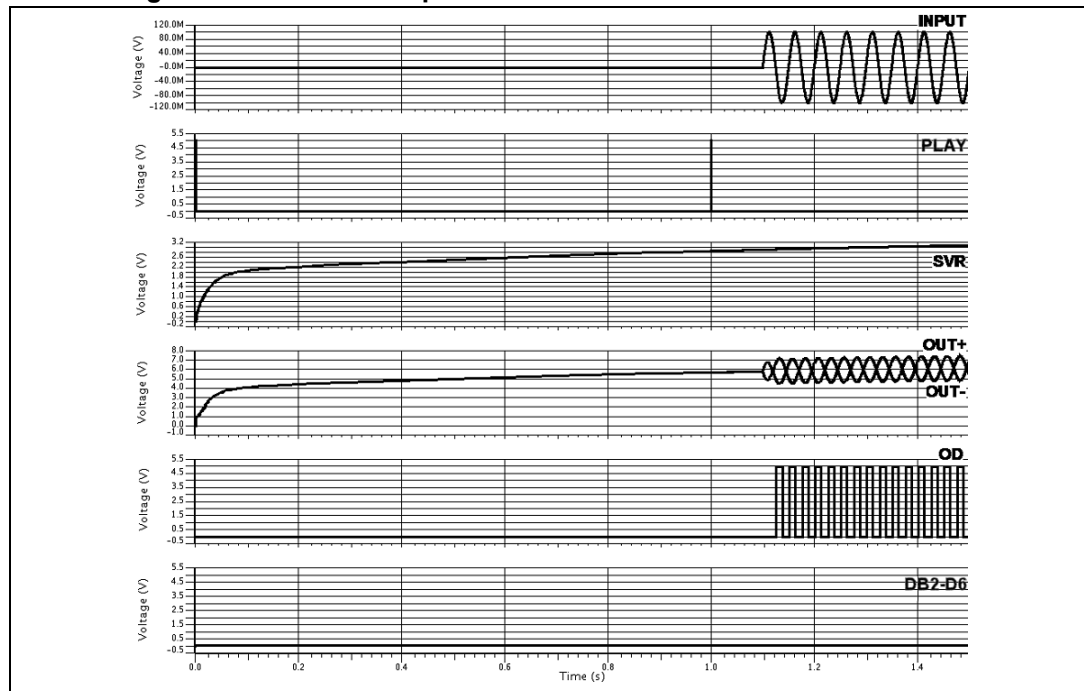

Look at the [Figure 16](#). The power amplifier switches on and no input signal is applied. After 1 s the SVR is fully charged and the output dc voltage is set. The MCU sends the PLAY command and the offset, on all the channels, is checked. If an offset bigger than 2 V is detected, the power amplifier is switched off within 40 ms.

Figure 16. Power on sequence with a detected offset higher than 2 V

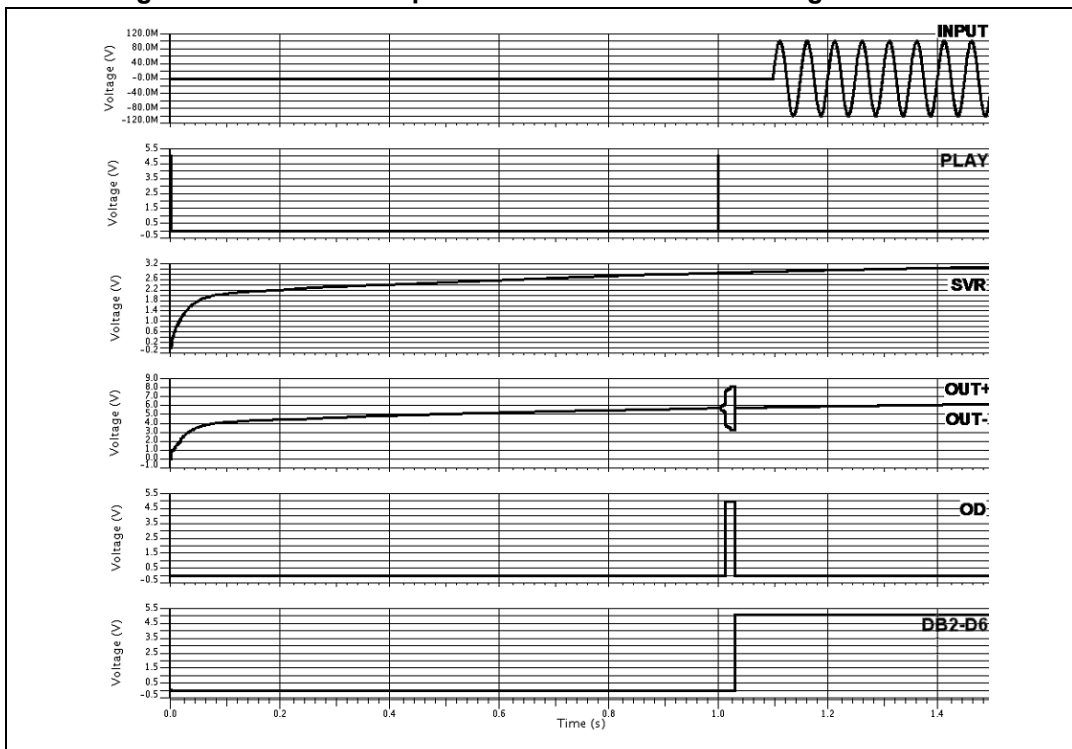

This action is pointed out on the I²C bus, bit DB2-D6. This flag is seen by the microcontroller which can take proper actions.

A standby command (hardware or by I²C) can reset the power amplifier

5.2 Offset detection in normal operation

It is a diagnostics function which has to be performed with low-level output AC signal (or $V_{in} = 0$).

The test is run with selectable time duration by microprocessor (from a "start" to a "stop" command):

- Start = Last reading operation or setting IB1 - D5 - (OFFSET enable) to 1
- Stop = Actual reading operation

Excess offset is signalled out if persistent throughout the assigned testing time. This feature is disabled if any overloads leading to activation of the short-circuit protection occurs in the process.

6 Multiple faults

When more misconnections are simultaneously in place at the audio outputs, it is guaranteed that at least one of them is initially read out. The others are notified after successive cycles of I²C reading and faults removal, provided that the diagnostic is enabled. This is true for both kinds of diagnostic (Turn-on and Permanent).

The table below shows all the couples of double-fault possible. It should be taken into account that a short circuit with the 4 Ω speaker unconnected is considered as double fault.

Table 6. Double fault table for turn on diagnostic

| | S. GND | S. Vs | S. Across L. | Open L. |
|--------------|--------|----------------|--------------|-------------|
| S. GND | S. GND | S. Vs + S. GND | S. GND | S. GND |
| S. Vs | / | S. Vs | S. Vs | S. Vs |
| S. Across L. | / | / | S. Across L. | N.A. |
| Open L. | / | / | / | Open L. (*) |

In Permanent Diagnostic the table is the same, with only a difference concerning Open Load (*), which is not among the recognizable faults. Should an Open Load be present during the device's normal working, it would be detected at a subsequent Turn-on Diagnostic cycle (i.e. at the successive Car Radio Turn-on).

6.1 Faults availability

All the results coming from I²C bus, by read operations, are the consequence of measurements inside a defined period of time. If the fault is stable throughout the whole period, it will be sent out.

To guarantee always resident functions, every kind of diagnostic cycle (Turn-on, Permanent, Offset) is activated again after any I²C reading operation. So, when the micro reads the I²C, a new cycle will be able to start, but the read data will come from the previous diag. cycle (i.e. The device is in Turn-on state, with a short to Gnd, then the short is removed and micro reads I²C. The short to GND is still present in bytes, because it is the result of the previous cycle. If another I²C reading operation occurs, the bytes do not show the short). In general to observe a change in Diagnostic bytes, two I²C reading operations are necessary.

7 Thermal protection

Thermal protection is implemented through thermal foldback (*Figure 17*).

Thermal foldback begins limiting the audio input to the amplifier stage as the junction temperatures rise above the normal operating range. This effectively limits the output power capability of the device thus reducing the temperature to acceptable levels without totally interrupting the operation of the device.

The output power will decrease to the point at which thermal equilibrium is reached. Thermal equilibrium will be reached when the reduction in output power reduces the dissipated power such that the die temperature falls below the thermal foldback threshold. Should the device cool, the audio level will increase until a new thermal equilibrium is reached or the amplifier reaches full power. Thermal foldback will reduce the audio output level in a linear manner.

Three thermal warning are available through the I²C bus data. After thermal shut down threshold is reached, the CD could toggle (as shown in *Figure 17*) or stay low, depending on signal level.

Figure 17. Thermal foldback diagram

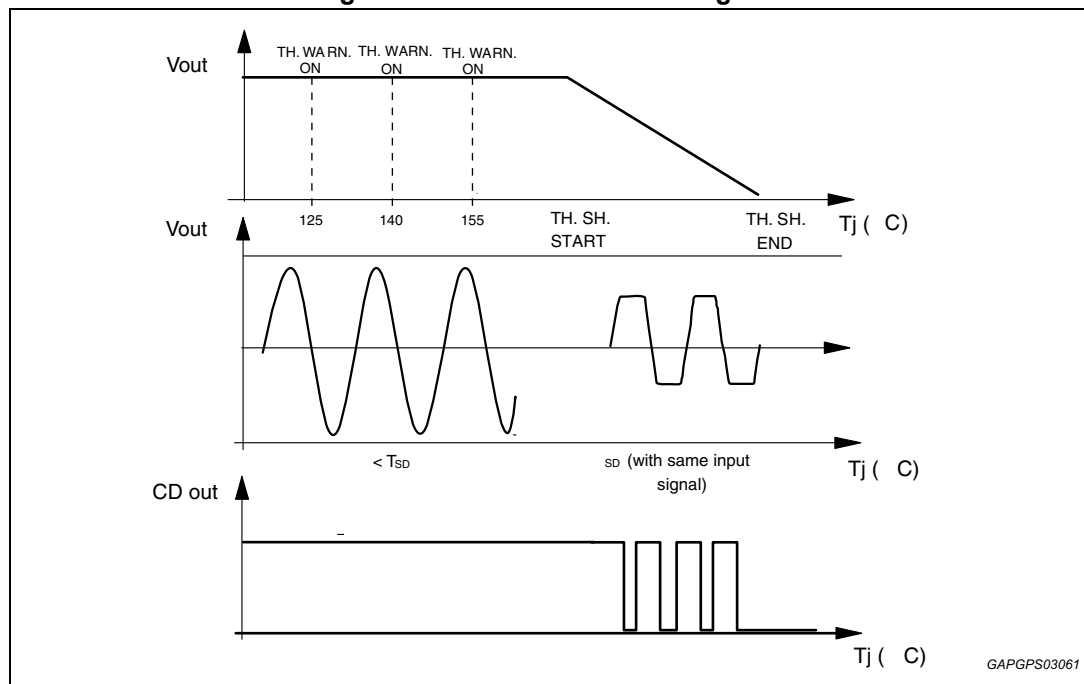

7.1 Fast muting

The muting time can be shortened to less than 1.5 ms by setting (IB2) D5 = 1. This option can be useful in transient battery situations (i.e. during car engine cranking) to quickly turnoff the amplifier for avoiding any audible effects caused by noise/transients being injected by preamp stages. The bit must be set back to "0" shortly after the mute transition.

8 Battery transitions management

8.1 Low voltage operation (“start stop”)

The most recent OEM specifications are requiring automatic stop of car engine at traffic light, in order to reduce emissions of polluting substances. The TDA75612LV, thanks to its innovating design, allows to go on playing sound when battery falls down to 6/7 V during such conditions, without producing pop noise. The maximum system power will be reduced accordingly.

Supported battery cranking curves are shown below, indicating the shape and durations of allowed battery transitions.

Figure 18. Worst case battery cranking curve sample 1

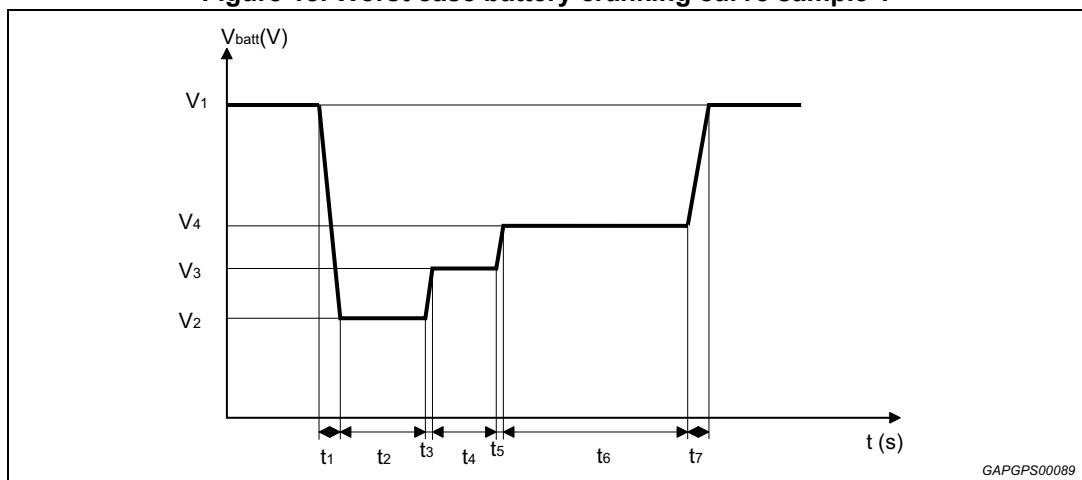

V1 = 12 V; V2 = 6 V; V3 = 7 V; V4 = 8 V

t1 = 2 ms; t2 = 50 ms; t3 = 5 ms; t4 = 300 ms; t5 = 10 ms; t6 = 1 s; t7 = 2 ms

Figure 19. Worst case battery cranking curve sample 2

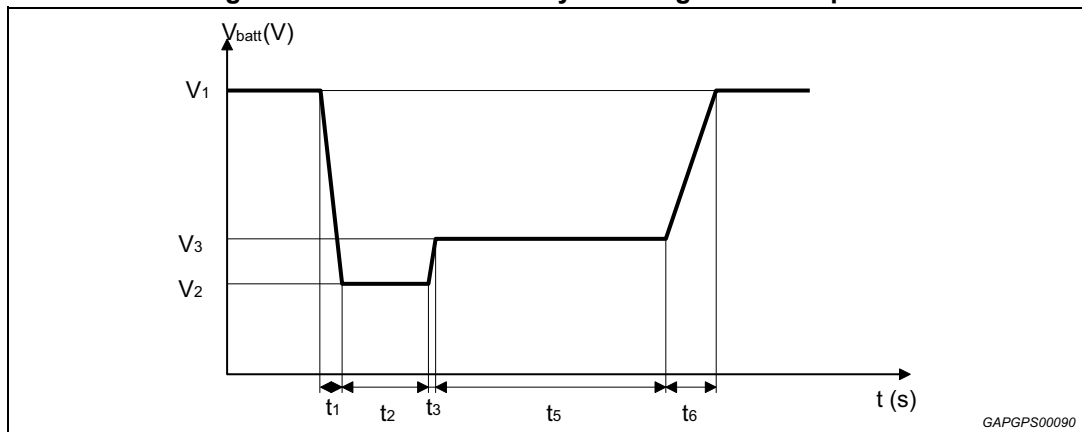

V1 = 12 V; V2 = 6 V; V3 = 7 V

t1 = 2 ms; t2 = 5 ms; t3 = 15 ms; t5 = 1 s; t6 = 50 ms

8.2 Advanced battery management

In addition to compatibility with low V_{batt} , the TDA75612LV is able to sustain upwards fast battery transitions (like the one showed in [Figure 20](#)) without causing unwanted audible effect, thanks to the innovative circuit topology.

Figure 20. Upwards fast battery transitions diagram

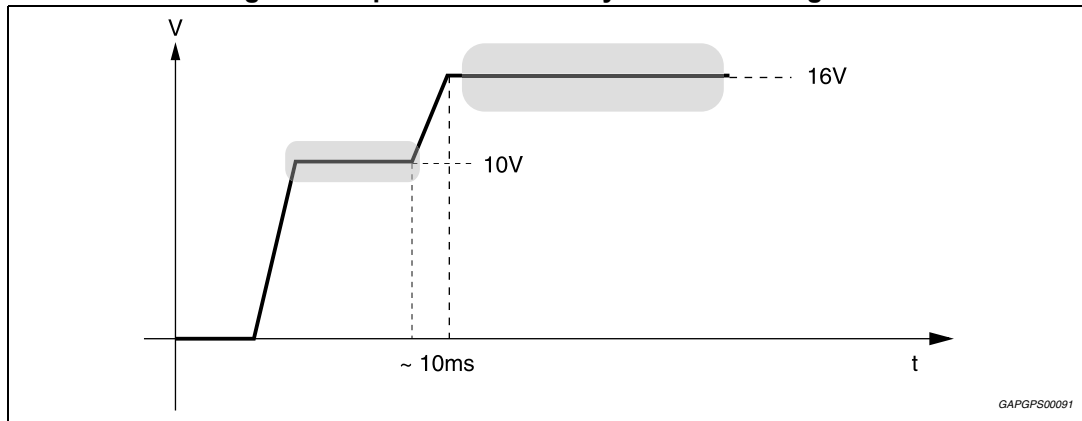

9 I²C bus

9.1 I²C programming/reading sequences

A correct turn on/off sequence with respect to the diagnostic timings and producing no audible noises could be as follows (after battery connection):

- Turn-on: PIN2 > 4.5 V - wait for 10 ms - (STAND-BY OUT + DIAG ENABLE) - wait for 1s - Muting out (play with no signal) - wait for 100ms
- Turn-off: MUTING IN - wait for 50 ms - HW ST-BY IN (ST-BY pin \leq 1.2 V)
- Car Radio Installation: PIN2 > 4.5 V - wait for 10 ms - DIAG ENABLE (write) - wait for 200 ms - I²C read (repeat until all faults disappear).

9.2 Address selection and I²C disable

When the ADSEL/I2CDIS pin is left open the I²C bus is disabled and the device can be controlled by the STBY/MUTE pin.

In this status (no - I²C bus) the DATA pin sets the gain (0 = 30 dB; 1 = 16 dB).

When the ADSEL/I2CDIS pin is connected to GND the I²C bus is active with address <1101100-x>.

To select the other I²C address a resistor must be connected to ADSEL/I2CDIS pin as following:

- $0 < R < 1 \text{ k}\Omega$: I²C bus active with address <1101100x>
- $11 \text{ k}\Omega < R < 21 \text{ k}\Omega$: I²C bus active with address <1101101x>
- $40 \text{ k}\Omega < R < 70 \text{ k}\Omega$: I²C bus active with address <1101110x>
- $R > 120 \text{ k}\Omega$: Legacy mode

(x: read/write bit sector)

9.3 I²C bus interface

Data transmission from microprocessor to the TDA75612LV and viceversa takes place through the 2 wires I²C bus interface, consisting of the two lines SDA and SCL (pull-up resistors to positive supply voltage must be connected).

9.3.1 Data validity

As shown by [Figure 21](#), the data on the SDA line must be stable during the high period of the clock. The HIGH and LOW state of the data line can only change when the clock signal on the SCL line is LOW.

9.3.2 Start and stop conditions

As shown by [Figure 22](#) a start condition is a HIGH to LOW transition of the SDA line while SCL is HIGH. The stop condition is a LOW to HIGH transition of the SDA line while SCL is HIGH.

9.3.3 Byte format

Every byte transferred to the SDA line must contain 8 bits. Each byte must be followed by an acknowledge bit. The MSB is transferred first.

9.3.4 Acknowledge

The transmitter* puts a resistive HIGH level on the SDA line during the acknowledge clock pulse (see [Figure 23](#)). The receiver** has to pull-down (LOW) the SDA line during the acknowledge clock pulse, so that the SDA line is stable LOW during this clock pulse.

* Transmitter:

- master (μP) when it writes an address to the TDA75612LV
- slave (TDA75612LV) when the μP reads a data byte from TDA75612LV

** Receiver:

- slave (TDA75612LV) when the μP writes an address to the TDA75612LV
- master (μP) when it reads a data byte from TDA75612LV

Figure 21. Data validity on the I²C bus

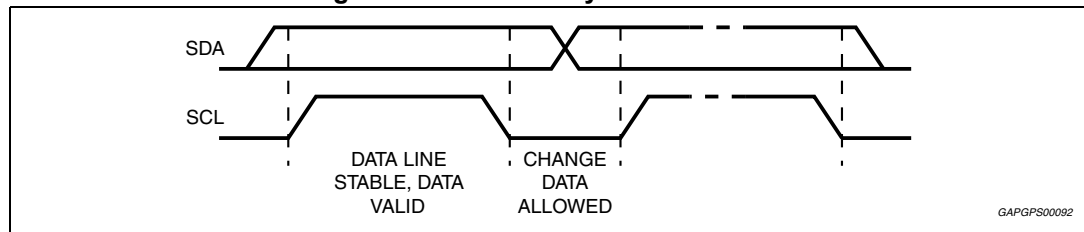

Figure 22. Timing diagram on the I²C bus

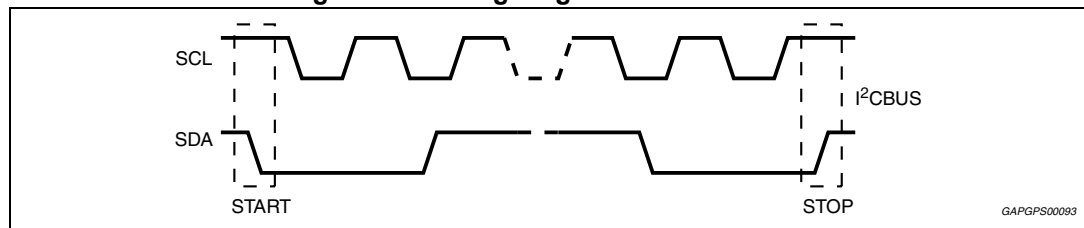
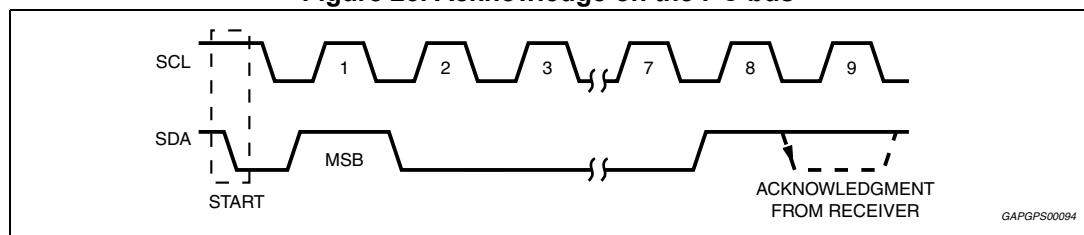

Figure 23. Acknowledge on the I²C bus



10 Software specifications

All the functions of the TDA75612LV are activated by I²C interface.

The bit 0 of the "ADDRESS BYTE" defines if the next bytes are write instruction (from μP to TDA75612LV) or read instruction (from TDA75612LV to μP).

Chip address

| | | | | | | | | |
|----|---|---|---|---|-----|-----|----|--------|
| D7 | | | | | | | D0 | |
| 1 | 1 | 0 | 1 | 1 | (*) | (*) | X | D8 Hex |

X = 0 Write to device
 X = 1 Read from device

If R/W = 0, the μP sends 2 "Instruction Bytes": IB1 and IB2.

(*) Address selector bit, please refer to address selection description on [Chapter 9.2](#).

Table 7. IB1

| Bit | Instruction decoding bit |
|-----|---|
| D7 | Supply transition mute threshold high (D7 = 1) Supply transition mute threshold low (D7 = 0) |
| D6 | Diagnostic enable (D6 = 1) Diagnostic defeat (D6 = 0) |
| D5 | Offset Detection enable (D5 = 1) Offset Detection defeat (D5 = 0) |
| D4 | Front Channel (CH1, CH3) Gain = 30 dB (D4 = 0) Gain = 16 dB (D4 = 1) |
| D3 | Rear Channel (CH2, CH4) Gain = 30 dB (D3 = 0) Gain = 16 dB (D3 = 1) |
| D2 | Mute front channels (D2 = 0) Unmute front channels (D2 = 1) |
| D1 | Mute rear channels (D1 = 0) Unmute rear channels (D1 = 1) |
| D0 | CD 2% (D0 = 0) CD 10% (D0 = 1) |

Table 8. IB2

| Bit | Instruction decoding bit |
|-----|---|
| D7 | Current detection threshold High th (D7 = 0) Low th (D7 =1) |
| D6 | 0 |
| D5 | Normal muting time (D5 = 0) Fast muting time (D5 = 1) |
| D4 | Stand-by on - Amplifier not working - (D4 = 0) Stand-by off - Amplifier working - (D4 = 1) |
| D3 | Power amplifier mode diagnostic (D3 = 0) Line driver mode diagnostic (D3 = 1) |
| D2 | Current Detection Diagnostic Enabled (D2 =1) Current Detection Diagnostic Defeat (D2 =0) |
| D1 | 0 |
| D0 | SSR disabled (D0 = 0) SSR enabled (D0 = 1) |

If R/W = 1, the TDA75612LV sends 4 "Diagnostics Bytes" to μP : DB1, DB2, DB3 and DB4.

Table 9. DB1

| Bit | Instruction decoding bit | |
|-----|---|--|
| D7 | Thermal warning 1 active (D7 = 1), $T_j = 160\text{ }^\circ\text{C}$ (Typ) - | |
| D6 | Diag. cycle not activated or not terminated (D6 = 0) Diag. cycle terminated (D6 = 1) - | |
| D5 | Channel LF (CH1) Current detection IB2 (D7) = 0 Output peak current < 250 mA - Open load (D5 = 1) Output peak current > 500 mA - Normal load (D5 = 0) | Channel LF (CH1) Current detection IB2 (D7) = 1 Output peak current < 125 mA - Open load (D5 = 1) Output peak current > 250 mA - Normal load (D5 = 0) |
| D4 | Channel LF (CH1) Turn-on diagnostic (D4 = 0) Permanent diagnostic (D4 = 1) - | |
| D3 | Channel LF (CH1) Normal load (D3 = 0) Short load (D3 = 1) - | |
| D2 | Channel LF (CH1) Turn-on diag.: No open load (D2 = 0) Open load detection (D2 = 1) Offset diag.: No output offset (D2 = 0) Output offset detection (D2 = 1) - | |

Table 9. DB1 (continued)

| Bit | Instruction decoding bit | |
|-----|---|---|
| D1 | Channel LF (CH1) No short to Vcc (D1 = 0) Short to Vcc (D1 = 1) | - |
| D0 | Channel LF (CH1) No short to GND (D1 = 0) Short to GND (D1 = 1) | - |

Table 10. DB2

| Bit | Instruction decoding bit | |
|-----|--|--|
| D7 | Offset detection not activated (D7 = 0) Offset detection activated (D7 = 1) | - |
| D6 | Offset detected and automute (SSR) (D6=1) | - |
| D5 | Channel LR (CH2) Current detection IB2 (D7) = 0 Output peak current < 250 mA - Open load (D5 = 1) Output peak current > 500 mA - Normal load (D5 = 0) | Channel LR (CH2) Current detection IB2 (D7) = 1 Output peak current < 125 mA - Open load (D5 = 1) Output peak current > 250 mA - Normal load (D5 = 0) |
| D4 | Channel LR (CH2) Turn-on diagnostic (D4 = 0) Permanent diagnostic (D4 = 1) | - |
| D3 | Channel LR (CH2) Normal load (D3 = 0) Short load (D3 = 1) | - |
| D2 | Channel LR (CH2) Turn-on diag.: No open load (D2 = 0) Open load detection (D2 = 1) Permanent diag.: No output offset (D2 = 0) Output offset detection (D2 = 1) | - |
| D1 | Channel LR (CH2) No short to Vcc (D1 = 0) Short to Vcc (D1 = 1) | - |
| D0 | Channel LR (CH2) No short to GND (D1 = 0) Short to GND (D1 = 1) | - |

Table 11. DB3

| Bit | Instruction decoding bit | |
|-----|--|--|
| D7 | Standby status (= IB2 - D4) | - |
| D6 | Diagnostic status (= IB1 - D6) | - |
| D5 | Channel RF (CH3) Current detection IB2 (D7) = 0 Output peak current < 250 mA - Open load (D5 = 1) Output peak current > 500 mA - Normal load (D5 = 0) | Channel RF (CH3) Current detection IB2 (D7) = 1 Output peak current < 125 mA - Open load (D5 = 1) Output peak current > 250 mA - Normal load (D5 = 0) |
| D4 | Channel RF (CH3) Turn-on diagnostic (D4 = 0) Permanent diagnostic (D4 = 1) | - |
| D3 | Channel RF (CH3) Normal load (D3 = 0) Short load (D3 = 1) | - |
| D2 | Channel RF (CH3) Turn-on diag.: No open load (D2 = 0) Open load detection (D2 = 1) Permanent diag.: No output offset (D2 = 0) Output offset detection (D2 = 1) | - |
| D1 | Channel RF (CH3) No short to Vcc (D1 = 0) Short to Vcc (D1 = 1) | - |
| D0 | Channel RF (CH3) No short to GND (D1 = 0) Short to GND (D1 = 1) | - |

Table 12. DB4

| Bit | Instruction decoding bit | |
|-----|--|--|
| D7 | Thermal warning 2 active (D7 = 1), $T_j = 145\text{ °C}$ (Typ) | - |
| D6 | Thermal warning 3 active (D6 = 1) $T_j = 125\text{ °C}$ (Typ) | - |
| D5 | Channel RR (CH4) Current detection IB2 (D7) = 0 Output peak current < 250 mA - Open load (D5 = 1) Output peak current > 500 mA - Normal load (D5 = 0) | Channel RR (CH4) Current detection IB2 (D7) = 1 Output peak current < 125 mA - Open load (D5 = 1) Output peak current > 250 mA - Normal load (D5 = 0) |
| D4 | Channel RR (CH4) Turn-on diagnostic (D4 = 0) Permanent diagnostic (D4 = 1) | - |
| D3 | Channel R (CH4) R Normal load (D3 = 0) Short load (D3 = 1) | - |
| D2 | Channel RR (CH4) Turn-on diag.: No open load (D2 = 0) Open load detection (D2 = 1) Permanent diag.: No output offset (D2 = 0) Output offset detection (D2 = 1) | - |
| D1 | Channel RR (CH4) No short to Vcc (D1 = 0) Short to Vcc (D1 = 1) | - |
| D0 | Channel RR (CH4) No short to GND (D1 = 0) Short to GND (D1 = 1) | - |

11 Examples of bytes sequence

1 - Turn-on diagnostic - Write operation

| | | | | | | | |
|-------|--------------------------|-----|-----------------|-----|-----|-----|------|
| Start | Address byte with D0 = 0 | ACK | IB1 with D6 = 1 | ACK | IB2 | ACK | STOP |
|-------|--------------------------|-----|-----------------|-----|-----|-----|------|

2 - Turn-on diagnostic - Read operation

| | | | | | | | | | | | |
|-------|--------------------------|-----|-----|-----|-----|-----|-----|-----|-----|-----|------|
| Start | Address byte with D0 = 1 | ACK | DB1 | ACK | DB2 | ACK | DB3 | ACK | DB4 | ACK | STOP |
|-------|--------------------------|-----|-----|-----|-----|-----|-----|-----|-----|-----|------|

The delay from 1 to 2 can be selected by software, starting from 1 ms

3a - Turn-on of the power amplifier with 30 dB gain, mute on, diagnostic defeat, CD = 2 %

| | | | | | | | |
|-------|--------------------------|-----|----------|-----|----------|-----|------|
| Start | Address byte with D0 = 0 | ACK | IB1 | ACK | IB2 | ACK | STOP |
| | | | X0000000 | | XXX1XX11 | | |

3b - Turn-off of the power amplifier

| | | | | | | | |
|-------|--------------------------|-----|----------|-----|----------|-----|------|
| Start | Address byte with D0 = 0 | ACK | IB1 | ACK | IB2 | ACK | STOP |
| | | | X0XXXXXX | | XXX0XXXX | | |

4 - Offset detection procedure enable

| | | | | | | | |
|-------|--------------------------|-----|----------|-----|----------|-----|------|
| Start | Address byte with D0 = 0 | ACK | IB1 | ACK | IB2 | ACK | STOP |
| | | | XX1XX11X | | XXX1XXXX | | |

5 - Offset detection procedure stop and reading operation (the results are valid only for the offset detection bits (D2 of the bytes DB1, DB2, DB3, DB4)

| | | | | | | | | | | | |
|-------|--------------------------|-----|-----|-----|-----|-----|-----|-----|-----|-----|------|
| Start | Address byte with D0 = 1 | ACK | DB1 | ACK | DB2 | ACK | DB3 | ACK | DB4 | ACK | STOP |
|-------|--------------------------|-----|-----|-----|-----|-----|-----|-----|-----|-----|------|

- The purpose of this test is to check if a D.C. offset (2 V typ.) is present on the outputs, produced by input capacitor with anomalous leakage current or humidity between pins.
- The delay from 4 to 5 can be selected by software, starting from 1ms

12 Package information

In order to meet environmental requirements, ST offers these devices in different grades of ECOPACK® packages, depending on their level of environmental compliance. ECOPACK® specifications, grade definitions and product status are available at: www.st.com.

ECOPACK® is an ST trademark.

Figure 24. Flexiwatt27 (vertical) mechanical data and package dimensions

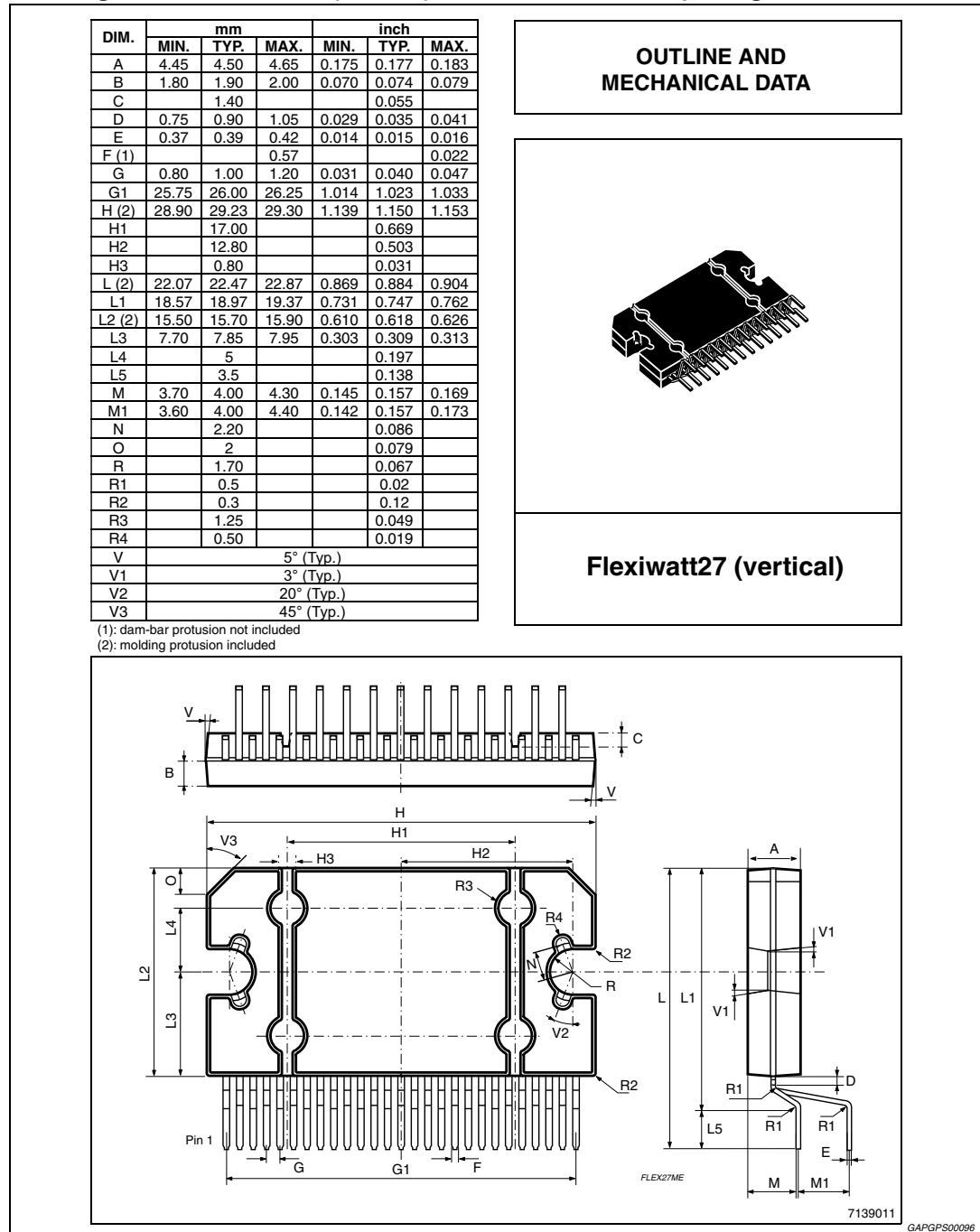

13 Revision history

Table 13. Document revision history

| Date | Revision | Changes |
|-------------|----------|---|
| 05-Dec-2012 | 1 | Initial release. |
| 10-Feb-2014 | 2 | Updated Section 9.1: I²C programming/reading sequences on page 25 . |
| 05-May-2014 | 3 | Updated Figure 17: Thermal foldback diagram on page 22 and Section 9.2: Address selection and I²C disable on page 25 . |
| 22-Sep-2014 | 4 | Updated Section 9.1: I²C programming/reading sequences on page 25 . |

IMPORTANT NOTICE – PLEASE READ CAREFULLY

STMicroelectronics NV and its subsidiaries ("ST") reserve the right to make changes, corrections, enhancements, modifications, and improvements to ST products and/or to this document at any time without notice. Purchasers should obtain the latest relevant information on ST products before placing orders. ST products are sold pursuant to ST's terms and conditions of sale in place at the time of order acknowledgement.

Purchasers are solely responsible for the choice, selection, and use of ST products and ST assumes no liability for application assistance or the design of Purchasers' products.

No license, express or implied, to any intellectual property right is granted by ST herein.

Resale of ST products with provisions different from the information set forth herein shall void any warranty granted by ST for such product.

ST and the ST logo are trademarks of ST. All other product or service names are the property of their respective owners.

Information in this document supersedes and replaces information previously supplied in any prior versions of this document.

© 2014 STMicroelectronics – All rights reserved