



# Table of Contents

## 1.0 INTRODUCTION

1-1 Features.....	3
1-2 Safety.....	4

## 2.0 SPECIFICATIONS

2-1 General Specifications .....	5
2-2 Electrical Specifications.....	5

## 3.0 METER DESCRIPTION .....

9

## 4.0 MEASUREMENT PREPARATION

4-1 The original screen.....	10
4-2 Entering the measurement Screen.....	10
4-3 Keypad Description Summary .....	10
4-4 SETUP Key .....	11
4-5 Meter Setup Functions (SD Card, PT/CT, Audible Beeper, Decimal Point, Clamp Type, RS-232, Time/Date, Reset Key) .....	12

## 5.0 MEASUREMENT PROCEDURES

5-1 1 $\Phi$ 2W (single phase two wires) measurement .....	25
5-2 1 $\Phi$ 3W (single phase three wires) measurement.....	26
5-3 3 $\Phi$ 3W (three phase three wires) measurement .....	27
5-4 3 $\Phi$ 4W (three phase four wires) measurement .....	28
5-5 CT and PT measurement .....	29
5-6 Data Logger .....	30
5-7 Data Hold.....	31
5-8 Display Backlight key.....	32
5-9 A (Current) Range key .....	33
5-10 LOWBAT (Low Battery) screen .....	34
5-11 Appendix - Measurement Definitions .....	35

## 6.0 MAINTENANCE

6-1 Cleaning.....	35
6-2 Battery Replacement.....	35

## 7.0 PC INTERFACE

7-1 RS-232 Protocol .....	36
7-2 Download Data from SD Card .....	37

# 1.0 Introduction

---

Congratulations on your purchase of the Model 382100 Power Analyzer. This instrument is fully tested and calibrated prior to delivery; proper use and care of this meter will provide years of reliable service.

## 1.1 Features

- Large dot-matrix, numerical, backlit LCD
- Full system analysis with up to 35 parameters:
  - V (phase-to-phase), V (phase-to-ground)
  - A (phase-to-ground)
  - KW / KVA / KVAR / PF (phase)
  - KW / KVA / KVAR / PF (system)
  - KWH / KVAH / KVARH / PFH (system)
  - Phase angle
- High accuracy Auto-ranging current clamps (0.2A to 1200.0A)
- 600.0VAC input with CAT III-600V safety rating
- Adjustable Current Transformer (CT) and Voltage Transformer (VT) ratio for high power distribution systems
- Log up to 30,000 readings on removable SD memory card in Excel® format
- Wide sampling rate range (from 2 seconds up to 2 hours)
- Captured measurements imported directly into Excel via the SD memory card
- Easy-to-use onscreen menu
- Easy-to-grab rugged over-molded housing

## 1.2 Safety

- CAUTION: Risk of electric shock. Do not attempt to open or disassemble the meter while taking measurements
- CAUTION: Do not attempt to measure Voltage or Current that exceeds specified limits
- Remove the test leads from the meter before opening the battery compartment cover
- When cleaning, use only a dry cloth to wipe the meter housing. Do not use liquids of any kind to clean the meter
- Safety Symbols:



### Environmental Conditions

- Installation Category III 600V
- Pollution Degree 2
- Altitude limit: 2000m
- Indoor use only
- Relative Humidity maximum: 80%

## 2.0 Specifications

### 2.1 General Specifications

Circuit	Custom one-chip microprocessor LSI circuit	
Display	LCD Size: 81.4 X 61 mm (3.2 X 2.4") Dot Matrix backlit LCD (320 X 240 pixels)	
Measurements	ACV / ACA / AC Watts (True Power) AC Watts (Apparent Power) AC Watts (Reactive Power) Power factor Phase angle Frequency	
Wire connections	1P/2W, 1P/3W, 3P/3W, 3P/4W.	
Voltage ranges	10 ACV to 600 ACV (Auto Range)	
Current ranges	0.2 ACA to 1200 ACA (Auto / Manual Range)	
Safety standard	IEC1010 CAT III 600 V	
ACV input impedance	10M ohms	
Range select	ACV	Auto Range
	ACA	Auto / Manual Range
Clamp frequency response	40 Hz to 1 KHz	
Tested frequency	45 to 65 Hz	
Over load protection	ACV	720 ACV RMS
	ACA	1300 ACA with clamp probe
Over-range indicator	"OL"	
Under-range indicator	"UR"	
Data Hold	Freezes displayed reading	
Data Recording	SD memory card	
Sampling Time	Approx. 1 second	
Datalogger	Real time data logger saves data to SD memory card for download to PC (data file opens directly to spreadsheet)	
	Sampling rate: 2 seconds to 7200 seconds	
Datalogger Error	≤ 0.1% of the total number of saved data (typical)	
Data Output	Serial or USB connection (cable supplied)	
Operating Temp.	0 to 50°C (0 to 122°F)	
Operating R.H.	80% Relative Humidity max.	
Power Supply	Eight (8) 'AA' 1.5VDC batteries or AC - DC 9V power adapter	
Power Consumption	Meter: 300 mA DC; Clamp: 34 mA DC	

Max. Conductor size	Clamp can accommodate up to 86 mm (3.4" ) diameter
Weight	Meter: 955g (2.1 lbs.) (with batteries); Clamp: 467g (1.0 lbs)
Dimensions	Meter: 225 X 125 X 64 mm (8.86 X 4.92 X 2.52")
	Clamp: 210 X 64 X 33mm (8.3 X 2.5 X 1.3")
	Clamp Jaw: 86 mm (3.4")
Accessories Included	Instruction manual Test Leads: 1 Set (4 pieces) Alligator clips: 1 Set (4 pieces) Clamp Probe (3) AC to DC 9V adapter SD card (4G) Carrying case

## 2.1 Electrical Specifications

**Note:** When the Active Power value (P1 to P3) and Apparent Power value (S1 to S3) shows the '-' sign, the current probe is positioned in reverse polarity with respect to the measured current.

### ACV

<i>Range</i>	<i>Resolution</i>	<i>Accuracy</i>
10.0V to 600.0V Phase to neutral line	0.1V	± (0.5%+0.5V)
10.0V to 600.0V Phase to phase		

### ACA

<i>Range</i>	<i>Resolution</i>	<i>Accuracy</i>
20A	0.001A (<10A) / 0.01A (≥10A)	± (0.5%+0.1A)
200A	0.01A (<100A) / 0.1A (≥100A)	± (0.5%+0.5A)
1200A	0.1A (<1000A) / 1A (≥1000A)	±(0.5%+5A)

### Power Factor

<i>Range</i>	<i>Resolution</i>	<i>Accuracy</i>
0.00 to 1.00	0.01	± 0.04

### PFH (Power Factor Hours): Long Term Power Factor

For 1Φ 3W configurations:

$$PF \Sigma = P \Sigma / S \Sigma$$

For 1Φ 2W configurations:

$$PF1 = P1 / S1$$

## Phase Angle

<b>Range</b>	<b>Resolution</b>	<b>Accuracy</b>
-180° to 180°	0.1°	± 1° * ACOS (PF)

## Frequency

<b>Range</b>	<b>Resolution</b>	<b>Accuracy</b>
45 to 65 Hz	0.1 Hz	0.1 Hz

## Active (Real) Power

<b>Range</b>	<b>Resolution</b>	<b>Accuracy</b>
0.000 to 9.999 KW	0.001/0.01/0.1 KW*	± (1%+0.008KW)
10.00 to 99.99 KW	0.01/0.1 KW*	± (1%+0.08KW)
100.0 to 999.9 KW	0.1 KW	± (1%+0.8KW)
1.000 to 9.999 MW	0.001 MW	± (1%+0.008MW)

\*Resolution changes according to ACA range

## Apparent Power

<b>Range</b>	<b>Resolution</b>	<b>Accuracy</b>
0.000 to 9.999 KVA	0.001/0.01/0.1 KVA*	± (1%+0.008KVA)
10.00 to 99.99 KVA	0.01/0.1 KVA*	± (1%+0.08KVA)
100.0 to 999.9 KVA	0.1 KVA	± (1%+0.8KVA)
1.000 to 9.999 MVA	0.001 MVA	± (1%+0.008MVA)

\*Resolution changes according to ACA range

## Reactive Power

<b>Range</b>	<b>Resolution</b>	<b>Accuracy</b>
0.000 to 9.999 KVAR	0.001/0.01/0.1 KVAR*	± (1%+0.008 KVAR)
10.00 to 99.99 KVAR	0.01/0.1 KVAR*	± (1%+0.08 KVAR)
100.0 to 999.9 KVAR	0.1 KVAR	± (1%+0.8 KVAR)
1.000 to 9.999 MVAR	0.001 MVAR	± (1%+0.008 MVAR)

\*Resolution changes according to ACA range

## Notes:

- When the Reactive power value (Q1 to Q3) shows the minus (-) sign, then the current phase lags the voltage phase (Inductive).
- When the Reactive power value (Q1 to Q3) does not show the (-) sign, then the current phase leads the voltage phase (Capacitive).

**Watt Hour (Active Power Hour): WH**

<b><i>Range</i></b>	<b><i>Resolution</i></b>	<b><i>Accuracy</i></b>
0.000 to 9.999 KWH	0.001 KWH	± (2%+0.008 KWH)
10.00 to 99.99 KWH	0.01 KWH	± (2%+0.08 KWH)
100.0 to 999.9 KWH	0.1 KWH	± (2%+0.8 KWH)
1.000 to 9.999 MWH	0.001 MWH	± (2%+0.008 MWH)

**VA Hour (Apparent Power Hour): SH**

<b><i>Range</i></b>	<b><i>Resolution</i></b>	<b><i>Accuracy</i></b>
0.000 to 9.999 KVAH	0.001 KVAH	± (2%+0.008 KVAH)
10.00 to 99.99 KVAH	0.01 KVAH	± (2%+0.08 KVAH)
100.0 to 999.9 KVAH	0.1 KVAH	± (2%+0.8 KVAH)
1.000 to 9.999 MVAH	0.001 MVAH	± (2%+0.008 MVAH)

**VAR Hour (Reactive Power Hour): QH**

<b><i>Range</i></b>	<b><i>Resolution</i></b>	<b><i>Accuracy</i></b>
0.000 to 9.999 KVARH	0.001 KVARH	± (2%+0.008 KVARH)
10.00 to 99.99 KVARH	0.01 KVARH	± (2%+0.08 KVARH)
100.0 to 999.9 KVARH	0.1 KVARH	± (2%+0.8 KVARH)
1.000 to 9.999 MVARH	0.001 MVARH	± (2%+0.008 MVARH)

## 3.0 Meter Description

- 3-1 Display
- 3-2 Phase/Wire button
- 3-3 ▲ button
- 3-4 ▼ button
- 3-5 Hold button
- 3-6 Backlight button
- 3-7 Power button
- 3-8 Exit button
- 3-9 REC button
- 3-10 Amp range button
- 3-11 Shift button
- 3-12 Setup button
- 3-13 Volt input terminals
- 3-14 Probe input sockets
- 3-15 SD card socket
- 3-16 RS232 socket
- 3-17 Reset button
- 3-18 9V adapter socket
- 3-19 Battery compartment
- 3-20 Stand
- 3-21 Current Sense Jaw
- 3-22 Trigger
- 3-23 Plug for current probe

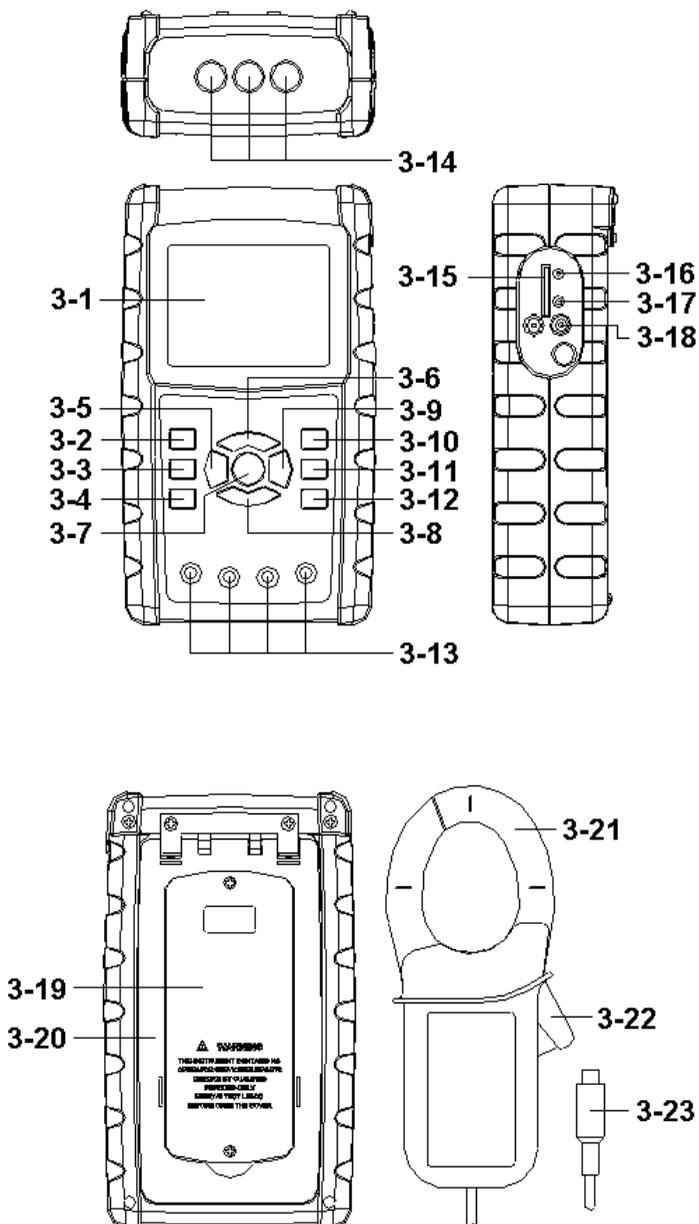

## 4.0 Measurement Preparation

### 4-1 Opening Screen

1. When the meter is powered up the initialization screen appears asking the user to "please wait".
2. The meter will also check for an inserted SD memory card. 'SD check' will appear on the screen. If an SD card is inserted, the blinking display will switch off after several seconds. When no card is inserted the display will show 'No disk'.

### 4-2 Main Screen

The main screen displays all of the power measurement data.

Figure 4-2: Main Screen

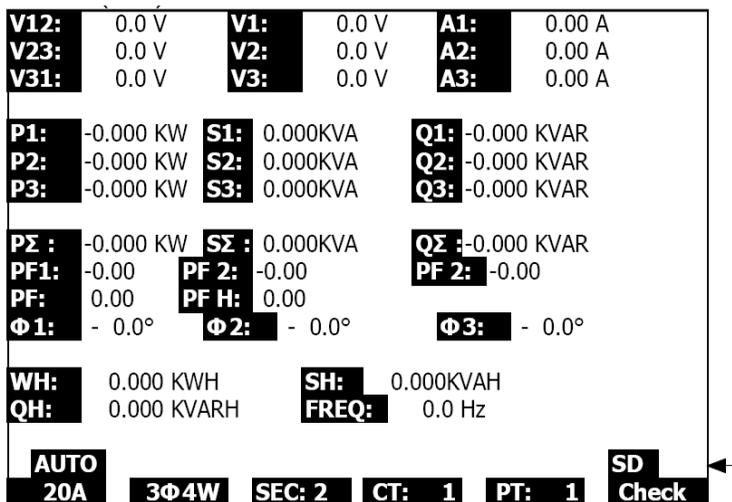

### 4.3 Keypad layout

1. POWER KEY (3-7, Fig. 1): Press to turn the instrument ON/OFF
2. 1Φ 3Φ (phase/wire) KEY (3-2, Fig. 1): Press to select (1P/2W, 1P/3W, 3P/3W, 3P/4W) measurement function
3. A (current) RANGE KEY (3-10, Fig. 1): Press to change from AUTO RANGE to MANUAL RANGE mode for current
4. REC KEY (3-9, Fig. 1): The data record key for the SD Memory Card
5. HOLD KEY (3-5, Fig. 1): Press to freeze the displayed reading
6. BACKLIGHT KEY (3-6, Fig. 1): Press to switch LCD backlight ON/OFF
7. SETUP KEY (3-12, Fig. 1): Press to setup a function before measuring
8. EXIT KEY (3-8, Fig. 1): Press to exit the set-up screen
9. SHIFT KEY (3-11, Fig. 1): Used for programming the functions on the set-up screen
10. UP (▲) KEY (3-3, Fig. 1): Press to move the cursor up
11. DOWN (▼) KEY (3-4, Fig. 1): Press to move the cursor down

## 4.4 Setup Key Descriptions

### 4.4.1 SHIFT KEY

**SHIFT 1:** When the symbols " SETUP " and " SHIFT 1 " appear on the upper right hand portion (Fig. 4-4a), use the ▲ or ▼ key to select the an item.

**SHIFT 2:** When the symbols " SETUP " and " SHIFT 2 " appear on the upper right hand portion of the display (Fig. 4-4b), use the ▲ or ▼ key to select 1P/2W, 1P/3W, 3P/3W, or 3P/4W for the File Name function.

Figure 4-4a: SHIFT Key (Screen 1)

Folder Name:	WTA01					<b>SETUP</b>
<b>File Name:</b>	3P401001.XLS					<b>SHIFT 1</b>
REC Date:	2008-11-28 00:03:17					
Sampling Time:	2					
Delet File:	0 %					
SD Format:	0 %					
Use Size:	388 KB	Decimal:	Basic			
Free Size:	1946 MB	Clamp Type:	1200A			
Total Size:	1946 MB	RS232 Out Sel:				
PT:	1 : 1	V1	I1	P1		
CT:	1 : 1	S1	Q1	PF1		
Beep:	ON	Φ 1	WH	FREQ		
Year	Month	Date	Hour	Minute	Second	
2008	12	05	11	15	18	

Figure 4-4b: SHIFT Key (Screen 2)

Folder Name:	WTA01					<b>SETUP</b>
<b>File Name:</b>	3P401001.XLS					<b>SHIFT 2</b>
REC Date:	2008-11-28 00:03:17					
Sampling Time:	2					
Delet File:	0 %					
SD Format:	0 %					
Use Size:	388 KB	Decimal:	Basic			
Free Size:	1946 MB	Clamp Type:	1200A			
Total Size:	1946 MB	RS232 Out Sel:				
PT:	1 : 1	V1	I1	P1		
CT:	1 : 1	S1	Q1	PF1		
Beep:	ON	Φ 1	WH	FREQ		
Year	Month	Date	Hour	Minute	Second	
2008	12	05	11	15	18	

#### 4.4.2 The Setup Function Menu

- Folder Name: Select a name on the SD CARD; the range is WTA01 to WTA10
- File Name: Set a file name on the SD CARD (50 filenames are permitted)
- REC Date: Show a file's date-time stamp (Year / Month / Date / Hour / Min / Sec)
- Sampling Time: Set the sampling rate from 2 to 7200 seconds
- Delete File: Delete an existing data file from the SD CARD
- SD Format: Format the SD CARD
- PT: Set the Potential Transformer from 1 to 1000
- CT: Set the Current Transformer from 1 to 600
- Audible Tone: Set ON or OFF
- Clamp Type: Select 200A or 1200A
- RS232 out Select: RS232 output function (up to nine items can be output)
- Year: Set the year.
- Month: Set the month
- Date: Set the date
- Hour: Set the hour
- Minute: Set the minute
- Second: Set the second

#### 4.5 Meter Setup Functions

Press SETUP to enter the Function screen, selected items will appear as highlighted.

##### 4.5.1 Folder name: Set a folder name in the SC Memory Card

1. The Folder Name range is "WTA01" to "WTA10"
2. Press ▲ or y to select a folder number, the available numbers are "01 to 10"
3. Press ▲ or y continuously for at least two seconds to scroll quickly.
4. Press SHIFT once, the symbol " SHIFT1" will appear; then press y to enter Screen 2 (Folder Name -> File Name)

Figure 4-5-1a: Folder Name (Screen 1)

<b>Folder Name:</b>	WTA01					<b>SETUP</b>
File Name:	3P401001.XLS					
REC Date:	2008-11-28 00:03:17					
Sampling Time:	2					
Delete File:	0 %					
SD Format:	0 %					
Use Size:	388 KB	Decimal:	Basic			
Free Size:	1946 MB	Clamp Type:	1200A			
Total Size:	1946 MB	RS232 Out Sel:				
PT:	1 : 1	V1	I1	P1		
CT:	1 : 1	S1	Q1	PF1		
Beep:	ON	Φ1	WH	FREQ		
Year	Month	Date	Hour	Minute	Second	
2008	12	05	11	14	49	

Figure 4-5-1b: Folder Name (Screen 2)

<b>Folder Name:</b>	WTA01					<b>SETUP</b>
File Name:	3P401001.XLS					<b>SHIFT 1</b>
REC Date:	2008-11-28 00:03:17					
Sampling Time:	2					
Delet File:	0 %					
SD Format:	0 %					
Use Size:	388 KB	Decimal:	Basic			
Free Size:	1946 MB	Clamp Type:	1200A			
Total Size:	1946 MB	RS232 Out Sel:				
PT:	1 : 1	V1	I1	P1		
CT:	1 : 1	S1	Q1	PF1		
Beep:	ON	Φ1	WH	FREQ		
Year	Month	Date	Hour	Minute	Second	
2008	12	05	11	14	34	

**4.5.2 File name: Set a file name in the SC Memory Card**

1. The screen will show the " NO File " indicator in the REC Date option area when the selected file is new
2. The screen will show the recording date and time in the REC Date option area for existing data files

Figure 4-5-2a: File Name (Screen 1)

<b>Folder Name:</b>	WTA03					<b>SETUP</b>
<b>File Name:</b>	3P401001.XLS					
REC Date:	NO File					
Sampling Time:	2					
Delet File:	0 %					
SD Format:	0 %					
Use Size:	388 KB	Decimal:	Basic			
Free Size:	1946 MB	Clamp Type:	1200A			
Total Size:	1946 MB	RS232 Out Sel:				
PT:	1 : 1	V1	I1	P1		
CT:	1 : 1	S1	Q1	PF1		
Beep:	ON	Φ1	WH	FREQ		
Year	Month	Date	Hour	Minute	Second	
2008	12	05	15	10	55	

Figure 4-5-2b: File Name (Screen 2)

<b>Folder Name:</b>	WTA01					<b>SETUP</b>
<b>File Name:</b>	3P401001.XLS					
REC Date:	2008-11-28 00:03:17					
Sampling Time:	2					
Delet File:	0 %					
SD Format:	0 %					
Use Size:	388 KB	Decimal:	Basic			
Free Size:	1946 MB	Clamp Type:	1200A			
Total Size:	1946 MB	RS232 Out Sel:				
PT:	1 : 1	V1	I1	P1		
CT:	1 : 1	S1	Q1	PF1		
Beep:	ON	Φ1	WH	FREQ		
Year	Month	Date	Hour	Minute	Second	
2008	12	05	11	15	31	

- File Name description: press ▲ or y in screen 2 (Fig. 4-5-2b) to select a file number from 001 to 050.

Note: When pressing ▲ or y for more than 2 seconds, quicker scrolling will result.

**Examples:**

**1P201001:** 1P2 is one phase by two wires, 01 is the folder number, and 001 is the file number

**1P301001:** 1P3 is one phase by three wires, 01 is the folder number, and 001 is the file number

**3P301001:** 3P3 is three phases by three wires, 01 is the folder number, and 001 is the file number.

**3P401001:** 3P4 is three phases by four wires, 01 is the folder number, and 001 is the file number.

- The display will show the " SHIFT1 " symbol when the SHIFT KEY is pressed once from screen 2 (Fig. 4-5-2b); press y to enter Screen 3 (File Name ~ Sampling Time)
- The display will show the " SHIFT2 " symbol when the SHIFT KEY is pressed again in screen 4 (Fig. 4-5-2d), use ▲ or ▼ to select 1P/2W(1P2), 1P/3W(1P3), 3P/3W(3P3), or 3P/4W(3P4)
- Now use the SHIFT KEY to select the desired functions

Figure 4-5-2c: File Name (Screen 3)

Folder Name: WTA01						<b>SETUP SHIFT 1</b>
<b>File Name:</b> 3P401001.XLS						
REC Date: 2008-11-28 00:03:17						
Sampling Time: 2						
Delet File: 0 %						
SD Format: 0 %						
Use Size: 388 KB		Decimal: Basic				
Free Size: 1946 MB		Clamp Type: 1200A				
Total Size: 1946 MB RS232 Out Sel:						
PT:	1 : 1	V1	I1	P1		
CT:	1 : 1	S1	Q1	PF1		
Beep:	ON	Φ1	WH	FREQ		
Year	Month	Date	Hour	Minute	Second	
2008	12	05	11	15	06	

Figure 4-5-2d: File Name (Screen 4)

Folder Name: WTA01						<b>SETUP SHIFT 2</b>
<b>File Name:</b> 3P401001.XLS						
REC Date: 2008-11-28 00:03:17						
Sampling Time: 2						
Delet File: 0 %						
SD Format: 0 %						
Use Size: 388 KB		Decimal: Basic				
Free Size: 1946 MB		Clamp Type: 1200A				
Total Size: 1946 MB RS232 Out Sel:						
PT:	1 : 1	V1	I1	P1		
CT:	1 : 1	S1	Q1	PF1		
Beep:	ON	Φ1	WH	FREQ		
Year	Month	Date	Hour	Minute	Second	
2008	12	05	11	15	18	

#### 4.5.3 Set the Sampling Time (datalogging rate) for the SD Memory Card

1. When the SHIFT KEY is pressed once, the symbol " SHIFT1 " will switch off, use ▲ or ▼ to adjust the sampling time, the range is 2 to 7200 seconds
2. The display will show the " SHIFT1 " symbol after the SHIFT KEY is pressed again, press ▼ to enter the next setting (Sampling Time ~ Delete File)

Figure 4-5-3a: Sampling Rate (Screen 1)

Folder Name:	WTA01					<b>SETUP</b>
File Name:	3P401001.XLS					<b>SHIFT 1</b> ←
REC Date:	2008-11-28 00:03:17					
<b>Sampling Time:</b>	2					
Delet File:	0 %					
SD Format:	0 %					
Use Size:	388 KB	Decimal:	Basic			
Free Size:	1946 MB	Clamp Type:	1200A			
Total Size:	1946 MB	RS232 Out Sel:				
PT:	1 : 1	V1	I1	P1		
CT:	1 : 1	S1	Q1	PF1		
Beep:	ON	Φ1	WH	FREQ		
Year	Month	Date	Hour	Minute	Second	
2008	12	05	11	15	51	

Figure 4-5-3b: Sampling Rate (Screen 2)

Folder Name:	WTA01					<b>SETUP</b>
File Name:	3P401001.XLS					
REC Date:	2008-11-28 00:03:17					
<b>Sampling Time:</b>	2					
Delet File:	0 %					
SD Format:	0 %					
Use Size:	388 KB	Decimal:	Basic			
Free Size:	1946 MB	Clamp Type:	1200A			
Total Size:	1946 MB	RS232 Out Sel:				
PT:	1 : 1	V1	I1	P1		
CT:	1 : 1	S1	Q1	PF1		
Beep:	ON	Φ1	WH	FREQ		
Year	Month	Date	Hour	Minute	Second	
2008	12	05	11	16	01	

#### 4.5.4 Delete a file on the SD Memory Card

1. Press and hold the SHIFT KEY for at least 2 seconds and the indicator " Y or N " will appear on the right side of the display
2. Press ▲ and the display will show " Y " in highlight, press the SETUP KEY again to confirm, the selected file (ex: 3P401001.XLS) will be erased and the meter will then return to screen 1 (Fig. 4-5-4a)
3. Press ▼ in screen 1 (Fig. 4-5-4a) to enter the next setting function (Delete File → SD Format)

Figure 4-5-4a: Delete File (Screen 1)

Folder Name:	WTA01					<b>SETUP</b>
File Name:	3P401001.XLS					<b>SHIFT 1</b>
REC Date:	2008-11-28 00:03:17					
Sampling Time:	2					
<b>Delete File:</b>	0 %					
SD Format:	0 %					
Use Size:	388 KB	Decimal:	Basic			
Free Size:	1946 MB	Clamp Type:	1200A			
Total Size:	1946 MB	RS232 Out Sel:				
PT:	1 : 1	V1	I1	P1		
CT:	1 : 1	S1	Q1	PF1		
Beep:	ON	Φ1	WH	FREQ		
Year	Month	Date	Hour	Minute	Second	
2008	12	05	11	16	20	

Figure 4-5-4b: Delete File (Screen 2)

Folder Name:	WTA01					<b>SETUP</b>
File Name:	3P401001.XLS					<b>SHIFT 1</b>
REC Date:	2008-11-28 00:03:17					
Sampling Time:	2					
<b>Delete File:</b>	Y OR N					
SD Format:	0 %					
Use Size:	388 KB	Decimal:	Basic			
Free Size:	1946 MB	Clamp Type:	1200A			
Total Size:	1946 MB	RS232 Out Sel:				
PT:	1 : 1	V1	I1	P1		
CT:	1 : 1	S1	Q1	PF1		
Beep:	ON	Φ1	WH	FREQ		
Year	Month	Date	Hour	Minute	Second	
2008	12	05	11	16	45	

#### 4.5.5 Formatting an SD Memory Card

1. Press and hold the SHIFT KEY for at least 2 seconds and the indicator " Y or N " will appear on the right side of the display, press ▲ and the display will show " Y " highlighted
2. Press SETUP again to confirm the formatting of the SD CARD
3. Press ▼ in screen 1(Fig.4-5-5a) to enter the next setting function (SD Format → PT)

Figure 4-5-5a: Format SD Card Screen 1

Folder Name:	WTA01					<b>SETUP</b>
File Name:	3P401001.XLS					<b>SHIFT 1</b>
REC Date:	2008-11-28 00:03:17					
Sampling Time:	2					
Delete File:	0 %					
<b>SD Format:</b>	0 %					
Use Size:	388 KB	Decimal:	Basic			
Free Size:	1946 MB	Clamp Type:	1200A			
Total Size:	1946 MB	RS232 Out Sel:				
PT:	1 : 1	V1	I1	P1		
CT:	1 : 1	S1	Q1	PF1		
Beep:	ON	Φ1	WH	FREQ		
Year	Month	Date	Hour	Minute	Second	
2008	12	05	11	17	05	

Figure 4-5-5: Format SD Card Screen 2

Folder Name:	WTA01					<b>SETUP</b>
File Name:	3P401001.XLS					<b>SHIFT 1</b>
REC Date:	2008-11-28 00:03:17					
Sampling Time:	2					
Delete File:	0 %					
<b>SD Format:</b>	Y OR N					
Use Size:	388 KB	Decimal:	Basic			
Free Size:	1946 MB	Clamp Type:	1200A			
Total Size:	1946 MB	RS232 Out Sel:				
PT:	1 : 1	V1	I1	P1		
CT:	1 : 1	S1	Q1	PF1		
Beep:	ON	Φ1	WH	FREQ		
Year	Month	Date	Hour	Minute	Second	
2008	12	05	11	17	20	

#### 4.5.6 Potential Transformer (PT) Setup

1. Press SHIFT once, and the symbol " SHIFT1 " will switch off; press ▲ or ▼ to adjust the PT value (the range is 1 to 1000)
2. Press SHIFT again to return to screen 1 (Fig. 4-5-6a) and then press ▼ to enter the next function (PT CT)

Figure 4-5-6a: PT Setup (Screen 1)

Folder Name:	WTA01					<b>SETUP</b>
File Name:	3P401001.XLS					<b>SHIFT 1</b>
REC Date:	2008-11-28 00:03:17					
Sampling Time:	2					
Delete File:	0 %					
SD Format:	0 %					
Use Size:	388 KB	Decimal:	Basic			
Free Size:	1946 MB	Clamp Type:	1200A			
Total Size:	1946 MB	RS232 Out Sel:				
<b>PT:</b>	1 : 1	V1	I1	P1		
CT:	1 : 1	S1	Q1	PF1		
Beep:	ON	Φ1	WH	FREQ		
Year	Month	Date	Hour	Minute	Second	
2008	12	05	11	17	53	

Figure 4-5-6b: PT Setup (Screen 2)

Folder Name:	WTA01					<b>SETUP</b>
File Name:	3P401001.XLS					
REC Date:	2008-11-28 00:03:17					
Sampling Time:	2					
Delete File:	0 %					
SD Format:	0 %					
Use Size:	388 KB	Decimal:	Basic			
Free Size:	1946 MB	Clamp Type:	1200A			
Total Size:	1946 MB	RS232 Out Sel:				
<b>PT:</b>	1 : 1	V1	I1	P1		
CT:	1 : 1	S1	Q1	PF1		
Beep:	ON	Φ1	WH	FREQ		
Year	Month	Date	Hour	Minute	Second	
2008	12	05	11	19	07	

#### 4.5.7 Current Transformer (CT) Setup

1. Press SHIFT once, and the symbol " SHIFT1 " will switch off; press ▲ or ▼ to adjust the CT value (the range is 1 to 600)
2. Press SHIFT again to return to screen 1 (Fig. 4-5-7a) then press ▼ to enter the next function (CT → BEEP)

Figure 4-5-7a: CT Setup (Screen 1)

Folder Name:	WTA01					<b>SETUP</b>
File Name:	3P401001.XLS					<b>SHIFT 1</b>
REC Date:	2008-11-28 00:03:17					
Sampling Time:	2					
Delete File:	0 %					
SD Format:	0 %					
Use Size:	388 KB	Decimal:	Basic			
Free Size:	1946 MB	Clamp Type:	1200A			
Total Size:	1946 MB	RS232 Out Sel:				
PT:	1 : 1	V1	I1	P1		
<b>CT:</b>	1 : 1	S1	Q1	PF1		
Beep:	ON	Φ1	WH	FREQ		
Year	Month	Date	Hour	Minute	Second	
2008	12	05	11	19	20	

Figure 4-5-7b: CT Setup (Screen 2)

Folder Name:	WTA01					<b>SETUP</b>
File Name:	3P401001.XLS					
REC Date:	2008-11-28 00:03:17					
Sampling Time:	2					
Delete File:	0 %					
SD Format:	0 %					
Use Size:	388 KB	Decimal:	Basic			
Free Size:	1946 MB	Clamp Type:	1200A			
Total Size:	1946 MB	RS232 Out Sel:				
PT:	1 : 1	V1	I1	P1		
<b>CT:</b>	1 : 1	S1	Q1	PF1		
Beep:	ON	Φ1	WH	FREQ		
Year	Month	Date	Hour	Minute	Second	
2008	12	05	11	19	30	

#### 4.5.8 Audible Beeper ON/OFF

1. Press SHIFT once and the symbol " SHIFT1 " will switch off; press ▲ or ▼ to turn the beeper ON/OFF
2. Press SHIFT again to return to screen 1 (Fig. 4-5-8a) and then press ▼ to enter the next function (BEEPER → Decimal type)

Figure 4-5-8a: Beeper (Screen 1)

Folder Name:	WTA01					<b>SETUP</b>
File Name:	3P401001.XLS					<b>SHIFT 1</b>
REC Date:	2008-11-28 00:03:17					
Sampling Time:	2					
Delete File:	0 %					
SD Format:	0 %					
Use Size:	388 KB	Decimal:	Basic			
Free Size:	1946 MB	Clamp Type:	1200A			
Total Size:	1946 MB	RS232 Out Sel:				
PT:	1 : 1	V1	I1	P1		
CT:	1 : 1	S1	Q1	PF1		
<b>Beeper:</b>	ON	Φ1	WH	FREQ		
Year	Month	Date	Hour	Minute	Second	
2008	12	05	11	19	44	

Figure 4-5-8b: Beeper (Screen 2)

Folder Name:	WTA01					<b>SETUP</b>
File Name:	3P401001.XLS					
REC Date:	2008-11-28 00:03:17					
Sampling Time:	2					
Delete File:	0 %					
SD Format:	0 %					
Use Size:	388 KB	Decimal:	Basic			
Free Size:	1946 MB	Clamp Type:	1200A			
Total Size:	1946 MB	RS232 Out Sel:				
PT:	1 : 1	V1	I1	P1		
CT:	1 : 1	S1	Q1	PF1		
<b>Beeper:</b>	ON	Φ1	WH	FREQ		
Year	Month	Date	Hour	Minute	Second	
2008	12	05	11	19	58	

#### 4.5.9 Decimal Format (Basic or European)

Note: SD Memory Cards default to basic decimal format that uses a period, for example: 20.00. European format uses a comma, for example: 20,00

1. Press SHIFT once and the symbol " SHIFT1 " will switch off; press ▲ or ▼ to select decimal format (BASIC or EURO)
2. Press SHIFT again to return to screen 1 and then press ▼ to enter the next function (Decimal type → Clamp type)

Figure 4-5-9a: Decimal (Screen 1)

Folder Name:	WTA01					<b>SETUP</b>
File Name:	3P401001.XLS					<b>SHIFT 1</b>
REC Date:	2008-11-28 00:03:17					
Sampling Time:	2					
Delete File:	0 %					
SD Format:	0 %					
Use Size:	388 KB	<b>Decimal :</b>	Basic			
Free Size:	1946 MB	Clamp Type:	1200A			
Total Size:	1946 MB	RS232 Out Sel:				
PT:	1 : 1	V1	I1	P1		
CT:	1 : 1	S1	Q1	PF1		
Beep:	ON	Φ1	WH	FREQ		
Year	Month	Date	Hour	Minute	Second	
2008	12	05	11	20	18	

Figure 4-5-9b: Decimal (Screen 2)

Folder Name:	WTA01					<b>SETUP</b>
File Name:	3P401001.XLS					
REC Date:	2008-11-28 00:03:17					
Sampling Time:	2					
Delete File:	0 %					
SD Format:	0 %					
Use Size:	388 KB	<b>Decimal :</b>	Basic			
Free Size:	1946 MB	Clamp Type:	1200A			
Total Size:	1946 MB	RS232 Out Sel:				
PT:	1 : 1	V1	I1	P1		
CT:	1 : 1	S1	Q1	PF1		
Beep:	ON	Φ1	WH	FREQ		
Year	Month	Date	Hour	Minute	Second	
2008	12	05	11	20	18	

#### 4.5.10 Set Clamp type to 200 A or 1200 A

1. Press SHIFT once and the symbol " SHIFT1 " will switch off; press ▲ or ▼ to select the clamp type
2. Press SHIFT again to return to screen 1 (Fig. 4-5-10a) and then press ▼ to enter the next function (Clamp type → RS232 Output Select)

Figure 4-5-10a: Clamp Type (Screen 1)

Folder Name:	WTA01					<b>SETUP</b>
File Name:	3P401001.XLS					<b>SHIFT 1</b>
REC Date:	2008-11-28 00:03:17					
Sampling Time:	2					
Delete File:	0 %					
SD Format:	0 %					
Use Size:	388	KB	Decimal:	Basic		
Free Size:	1946	MB	<b>Clamp Type:</b>	1200A		
Total Size:	1946	MB	RS232 Out Sel:			
PT:	1 : 1	V1	I1	P1		
CT:	1 : 1	S1	Q1	PF1		
Beep:	ON	Φ1	WH	FREQ		
Year	Month	Date	Hour	Minute	Second	
2008	12	05	11	20	18	

Figure 4-5-10b: Clamp Type (Screen 2)

Folder Name:	WTA01					<b>SETUP</b>
File Name:	3P401001.XLS					
REC Date:	2008-11-28 00:03:17					
Sampling Time:	2					
Delete File:	0 %					
SD Format:	0 %					
Use Size:	388	KB	Decimal:	Basic		
Free Size:	1946	MB	<b>Clamp Type:</b>	1200A		
Total Size:	1946	MB	RS232 Out Sel:			
PT:	1 : 1	V1	I1	P1		
CT:	1 : 1	S1	Q1	PF1		
Beep:	ON	Φ1	WH	FREQ		
Year	Month	Date	Hour	Minute	Second	
2008	12	05	11	19	44	

#### 4.5.11 Set RS-232 Output Parameters

1. Press and hold the SHIFT KEY for at least two seconds and use ▲ or ▼ to select the items to output (nine items max.).
2. When the cursor is on the selected item, press SHIFT again and the selected item will be displayed highlighted
3. If more than nine items are selected the display will show the indicator " full "
4. After the selection process is complete, press and hold SHIFT for at least two seconds to return to screen 1 (Fig. 4-5-11a) and display all of the selected items
5. Press ▼ in screen 1 to enter the next setting function (RS232 Out Sel → Year)

Figure 4-5-11a: RS232 Output (Screen 1)

RS232 OUTPUT SELECT		
1. V12	12. P3	23. PF2
2. V23	13. PΣ	24. PF3
3. V31	14. <b>S1</b>	25. PFΣ
<b>4.</b> V1	15. S2	26. PFH
5. V2	16. S3	27. <b>Φ 1</b>
6. V3	17. SΣ	28. Φ 2
7. <b>I1</b>	18. <b>Q1</b>	29. Φ 3
8. I2	19. Q2	30. <b>WH</b>
9. I3	20. Q3	31. SH
10. <b>P1</b>	21. QΣ	32. OH
11. P2	22. <b>PF1</b>	33. <b>FREQ</b>

Figure 4-5-11b: RS232 Output (Screen 2)

RS232 OUTPUT SELECT		
1. V12	12. P3	23. PF2
2. V23	13. PΣ	24. PF3
3. V31	14. <b>S1</b>	25. PFΣ
<b>4.</b> <b>V1</b>	15. S2	26. PFH
5. V2	16. S3	27. <b>Φ 1</b>
6. V3	17. SΣ	28. Φ 2
7. I1	18. <b>Q1</b>	29. Φ 3
8. I2	19. Q2	30. <b>WH</b>
9. I3	20. Q3	31. SH
10. <b>P1</b>	21. QΣ	32. OH
11. P2	22. <b>PF1</b>	33. <b>FREQ</b>
<b>FULL</b>		

#### 4.5.12 Set Time and Date

1. Press SHIFT once and the symbol " SHIFT1" will switch off; Use ▲ or ▼ to set the parameters (press and hold ▲ or ▼ for at least two seconds to scroll quickly)
2. Press ▼ in screen 1 to enter the next setup function (Year -> Month)
3. The settings (Month -> Date), (Date -> Hour), (Hour -> Minute), (Minute -> Second) are configured by the same method as described above in steps 1 and 2

Figure 4-5-12a: Date and Time (Screen 1)

Folder Name:	WTA01					<b>SETUP</b>
File Name:	3P401001.XLS					<b>SHIFT 1</b>
REC Date:	2008-11-28 00:03:17					
Sampling Time:	2					
Delete File:	0 %					
SD Format:	0 %					
Use Size:	388 KB	Decimal:	Basic			
Free Size:	1946 MB	Clamp Type:	1200A			
Total Size:	1946 MB	RS232 Out Sel:				
PT:	1 : 1	V1	I1	P1		
CT:	1 : 1	S1	Q1	PF1		
Beep:	ON	Φ 1	WH	FREQ		
<b>Year</b>	Month	Date	Hour	Minute	Second	
2008	12	05	12	02	13	

Figure 4-5-12b: Date and Time (Screen 2)

Folder Name:	WTA01					<b>SETUP</b>
File Name:	3P401001.XLS					
REC Date:	2008-11-28 00:03:17					
Sampling Time:	2					
Delete File:	0 %					
SD Format:	0 %					
Use Size:	388 KB	Decimal:	Basic			
Free Size:	1946 MB	Clamp Type:	1200A			
Total Size:	1946 MB	RS232 Out Sel:				
PT:	1 : 1	V1	I1	P1		
CT:	1 : 1	S1	Q1	PF1		
Beep:	ON	Φ 1	WH	FREQ		
<b>Year</b>	Month	Date	Hour	Minute	Second	
2008	12	05	12	02	28	

#### 4.5.13 Exit the Setup Mode

When all of the programming has been completed, press the EXIT key to return to the measurement screen

#### 4.5.14 SD Memory Card definitions

- USE: Memory space that has been filled
- FREE SIZE: Amount of free memory space
- TOTAL SIZE: Maximum memory size of card

Note that SD and SDHC cards can be used

#### 4.5.15 RESET Key

Press the RESET key to reboot the instrument.

## 5.0 Measurement Instructions

### 5.1 1 $\Phi$ 2W (Single Phase - Two Wire) Measurement

#### 1 $\Phi$ 2W

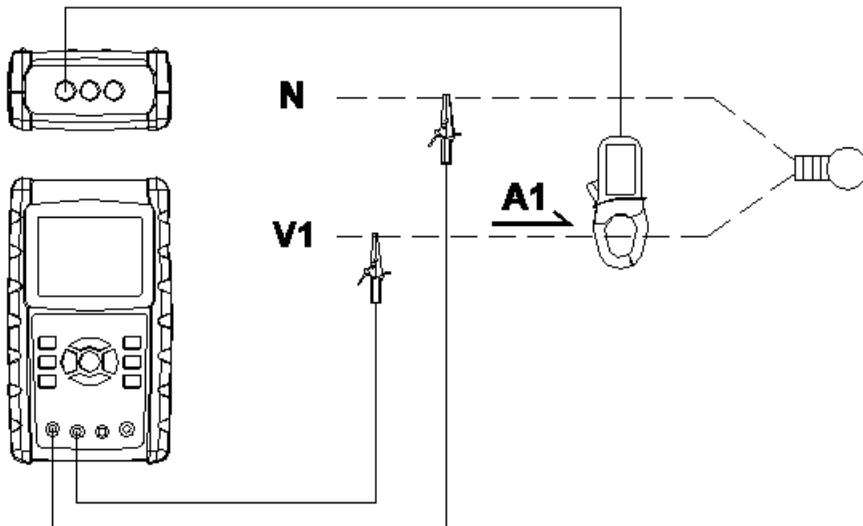

1. Power the instrument ON by pressing the POWER KEY, and then press 1 $\Phi$  3 $\Phi$  KEY to select the 1 $\Phi$  2W system, the selected name of the system will be shown on the bottom left side of the display on screen 2
2. Connect the line voltage L1, Vn (Neutral) to V1 and N terminals of the instrument.
3. Connect the Clamp (A1) to the conductor (A1)
4. Connect Clamp 1 (A1) to the A1 terminal of the instrument
5. The related measurement factors will appear on the display
6. Measurement definitions can be found in Appendix 1 (5-11)

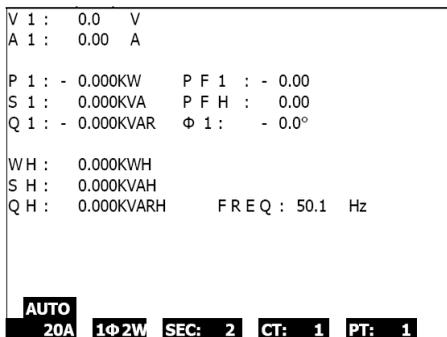
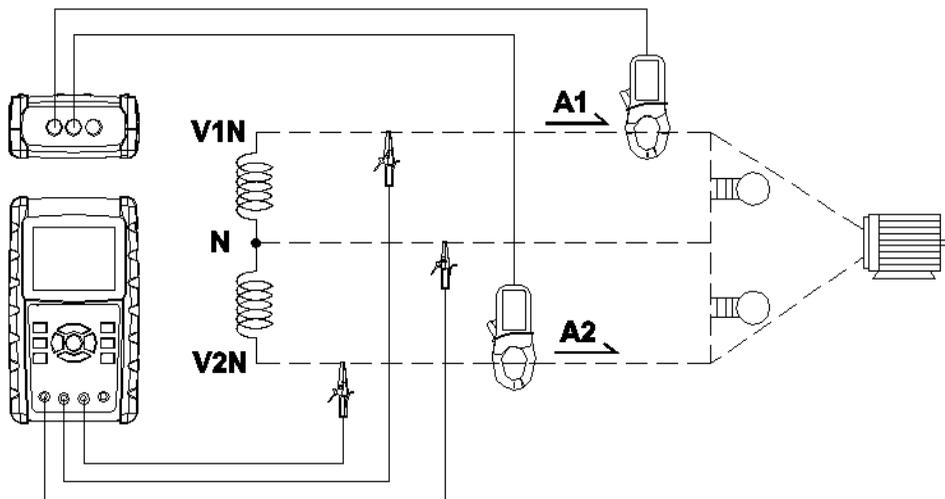

Fig. 5-1

## 5.2 1Φ3W (single phase - three wire) Measurement

### 1Φ3W



1. Power the instrument ON by pressing POWER KEY, and then press the 1Φ 3Φ KEY to select 1Φ 3W, the selected name of the configuration will appear on bottom left hand side of the display for screen 2.
2. Connect the line voltage L1, L2 and Vn (Neutral) to V1, V2 and N terminals of the instrument
3. Connect the two (2) clamps (A1 and A2) to the conductors (A1) and (A2)
4. Connect Clamp 1 and Clamp 2 (A1 and A2) to the A1 and A2 terminals of the instrument
5. The related measurement factors will appear on the display
6. Measurement definitions can be found in Appendix 1 (5-11)

V 1 :	0.0	V	P 1 :	-	0.000KW
V 2 :	0.0	V	P 2 :	-	0.000KW
A 1 :	0.00	A	S 1 :	0.000KVA	
A 2 :	0.00	A	S 2 :	0.000KVA	
Q 1 :	-	0.000KVAR			
Q 2 :	-	0.000KVAR			
<b>PΣ :</b>	0.000	KW	<b>SΣ :</b>	0.000	KVA
<b>PF1:</b>	-	0.00	<b>PF2:</b>	-	0.00
<b>PFH:</b>	0.00		<b>Φ1:</b>	-	0.0°
<b>QΣ :</b>	0.000	KVAR	<b>Φ2:</b>	-	0.0°
<b>WH:</b>	0.000	KWH	<b>SH:</b>	0.000	KVAH
<b>QH:</b>	0.000	KVARH	<b>FREQ:</b>	50.0	Hz
<b>AUTO</b>					
<b>20A</b>	<b>1Φ3W</b>	<b>SEC: 2</b>	<b>CT: 1</b>	<b>PT: 1</b>	

Fig. 5-2

### 5.3 3Φ 3W (three phase - three wire) Measurement

#### 3Φ3W

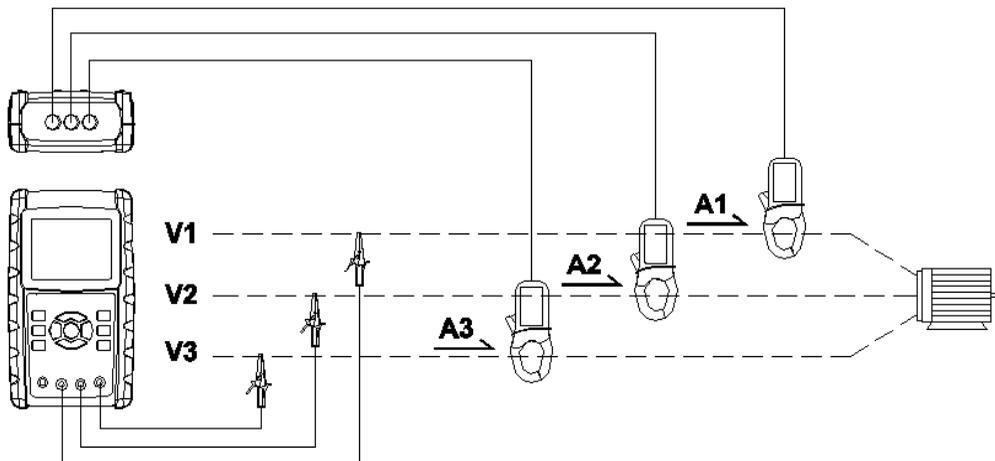

1. Power the instrument ON by pressing the POWER KEY, and then press 1Φ 3Φ KEY to select 3Φ 3W, the selected configuration name will appear on bottom left hand side of the display for screen 2.
2. Connect the line voltage L1, L2 and L3 to V1, V2 and V3 terminals of the instrument.
3. Connect the three (3) clamps (A1, A2, A3) to A1, A2, A3
4. Connect the three (3) Clamps to the meter using the A1, A2, and A3 terminals
5. The related measurement factors will appear on the display
6. Measurement definitions can be found in Appendix 1 (5-11)

V 1 2 :	0.0	V	A 1 :	0.00	A
V 2 3 :	0.0	V	A 2 :	0.00	A
V 3 1 :	0.0	V	A 3 :	0.00	A
P Σ :	- 0.000	KW			
S Σ :	0.000	KVA			
Q Σ :	0.000	KVAR			
PFΣ :	0.00		P F H :	0.00	
<b>WH:</b>	0.000	KWH	<b>SH:</b>	0.000	KVAH
<b>QH:</b>	0.000	KVARH	<b>FREQ:</b>	50.0	Hz
<b>AUTO</b>					
<b>20A</b>	<b>3Φ3W</b>		<b>SEC: 2</b>	<b>CT: 1</b>	<b>PT: 1</b>

Fig. 5-3

## 5.4 3Φ 4W (three phase - four wire) Measurement

### 3Φ4W

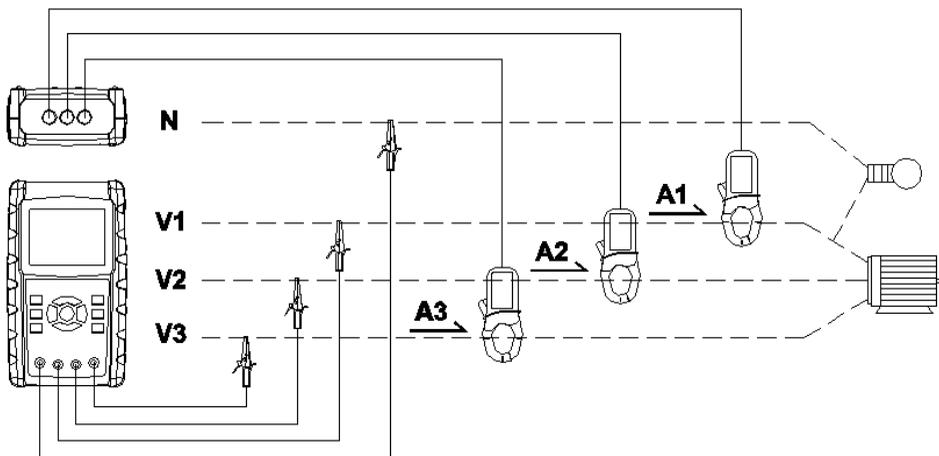

1. Power the instrument ON by pressing the POWER KEY, and then press 1Φ 3Φ KEY to select the 3Φ 4W system, the selected name of the system will appear on the bottom left hand side of the display for screen 2
2. Connect the line voltage L1, L2, L3 and Vn to V1, V2, V3 and N terminals of the instrument
3. Connect the three (3) Clamps (A1, A2, A3) to the conductors A1, A2, A3
4. Connect the Clamps (A1, A2, A3) to the meter's A1, A2, A3 terminals
5. The related measurement factors will appear on the display
6. Measurement definitions can be found in Appendix 1 (5-11)

<b>V12:</b> 0.0 V	<b>V1:</b> 0.0 V	<b>A1:</b> 0.00 A
<b>V23:</b> 0.0 V	<b>V2:</b> 0.0 V	<b>A2:</b> 0.00 A
<b>V31:</b> 0.0 V	<b>V3:</b> 0.0 V	<b>A3:</b> 0.00 A
<b>P1:</b> - 0.000 KW	<b>S1:</b> 0.000 KVA	<b>Q1:</b> - 0.000 KVAR
<b>P2:</b> - 0.000 KW	<b>S2:</b> 0.000 KVA	<b>Q2:</b> - 0.000 KVAR
<b>P3:</b> - 0.000 KW	<b>S3:</b> 0.000 KVA	<b>Q3:</b> - 0.000 KVAR
<b>PΣ</b> - 0.000 KW	<b>SΣ</b> : 0.000 KVA	<b>QΣ</b> : - 0.000 KVAR
<b>PF1:</b> - 0.00	<b>PF2:</b> - 0.00	<b>PF3:</b> - 0.00
<b>PF2</b> : 0.00	<b>PFH:</b> 0.00	
<b>Φ 1:</b> - 0.0°	<b>Φ 2:</b> - 0.0°	<b>Φ 3:</b> - 0.0°
<b>WH:</b> 0.000 KWH	<b>SH:</b> 0.000 KVAH	
<b>QH:</b> 0.000 KVARH	<b>FREQ:</b> 0.0 Hz	
<b>AUTO</b>		
<b>20A</b>	<b>3Φ4W</b>	<b>SEC: 2</b>
		<b>CT: 1</b>
		<b>PT: 1</b>

Fig. 5-4

## 5.5 Current (CT) / Potential (PT) Transformer Measurement

### CT . PT

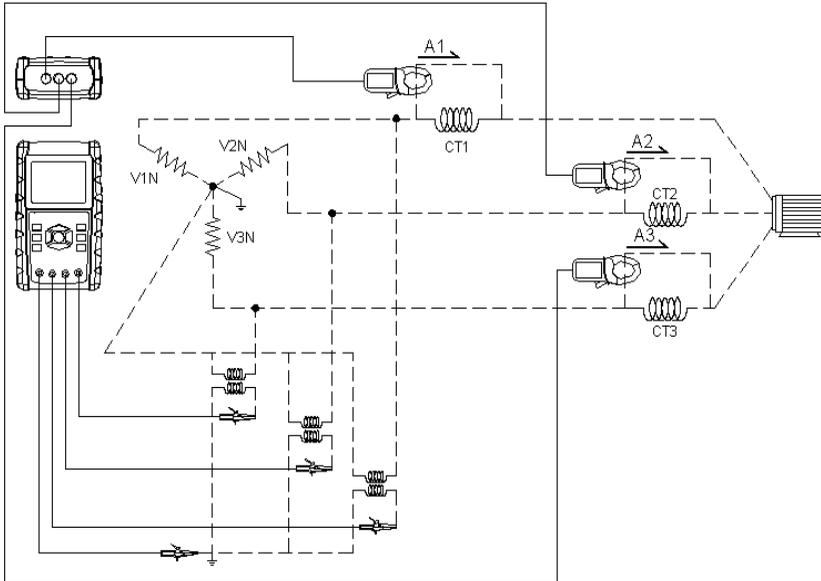

1. Power the instrument ON by pressing the POWER KEY, and then press the 1Φ 3Φ KEY to select the 3Φ 4W system, the selected name of the system will appear on the bottom left hand side of the display for screen 2
2. Connect the line voltage L1, L2, L3 and Vn to the V1, V2, V3 and N terminals of the instrument
3. Connect the three (3) Clamps (A1, A2, A3) to the conductors A1, A2, A3
4. Connect the Clamps (A1, A2, A3) to the meter's A1, A2, A3 terminals
5. The related measurement factors will appear on the display
6. Measurement definitions can be found in Appendix 1 (5-11)

<b>V12:</b> 0.0 V	<b>V1:</b> 0.0 V	<b>A1:</b> 0.00 A
<b>V23:</b> 0.0 V	<b>V2:</b> 0.0 V	<b>A2:</b> 0.00 A
<b>V31:</b> 0.0 V	<b>V3:</b> 0.0 V	<b>A3:</b> 0.00 A
<b>P1:</b> - 0.000 KW	<b>S1:</b> 0.000 KVA	<b>Q1:</b> - 0.000 KVAR
<b>P2:</b> - 0.000 KW	<b>S2:</b> 0.000 KVA	<b>Q2:</b> - 0.000 KVAR
<b>P3:</b> - 0.000 KW	<b>S3:</b> 0.000 KVA	<b>Q3:</b> - 0.000 KVAR
<b>PΣ</b> - 0.000 KW	<b>SΣ</b> : 0.000 KVA	<b>QΣ</b> : - 0.000 KVAR
<b>PF1:</b> - 0.00	<b>PF2:</b> - 0.00	<b>PF3:</b> - 0.00
<b>PFΣ</b> : 0.00	<b>PFH:</b> 0.00	
<b>Φ 1:</b> - 0.0°	<b>Φ 2:</b> - 0.0°	<b>Φ 3:</b> - 0.0°
<b>WH:</b> 0.000 KWH	<b>SH:</b> 0.000 KVAH	
<b>QH:</b> 0.000 KVARH	<b>FREQ:</b> 0.0 Hz	
<b>AUTO</b>		
<b>20A</b>	<b>3Φ4W</b>	<b>SEC: 2</b>
		<b>CT: 1</b>
		<b>PT: 1</b>

Fig. 5-5

## 5.6 – Datalogger Function

1. Press the REC KEY once to begin
2. If the meter display shows " Change Card " at the bottom right, either the SD CARD memory is full or the SD CARD is damaged
3. If the SD CARD is functional and it has available space datalogging will begin

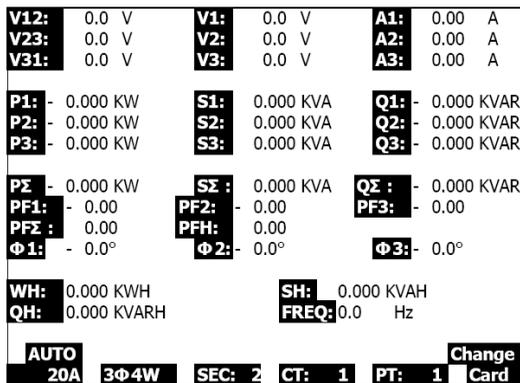

Fig.5-6a

4. The display will show the recorded data points on the bottom right side of screen
5. Each file can store up to 30,000 data points. When the number of data points reaches 30,000 the system will create a new file automatically. (For example, WTA01001.XLS will be replaced by WTA01002.XLS)
6. Press the REC KEY twice to stop datalogging
7. Instructions are provided elsewhere in this manual for exporting the stored data to a spreadsheet on a PC

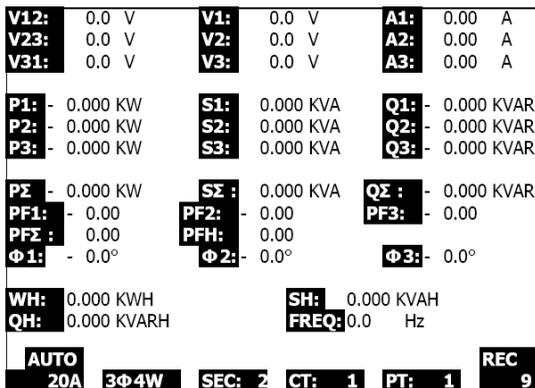

Fig. 5-6b

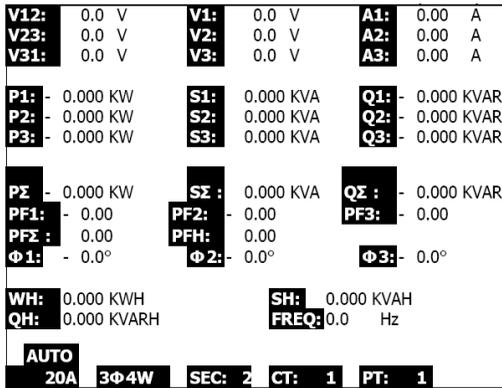

Fig. 5-6c

## 5.7 – Data Hold Function

1. During a measurement, press the HOLD KEY once, the display will show “HOLD” on the bottom right side of the screen
2. Press the HOLD KEY twice to disable the Data HOLD function; the “HOLD” display will switch off

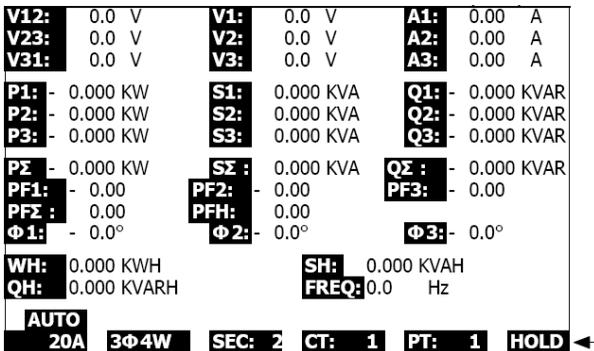

Fig. 5-7a

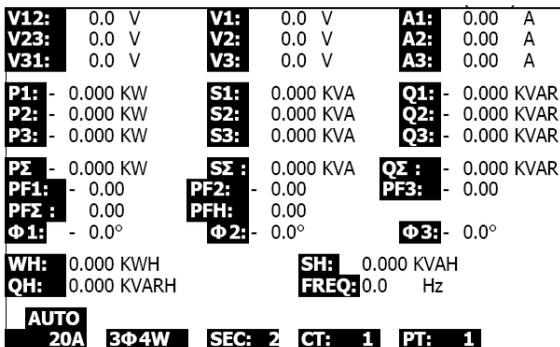

Fig. 5-7b

## 5.8 – LCD Backlight Key

Press to turn the backlight ON or OFF. Note: Use of the backlight will place a higher burden on battery power.

## 5.9 – Current (A) RANGE Key (AUTO / MANUAL RANGE)

1. Use the A RANGE KEY to step through the available display ranges
2. Press and hold the A RANGE KEY for at least for 2 seconds to change from MANUAL RANGE to AUTO RANGE

<b>V12:</b> 0.0 V	<b>V1:</b> 0.0 V	<b>A1:</b> 0.00 A
<b>V23:</b> 0.0 V	<b>V2:</b> 0.0 V	<b>A2:</b> 0.00 A
<b>V31:</b> 0.0 V	<b>V3:</b> 0.0 V	<b>A3:</b> 0.00 A
<b>P1:</b> - 0.000 KW	<b>S1:</b> 0.000 KVA	<b>Q1:</b> - 0.000 KVAR
<b>P2:</b> - 0.000 KW	<b>S2:</b> 0.000 KVA	<b>Q2:</b> - 0.000 KVAR
<b>P3:</b> - 0.000 KW	<b>S3:</b> 0.000 KVA	<b>Q3:</b> - 0.000 KVAR
<b>PΣ</b> - 0.000 KW	<b>SΣ</b> : 0.000 KVA	<b>QΣ</b> : - 0.000 KVAR
<b>PF1:</b> - 0.00	<b>PF2:</b> - 0.00	<b>PF3:</b> - 0.00
<b>PFΣ</b> : 0.00	<b>PFH:</b> 0.00	
<b>Φ 1:</b> - 0.0°	<b>Φ 2:</b> - 0.0°	<b>Φ 3:</b> - 0.0°
<b>WH:</b> 0.000 KWH	<b>SH:</b> 0.000 KVAH	
<b>QH:</b> 0.000 KVARH	<b>FREQ:</b> 0.0 Hz	
<b>MANU</b>		
<b>200A</b>	<b>3Φ4W</b>	<b>SEC: 2 CT: 1 PT: 1</b>

Fig. 5-9a

<b>V12:</b> 0.0 V	<b>V1:</b> 0.0 V	<b>A1:</b> 0.00 A
<b>V23:</b> 0.0 V	<b>V2:</b> 0.0 V	<b>A2:</b> 0.00 A
<b>V31:</b> 0.0 V	<b>V3:</b> 0.0 V	<b>A3:</b> 0.00 A
<b>P1:</b> - 0.000 KW	<b>S1:</b> 0.000 KVA	<b>Q1:</b> - 0.000 KVAR
<b>P2:</b> - 0.000 KW	<b>S2:</b> 0.000 KVA	<b>Q2:</b> - 0.000 KVAR
<b>P3:</b> - 0.000 KW	<b>S3:</b> 0.000 KVA	<b>Q3:</b> - 0.000 KVAR
<b>PΣ</b> - 0.000 KW	<b>SΣ</b> : 0.000 KVA	<b>QΣ</b> : - 0.000 KVAR
<b>PF1:</b> - 0.00	<b>PF2:</b> - 0.00	<b>PF3:</b> - 0.00
<b>PFΣ</b> : 0.00	<b>PFH:</b> 0.00	
<b>Φ 1:</b> - 0.0°	<b>Φ 2:</b> - 0.0°	<b>Φ 3:</b> - 0.0°
<b>WH:</b> 0.000 KWH	<b>SH:</b> 0.000 KVAH	
<b>QH:</b> 0.000 KVARH	<b>FREQ:</b> 0.0 Hz	
<b>MANU</b>		
<b>1200A</b>	<b>3Φ4W</b>	<b>SEC: 2 CT: 1 PT: 1</b>

Fig. 5-9b

<b>V12:</b> 0.0 V	<b>V1:</b> 0.0 V	<b>A1:</b> 0.00 A
<b>V23:</b> 0.0 V	<b>V2:</b> 0.0 V	<b>A2:</b> 0.00 A
<b>V31:</b> 0.0 V	<b>V3:</b> 0.0 V	<b>A3:</b> 0.00 A
<b>P1:</b> - 0.000 KW	<b>S1:</b> 0.000 KVA	<b>Q1:</b> - 0.000 KVAR
<b>P2:</b> - 0.000 KW	<b>S2:</b> 0.000 KVA	<b>Q2:</b> - 0.000 KVAR
<b>P3:</b> - 0.000 KW	<b>S3:</b> 0.000 KVA	<b>Q3:</b> - 0.000 KVAR
<b>PΣ</b> - 0.000 KW	<b>SΣ</b> : 0.000 KVA	<b>QΣ</b> : - 0.000 KVAR
<b>PF1:</b> - 0.00	<b>PF2:</b> - 0.00	<b>PF3:</b> - 0.00
<b>PFΣ</b> : 0.00	<b>PFH:</b> 0.00	
<b>Φ1:</b> - 0.0°	<b>Φ2:</b> 0.0°	<b>Φ3:</b> 0.0°
<b>WH:</b> 0.000 KWH	<b>SH:</b> 0.000 KVAH	
<b>QH:</b> 0.000 KVARH	<b>FREQ:</b> 0.0 Hz	
<b>MANU</b>		
<b>20A</b>	<b>3Φ4W</b>	<b>SEC: 2 CT: 1 PT: 1</b>

Fig. 5-9c

<b>V12:</b> 0.0 V	<b>V1:</b> 0.0 V	<b>A1:</b> 0.00 A
<b>V23:</b> 0.0 V	<b>V2:</b> 0.0 V	<b>A2:</b> 0.00 A
<b>V31:</b> 0.0 V	<b>V3:</b> 0.0 V	<b>A3:</b> 0.00 A
<b>P1:</b> - 0.000 KW	<b>S1:</b> 0.000 KVA	<b>Q1:</b> - 0.000 KVAR
<b>P2:</b> - 0.000 KW	<b>S2:</b> 0.000 KVA	<b>Q2:</b> - 0.000 KVAR
<b>P3:</b> - 0.000 KW	<b>S3:</b> 0.000 KVA	<b>Q3:</b> - 0.000 KVAR
<b>PΣ</b> - 0.000 KW	<b>SΣ</b> : 0.000 KVA	<b>QΣ</b> : - 0.000 KVAR
<b>PF1:</b> - 0.00	<b>PF2:</b> - 0.00	<b>PF3:</b> - 0.00
<b>PFΣ</b> : 0.00	<b>PFH:</b> 0.00	
<b>Φ1:</b> - 0.0°	<b>Φ2:</b> 0.0°	<b>Φ3:</b> 0.0°
<b>WH:</b> 0.000 KWH	<b>SH:</b> 0.000 KVAH	
<b>QH:</b> 0.000 KVARH	<b>FREQ:</b> 0.0 Hz	
<b>AUTO</b>		
<b>20A</b>	<b>3Φ4W</b>	<b>SEC: 2 CT: 1 PT: 1</b>

Fig. 5-9d

## 5.10 – Low Battery Indication (LOW BAT)

When the LOW BAT indicator appears, replace the batteries as described in the Battery Replacement section of this manual. Use of weak batteries will compromise measurement accuracy and meter performance.

<b>V12:</b> 0.0 V	<b>V1:</b> 0.0 V	<b>A1:</b> 0.00 A
<b>V23:</b> 0.0 V	<b>V2:</b> 0.0 V	<b>A2:</b> 0.00 A
<b>V31:</b> 0.0 V	<b>V3:</b> 0.0 V	<b>A3:</b> 0.00 A
<b>P1:</b> - 0.000 KW	<b>S1:</b> 0.000 KVA	<b>Q1:</b> - 0.000 KVAR
<b>P2:</b> - 0.000 KW	<b>S2:</b> 0.000 KVA	<b>Q2:</b> - 0.000 KVAR
<b>P3:</b> - 0.000 KW	<b>S3:</b> 0.000 KVA	<b>Q3:</b> - 0.000 KVAR
<b>PΣ</b> - 0.000 KW	<b>SΣ</b> : 0.000 KVA	<b>QΣ</b> : - 0.000 KVAR
<b>PF1:</b> - 0.00	<b>PF2:</b> - 0.00	<b>PF3:</b> - 0.00
<b>PFΣ</b> : 0.00	<b>PFH:</b> 0.00	
<b>Φ1:</b> - 0.0°	<b>Φ2:</b> 0.0°	<b>Φ3:</b> 0.0°
<b>WH:</b> 0.000 KWH	<b>SH:</b> 0.000 KVAH	
<b>QH:</b> 0.000 KVARH	<b>FREQ:</b> 0.0 Hz	
<b>AUTO</b>		
<b>20A</b>	<b>3Φ4W</b>	<b>SEC: 2 CT: 1</b>
		<b>LOWBAT</b>
		<b>PT: 1</b>

## 5.10 – Appendix – Measurement Definitions

- V12, V23, V31 : Line Voltage
- V1, V2, V3 : Phase Voltage
- A1, A2, A3 : Line Current
- P1, P2, P3 : True Power of each phase (W)
- S1, S2, S3 : Apparent Power of each phase. (VA)
- Q1, Q2, Q3 : Reactive Power of each phase (VAR)
- PX : Total True Power (W)
- SX : Total Apparent Power (VA)
- QX : Total Reactive Power (VAR)
- PF1, PF2, PF3 : Power Factor of each phase
- PEX : Total Power Factor
- PFH : Long Term Average Power Factor ( WH/SH )
- CD 1, CD 2, CD 3 : Phase Angle of each phase
- WH : Watt Hour
- SH : Apparent Power Hour
- QH : Reactive Power Hour
- 1CD 2W : One phase by two wires
- 1CD 3W : One phase by three wires
- 3CD 3W : Three phases by three wires
- 3CD 4W : Three phases by four wires
- SEC : The sampling time of data logger
- CT : Current transformer
- PT : Potential transformer

## 6.0 Maintenance

---



CAUTION: Remove test leads before opening the battery cover; Electrical Shock Hazard.

### 6.1 Cleaning



CAUTION: When cleaning, use only a dry cloth. Do not use liquids of any kind to clean the meter.

### 6.2 Battery Replacement

1. When the display shows the " LOWBAT " indicator ( ref. 5-10), replace the batteries as soon as possible
2. Open the Battery Cover (3-19, Fig. 1) and remove the batteries
3. Replace the eight (8) batteries (1.5Vdc 'AA' batteries) and close the battery cover

You, as the end user, are legally bound (**Battery ordinance**) to return all used batteries and accumulators; **disposal in the household garbage is prohibited!**



You can hand over your used batteries / accumulators at collection points in your community or wherever batteries / accumulators are sold!

**Disposal:** Follow the valid legal stipulations in respect of the disposal of the device at the end of its lifecycle

## 7.0 PC Interface

### 7.1 RS-232 Serial PC Interface Protocol

The meter is equipped with a 3.5mm diameter phone jack (3-16, Fig. 1) for PC interface purposes. The output is a 16 digit data stream. The 16 digit data stream is configured as follows:

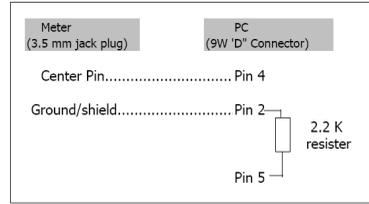

#### D15 D14 D13 D12 D11 D10 D9 D8 D7 D6 D5 D4 D3 D2 D1 D0

D15	Start Word		
D14	4		
D13	1 CH = 1	2 CH = 1 to 2	3 CH = 1 to 3
	4 CH = 1 to 4	5 CH = 1 to 5	6 CH = 1 to 6
	7 CH = 1 to 7	8 CH = 1 to 8	9 CH = 1 to 9
D12 & D11	Annunciator for Display		
	31=HZ	C0 = MW	D1 = GW/Hr
	32=DEGREE	C1 = GW	D2 = TW/Hr
	48=K WATT	C2 = TW	D3 = KVA/Hr
	50=ACV	C3 = MVA	D4 = MVA/Hr
	52=ACA	C4 = GVA	D5 = GVA/Hr
	64=KVA	C5 = TVA	D6 = TVA/Hr
	65=KW/HR	C6 = KVAR	D7 = KVAR/Hr
	B6 = KACV	C7 = MVAR	D8 = MVAR/Hr
	B7 = MACV	C8 = GVAR	D9 = GVAR/Hr
	B8 = KACA	C9 = TVAR	E0 = TVAR/Hr
B9 = MACA	D0 = MW/Hr	F9 = PF; G2 = PFH	
D10	Polarity (0 = Positive; 1 = Negative)		
D9	Decimal Point(DP), position from right to the left 0 = No DP, 1= 1 DP, 2 = 2 DP, 3 = 3 DP		
D8 to D1	Display reading, D1 = LSD, D8 = MSD For example : Display reading = 1234; D8 to D1 is : 00001234		
D0	End Word		

**RS232 settings:** Baud rate: 9600; Parity: None; Data Bits: 8; Stop bits: 1

## 7.2 Download SD Card Data to PC

1. After a Datalogging session, remove the SD card from the SD card socket (Section 3, item 3-15)
2. Plug the SD card into a PC SD card slot or into an SD card adapter
3. Power the computer and run spreadsheet software. Download the stored data file from the SD Card to the PC (file name examples: 3P401001.XLS, 1P201001.XLS, 1P301001.XLS, 3P301001.XLS)
4. The data files can be opened directly into a spreadsheet program

Example 1 – Data File opened in spreadsheet

	A	B	C	D	E	F	G	H	I	J	K	L
1	Position	Date	Time	V12	Unit	V23	Unit	V31	Unit	V1	Unit	V2
2	0	2009/1/4	08:58:53	0	ACV	0	ACV	0	ACV	0	ACV	0
3	0	2009/1/4	08:58:55	0	ACV	0	ACV	0	ACV	0	ACV	0
4	0	2009/1/4	08:58:57	0	ACV	0	ACV	0	ACV	0	ACV	0
5	0	2009/1/4	08:58:59	0	ACV	0	ACV	0	ACV	0	ACV	0
6	0	2009/1/4	08:59:01	0	ACV	0	ACV	0	ACV	0	ACV	0
7	0	2009/1/4	08:59:03	0	ACV	0	ACV	0	ACV	0	ACV	0
8	0	2009/1/4	08:59:05	0	ACV	0	ACV	0	ACV	0	ACV	0
9	0	2009/1/4	08:59:07	0	ACV	0	ACV	0	ACV	0	ACV	0
10	0	2009/1/4	08:59:09	0	ACV	0	ACV	0	ACV	0	ACV	0
11	0	2009/1/4	08:59:11	0	ACV	0	ACV	0	ACV	0	ACV	0
12												
13												

Example 2 – Data File opened in spreadsheet

	N	O	P	Q	R	S	T	U	V	W	X	Y
1	V3	Unit	A1	Unit	A2	Unit	A3	Unit	P1	Unit	P2	Unit
2	0	ACV	0	ACA	0	ACA	0	ACA	0	KW	0	KW
3	0	ACV	0	ACA	0	ACA	0	ACA	0	KW	0	KW
4	0	ACV	0	ACA	0	ACA	0	ACA	0	KW	0	KW
5	0	ACV	0	ACA	0	ACA	0	ACA	0	KW	0	KW
6	0	ACV	0	ACA	0	ACA	0	ACA	0	KW	0	KW
7	0	ACV	0	ACA	0	ACA	0	ACA	0	KW	0	KW
8	0	ACV	0	ACA	0	ACA	0	ACA	0	KW	0	KW
9	0	ACV	0	ACA	0	ACA	0	ACA	0	KW	0	KW
10	0	ACV	0	ACA	0	ACA	0	ACA	0	KW	0	KW
11	0	ACV	0	ACA	0	ACA	0	ACA	0	KW	0	KW
12												
13												

### Examples 3 and 4 – Data File opened in spreadsheet

	AA	AB	AC	AD	AE	AF	AG	AH	AI	AK	
1	P3	Unit	P(SUM)	Unit	S1	Unit	S2	Unit	S3	S(SUM)	Unit
2		0 KW	0 KW	0 KW	0 KVA	0 KVA	0 KVA	0 KVA	0 KVA	0 KVA	0 KVA
3		0 KW	0 KW	0 KW	0 KVA	0 KVA	0 KVA	0 KVA	0 KVA	0 KVA	0 KVA
4		0 KW	0 KW	0 KW	0 KVA	0 KVA	0 KVA	0 KVA	0 KVA	0 KVA	0 KVA
5		0 KW	0 KW	0 KW	0 KVA	0 KVA	0 KVA	0 KVA	0 KVA	0 KVA	0 KVA
6		0 KW	0 KW	0 KW	0 KVA	0 KVA	0 KVA	0 KVA	0 KVA	0 KVA	0 KVA
7		0 KW	0 KW	0 KW	0 KVA	0 KVA	0 KVA	0 KVA	0 KVA	0 KVA	0 KVA
8		0 KW	0 KW	0 KW	0 KVA	0 KVA	0 KVA	0 KVA	0 KVA	0 KVA	0 KVA
9		0 KW	0 KW	0 KW	0 KVA	0 KVA	0 KVA	0 KVA	0 KVA	0 KVA	0 KVA
10		0 KW	0 KW	0 KW	0 KVA	0 KVA	0 KVA	0 KVA	0 KVA	0 KVA	0 KVA
11		0 KW	0 KW	0 KW	0 KVA	0 KVA	0 KVA	0 KVA	0 KVA	0 KVA	0 KVA
12											
13											

	AL	AM	AN	AO	AP	AQ	AR	AS	AT	AU	AV	AW
1	Q.	Unit	Q2	Unit	Q3	Unit	Q(SUM)	Unit	PF	Unit	PF2	Unit
2		0 KVAR	0 KVAR	0 KVAR	0 KVAR	0 KVAR	0 KVAR	0	0	0	0	0
3		0 KVAR	0 KVAR	0 KVAR	0 KVAR	0 KVAR	0 KVAR	0	0	0	0	0
4		0 KVAR	0 KVAR	0 KVAR	0 KVAR	0 KVAR	0 KVAR	0	0	0	0	0
5		0 KVAR	0 KVAR	0 KVAR	0 KVAR	0 KVAR	0 KVAR	0	0	0	0	0
6		0 KVAR	0 KVAR	0 KVAR	0 KVAR	0 KVAR	0 KVAR	0	0	0	0	0
7		0 KVAR	0 KVAR	0 KVAR	0 KVAR	0 KVAR	0 KVAR	0	0	0	0	0
8		0 KVAR	0 KVAR	0 KVAR	0 KVAR	0 KVAR	0 KVAR	0	0	0	0	0
9		0 KVAR	0 KVAR	0 KVAR	0 KVAR	0 KVAR	0 KVAR	0	0	0	0	0
10		0 KVAR	0 KVAR	0 KVAR	0 KVAR	0 KVAR	0 KVAR	0	0	0	0	0
11		0 KVAR	0 KVAR	0 KVAR	0 KVAR	0 KVAR	0 KVAR	0	0	0	0	0
12												
13												

### Example 5 – Data File opened in spreadsheet

	AX	AY	AZ	BA	BB	BC	BD	BE	BF	BG	BH	BI
1	PF3	Unit	PF(SUM)	Unit	PFH	Unit	PHASE1	Unit	PHASE2	Unit	PHASE3	Unit
2		0	0		0		0 Degree		0 Degree		0 Degree	
3		0	0		0		0 Degree		0 Degree		0 Degree	
4		0	0		0		0 Degree		0 Degree		0 Degree	
5		0	0		0		0 Degree		0 Degree		0 Degree	
6		0	0		0		0 Degree		0 Degree		0 Degree	
7		0	0		0		0 Degree		0 Degree		0 Degree	
8		0	0		0		0 Degree		0 Degree		0 Degree	
9		0	0		0		0 Degree		0 Degree		0 Degree	
10		0	0		0		0 Degree		0 Degree		0 Degree	
11		0	0		0		0 Degree		0 Degree		0 Degree	
12												
13												

### Example 6 – Data File opened in spreadsheet

	BJ	BK	BL	BM	BN	BO	BP	BQ	BR	BS	BT	BU
1	WH	Unit	SH	Unit	QH	Unit	FREQ	Unit				
2		0 KWH		0 KVAH		0 KVARH		0 Hz				
3		0 KWH		0 KVAH		0 KVARH		0 Hz				
4		0 KWH		0 KVAH		0 KVARH		0 Hz				
5		0 KWH		0 KVAH		0 KVARH		0 Hz				
6		0 KWH		0 KVAH		0 KVARH		0 Hz				
7		0 KWH		0 KVAH		0 KVARH		0 Hz				
8		0 KWH		0 KVAH		0 KVARH		0 Hz				
9		0 KWH		0 KVAH		0 KVARH		0 Hz				
10		0 KWH		0 KVAH		0 KVARH		0 Hz				
11		0 KWH		0 KVAH		0 KVARH		0 Hz				
12												
13												

Example Graphic Screen 1

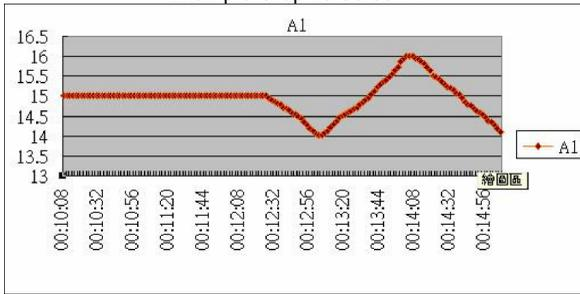

Example Graphic Screen 2

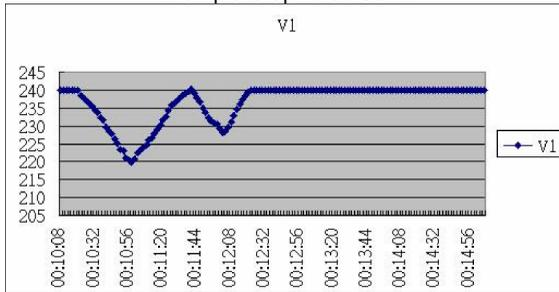

Example Graphic Screen 3

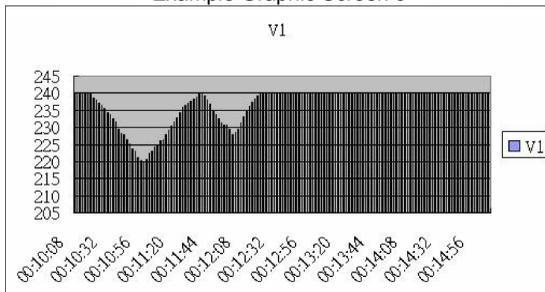

Example Graphic Screen 4

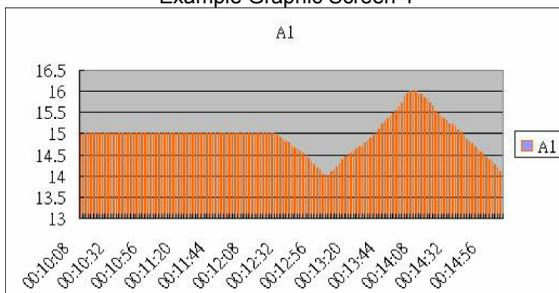

### Example Graphic Screen 5

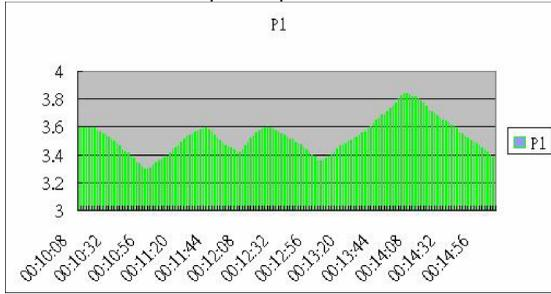

**Copyright © 2013-2015 FLIR Systems, Inc.**

Reservados todos los derechos, incluyendo el derecho de reproducción total o parcial en cualquier medio

**[www.extech.com](http://www.extech.com)**